



**ES**

**2022 TU HERRAMIENTA**

# ÍNDICE PRODUCTOS



## ESTUCHES DE HERRAMIENTAS

7

ESTUCHES DE HERRAMIENTAS



CAJAS HERRAMIENTAS DE ALUMINIO



AUTOCLÉ



SETS DE PUNTAS / VASOS



ESTUCHES PUNTAS



ESTUCHES PUNTAS DESTORNILLADOR



ADAPTADORES



HERRAMIENTAS EN PULGADA



ESTUCHES CON CARRACA



JUEGOS DE VASOS / PUNTAS



ALTO VOLTAJE



## HERRAMIENTAS MANUALES

35

LLAVES



LLAVES EN PULGADA



DESTORNILLADORES



MEDICIÓN



CANDADOS



MARTILLOS



SIERRAS



CINCELES



REMACHADORAS



CARRACAS



BARRAS DE EXTENSIÓN



CORTATUBOS



PELACABLES



ALICATES



LLAVE INGLESA / STILLSON



MORDAZAS



CORTAVARILLAS



## MOBILIARIO DE TALLER

67

CARROS DE HERRAMIENTAS



MÓDULOS



RECAMBIOS PARA CARROS



ARMARIOS



ACCESORIOS



MESAS DE TRABAJO



CAJAS DE HERRAMIENTAS



TABURETES



CAMILLAS



BOLSAS / MOCHILAS



YUNQUES / TORNILLOS DE BANCO



## ELÉCTRICA CON BATERÍA

87

IMPACTO



ATORNILLADOR



TALADRO



MARTILLO DE ROTACIÓN



PULIDORA



AMOLADORA



SIERRAS



ILUMINACIÓN LED



VARIOS



PARA JARDINERÍA



BATERÍAS / CARGADORES



ACCESORIOS / MOCHILAS







## ILUMINACIÓN

113

PORTÁTILES DE TALLER



PORTÁTILES DE LUZ FRONTAL



LUPAS LED



LÁMPARAS INSPECCIÓN



ALINEADOR FAROS



BALIZA DE EMERGENCIA



GIROFAROS



AVISADORES ACÚSTICOS



FAROS DE TRABAJO



PARA REMOLQUE



LÁMPARAS TURISMO



## HERRAMIENTAS NEUMÁTICAS

131

PISTOLAS DE IMPACTO



CARRACAS



CORTADORA



AMOLADORAS



TALADROS



LIJADORAS ORBITALES



KITS PULIDORAS



PISTOLAS DE AIRE



CARRETES DE AIRE



CONECTORES



## ÚTILES Y VASOS DE IMPACTO

151

VASOS DE IMPACTO



PUNTAS DE IMPACTO



ADAPTADORES



BARRAS DE EXTENSIÓN



VASOS EN DESPIECE



VASOS PARA VEHÍCULOS PESADOS



## CARROCERÍA

161

PARA CHAPISTA



PARA FAROS



SETS PALANCAS



MORDAZAS



PISTOLAS SILICONA



VENTOSAS



CINTAS SUJECIÓN



CARRO ALMACENAJE



CABALLETES



MANTENIMIENTO DEL VEHÍCULO



## FRENOS

177

REPOSICIONADOR



REPARACIÓN/MANTENIMIENTO



ALICATE ESPECIAL FRENOS



COMPROBADOR LÍQUIDO DE FRENOS



SANGRADOR LÍQUIDO DE FRENOS





## UTILLAJE

181

FILTROS



ACEITE



INYECCIÓN



CALENTADORES



EXTRACTORES



ESCAPE



DINAMOMÉTRICAS



MEDICIÓN



HERRAMIENTAS ESPECIALES



AIRE ACONDICIONADO



SISTEMA DE REFRIGERACIÓN



## KITS DE CALADO (TIMING TOOLS)

219

BMW, MERCEDES, VAG, RENAULT, NISSAN, FORD, MAZDA, JAGUAR, LAND ROVER, OPEL, VAUXHALL, CITROËN, PEUGEOT...

CARROS DE HERRAMIENTAS CON KITS DE CALADO



## ACCESORIOS LUBRICANTES

243

CUBETOS PARA BIDONES



PARA UREA AUS32



BOMBAS SUMINISTROS GASOIL



BOMBAS DE LLENADO SISTEMA TRANSMISIÓN



EXTRACTOR ACEITE / COMBUSTIBLE



PISTOLAS DE SUCCIÓN



PISTOLAS ENGRASADORAS



VARIOS



## HERRAMIENTAS HIDRÁULICAS

255

GATOS HIDRÁULICOS



GATOS BOTELLA



GATOS DE TALLER



PORTA RUEDAS



PRENSAS



GRÚAS



SOPORTES PARA MOTORES



MESAS HIDRÁULICAS



TRANSPALLET MANUAL



## HERRAMIENTAS ELÉCTRICAS

267

CABLES DE ARRANQUE



ARRANCADOR DE VEHÍCULOS



CARGADORES DE BATERÍA



COMPROBADORES BATERÍA



LIMPIADORAS DE PIEZAS



ASPIRADORES INDUSTRIALES



PULVERIZADORES



HIDROLIMPIADORAS



AMOLADORAS ELÉCTRICAS



CARRETES CABLE ELÉCTRICO



VENTILADORES







## ENERGÍA RENOVABLE Y MOVILIDAD DEL FUTURO

281

ESTACIÓN DE ENERGÍA PORTÁTIL



PANEL SOLAR



COCHE ELÉCTRICO



DISTANCIA DE SEGURIDAD



ALTA TENSIÓN



## ACCESORIOS

285

ACCESORIOS DE TALLER



KITS EMERGENCIA



SENSORES DE APARCAMIENTO



AUTOMOCIÓN



ESCOBILLAS LIMPIAPARABRISAS



CONTRAPESAS



PARA NEUMÁTICOS



TUBOS FLEXIBLES



## SEGURIDAD Y EPIS

307

EPIS



CÁMARAS TÉRMICAS Y TERMÓMETROS



DETERGENTE DE SUPERFICIES



LIMPIADORES Y FÓRMULAS HIDROALCOHÓLICAS



DISPENSADORES



DISTANCIA DE SEGURIDAD



DESINFECCIÓN DE ESPACIOS



MEDIDOR DE OZONO



## CONSUMIBLES

317

PASACABLES



PASADORES



CHAVETAS



TPORNILLOS Y TUERCAS



REMACHES



ARANDELAS



JUNTAS TÓRICAS



TUBOS TERMORETRÁCTILES



ENGRASADORES



FUSIBLES



TERMINALES



CLIPS



## ROPA LABORAL

339

CHAQUETAS



CHALECOS



DISPOSITIVOS ELECTRÓNICOS



DEPORTE EN CASA



PARA EL HOGAR



EXPOSITORES



PACKAGING



341

## PROMOCIONALES

JBM





**JBM** es una empresa dedicada a la **distribución de herramientas profesionales.**

Somos una marca líder española dirigida a la industria y automoción.

**JBM** también tiene un departamento dedicado exclusivamente a los suministros del mercado de accesorios de automóviles, equipando directamente a algunos fabricantes.

Ofreciendo una gama completa de más de **5.000** productos desde 1994, la empresa cuenta con más de **30 años de experiencia.**

Con una **sólida red de distribución** conseguida durante estos años, JBM puede servir eficaz y rápidamente por todo el mundo.

*Exportamos a más de **55 países** por todo el mundo*



**+12.000** EUROPALETS EN STOCK

**x4** ROTACIÓN ANUAL

**+3.500** PRODUCTOS EN CATÁLOGO

**+450** NUEVOS PRODUCTOS EN 2022



Todo el catálogo de JBM en tu bolsillo

**APP JBM**



Consulta todas las características de los productos JBM donde quieras y cuando quieras.

Para estar al día de las últimas novedades y todas las promociones.



DESCÁRGATELA



[www.jbmcamp.com](http://www.jbmcamp.com)





ESTUCHES DE HERRAMIENTAS

9



CAJAS HERRAMIENTAS DE ALUMINIO

21



AUTOCLÉ

24



SETS DE PUNTAS / VASOS

25



ESTUCHES PUNTAS

27



ESTUCHES DE PUNTAS DESTORNILLADOR

29



ADAPTADORES

29



HERRAMIENTAS EN PULGADA

30



ESTUCHES CON CARRACA

31



JUEGOS DE VASOS / PUNTAS

31



ALTO VOLTAJE

33



# ESTUCHES DE HERRAMIENTAS



**SERIE329**

# ¡NUEVO ESTUCHE!

ACABADOS DE ALTA CALIDAD



CIERRE METÁLICO MEJORADO



MANGO ACABADO EN GOMA PARA UNA MEJOR SUJECIÓN



ESTUCHE SERIGRAFIADO CON EL LOGOTIPO JBM





DIVISIBLE EN DOS PARA UNA MEJOR ORGANIZACIÓN





# ESTUCHE DE HERRAMIENTAS DE 216 PIEZAS CON VASOS HEXAGONALES

**54034** 10,75 2 48  
178,00€     
CINCADO

**54045** 11,01 2 48  
179,00€     
CROMADO





CrV **216**  
PCS















**54034**  
  
DESPIECE  
DISPONIBLE



**54045**  
  
DESPIECE  
DISPONIBLE

## CONTIENE

	<b>1/2"</b> x14	13, 14, 15, 16, 17, 18, 19, 20, 21, 22, 24, 27, 30, 32mm
	<b>3/8"</b> x10	10, 11, 12, 13, 14, 15, 16, 17, 18, 19mm
	<b>1/4"</b> x13	4, 4.5, 5, 5.5, 6, 7, 8, 9, 10, 11, 12, 13, 14mm
	<b>1/2"</b> x5	16, 17, 18, 19, 22mm
	<b>3/8"</b> x6	10, 11, 12, 13, 14, 15mm
	<b>1/4"</b> x7	4, 5, 6, 7, 8, 9, 10mm
	<b>1/2"</b> x3	E20, E22, E24
	<b>3/8"</b> x6	E10, E11, E12, E14, E16, E18
	<b>1/4"</b> x5	E4, E5, E6, E7, E8
	<b>T2</b> x3	1/2" - 3/8" - 1/4"
	<b>1/2"</b> x2	125, 250mm
	<b>3/8"</b> x1	125mm
	<b>1/4"</b> x2	50, 100mm
	x3	1/2" - 3/8" - 1/4"
	<b>1/2"</b> x1	adaptador 3/8" (H) - 1/2" (M)

	<b>1/2"</b> x1	8mm
	<b>3/8"</b> x1	8mm
	<b>1/4"</b> x1	6mm
	<b>1/2"</b> x2	16, 21mm
	<b>3/8"</b> x1	18mm
	<b>1/2"</b> x12	8, 9, 10, 11, 12, 13, 14, 15, 16, 17, 18, 19mm
	<b>1/2"</b> x7	1.27, 1.5, 2, 2.5, 3, 4, 5mm
	<b>1/4"</b> x1	
	<b>1/4"</b> x1	
	<b>1/2"</b> x1	T70
	<b>1/2"</b> x1	14mm
	x3	PH0, PH1, PH2
	x3	PZ0, PZ1, PZ2
	x4	3, 4, 5, 6mm
	x4	SL4, SL5.5, SL6.5, SL7
	x8	T8, T9, T10, T15, T20, T25, T27, T30
	x8	T8, T9, T10, T15, T20, T25, T27, T30

	<b>8mm</b> x4	7, 8, 10, 12mm
	<b>6mm</b> x6	2, 2.5, 3, 4, 5, 6mm
	<b>8mm</b> x3	SL8, SL10, SL12
	<b>8mm</b> x3	PH2, PH3, PH4
	<b>8mm</b> x3	PZ2, PZ3, PZ4
	<b>8mm</b> x5	T40, T45, T50, T55, T60
	<b>6mm</b> x3	T5, T6, T7
	<b>8mm</b> x5	T40, T45, T50, T55, T60
	<b>6mm</b> x1	T7
	<b>8mm</b> x4	M10, M11, M12, M13
	<b>6mm</b> x5	M5, M6, M7, M8, M9
	<b>8mm</b> x2	M10, M12
	<b>6mm</b> x3	M5, M6, M8
	<b>8mm</b> x1	TS50
	<b>6mm</b> x8	TS10, TS15, TS20, TS25, TS27, TS30, TS40, TS45
	x4	0, 1, 2, 3mm
	x3	6, 8, 10mm
	<b>6mm</b> x4	4, 6, 8, 10mm
	x3	1, 2, 3mm
	x4	1, 2, 3, 4mm
	<b>6mm</b> x1	1/4"

# ESTUCHE DE HERRAMIENTAS DE 179 PIEZAS CON VASOS HEXAGONALES

**54035**

8,95 2 48

149,00€



CINCADO

**54046**

8,95 2 48

150,00€



CROMADO

CrV

179  
PCS



**54035**



DESPIECE  
DISPONIBLE

**54046**



DESPIECE  
DISPONIBLE

## CONTIENE

	<b>1/2"</b> x17	10, 11, 12, 13, 14, 15, 16, 17, 18, 19, 20, 21, 22, 24, 27, 30, 32mm
	<b>3/8"</b> x10	10, 11, 12, 13, 14, 15, 16, 17, 18, 19mm
	<b>1/4"</b> x13	4, 4.5, 5, 5.5, 6, 7, 8, 9, 10, 11, 12, 13, 14mm
	<b>1/2"</b> x5	16, 17, 18, 19, 22mm
	<b>3/8"</b> x6	10, 11, 12, 13, 14, 15mm
	<b>1/4"</b> x7	4, 5, 6, 7, 8, 9, 10mm
	<b>1/2"</b> x2	E20, E24
	<b>3/8"</b> x6	E10, E11, E12, E14, E16, E18
	<b>1/4"</b> x5	E4, E5, E6, E7, E8
	<b>T2</b> x3	1/2" - 3/8" - 1/4"
	<b>1/2"</b> x1	125mm
	<b>3/8"</b> x1	125mm
	<b>1/4"</b> x2	50, 100mm
	<b>1/2"</b> x1	250mm

	x3	1/2" - 3/8" - 1/4"
	<b>1/2"</b> x2	16, 21mm
	<b>3/8"</b> x1	18mm
	<b>1/2"</b> x1	8mm
	<b>3/8"</b> x1	8mm
	<b>1/4"</b> x1	6mm
	x7	1,27, 1,5, 2, 2,5, 3, 4, 5mm
	x1	1/4"
	x1	1/4"
	x3	PH1, PH2, PH3
	x3	PZ1, PZ2, PZ3
	<b>1/4"</b> x5	2, 3, 4, 5, 6mm
	x3	SL4, SL5.5, SL7
	x8	T8, T9, T10, T15, T20, T25, T27, T30
	x8	T8, T9, T10, T15, T20, T25, T27, T30

	<b>6mm</b>	x11	T5, T6, T7, T8, T9, T10, T15, T20, T25, T27, T30
		x9	T7, T10, T15, T20, T25, T27, T30, T40, T45
		x5	M5, M6, M7, M8, M9
		x3	M5, M6, M8
		x2	PH3, PH4
		x2	PZ3, PZ4
	<b>8mm</b>	x8	7, 8, 10, 12, 14mm
		x3	SL8, SL10, SL12
		x6	T40, T45, T50, T55, T60, T70
		x6	T40, T45, T50, T55, T60, T70



# ESTUCHE DE HERRAMIENTAS DE 113 PIEZAS CON VASOS DE 12 CANTOS

**54036**

6,55 3 108

99,00€



CINCADO

**54047**

7,06 3 108

100,00€



CROMADO

CrV

113  
PCS



**54036**



DESPIECE  
DISPONIBLE

**54047**



DESPIECE  
DISPONIBLE

## CONTIENE

	<b>1/2"</b>	x17	10, 11, 12, 13, 14, 15, 16, 17, 18, 19, 20, 21, 22, 24, 27, 30, 32mm
	<b>1/4"</b>	x13	4, 4.5, 5, 5.5, 6, 7, 8, 9, 10, 11, 12, 13, 14mm
	<b>1/2"</b>	x5	14, 15, 17, 19, 22mm
	<b>1/4"</b>	x8	6, 7, 8, 9, 10, 11, 12, 13mm
	<b>1/2"</b>	x8	E10, E11, E12, E14, E16, E18, E20, E24
	<b>1/4"</b>	x5	E4, E5, E6, E7, E8
		x2	1/2" - 1/4"
	<b>1/2"</b>	x2	125, 250mm
	<b>1/4"</b>	x2	50, 100mm

	x2	1/2" - 1/4"
	<b>1/2"</b>	x1 adaptador 3/8" (H) - 1/2" (M)
	<b>1/2"</b>	x1 8mm
	x5	7, 8, 10, 12, 14mm
	x3	SL8, SL10, SL12
	<b>8mm</b>	x2 PH3, PH4
	x2	PZ3, PZ4
	x5	T40, T45, T50, T55, T60
	x5	5, 6, 8, 10, 12mm

	<b>1/2"</b>	x2	16, 21mm
	x3	1.5, 2, 2.5mm	
	x1	1/4"	
	x1	1/4"	
	x2	PH1, PH2	
	x2	PZ1, PZ2	
	<b>1/4"</b>	x4	3, 4, 5, 6mm
	x3	SL4, SL5.5, SL6.5	
	x8	T8, T10, T15, T20, T25, T27, T30	

# ESTUCHE DE HERRAMIENTAS DE 108 PIEZAS CON VASOS HEXAGONALES

**54037**

6,58 3 108

88,00€



CINCADO

**54048**

7 3 108

89,00€



CROMADO

CrV

108  
PCS

54048



DESPIECE  
DISPONIBLE

54037



DESPIECE  
DISPONIBLE



## CONTIENE

	<b>1/2"</b>	x17	10, 11, 12, 13, 14, 15, 16, 17, 18, 19, 20, 21, 22, 24, 27, 30, 32mm
	<b>1/4"</b>	x13	4, 4.5, 5, 5.5, 6, 7, 8, 9, 10, 11, 12, 13, 14mm
	<b>1/2"</b>	x5	14, 15, 17, 19, 22mm
	<b>1/4"</b>	x8	6, 7, 8, 9, 10, 11, 12, 13mm
	<b>1/2"</b>	x8	E10, E11, E12, E14, E16, E18, E20, E24
	<b>1/4"</b>	x5	E4, E5, E6, E7, E8
	<b>T2</b>	x2	1/2" - 1/4"
	<b>1/2"</b>	x2	125, 250mm
	<b>1/4"</b>	x2	50, 100mm
		x2	1/2" - 1/4"
	<b>1/2"</b>	x1	adaptador 3/8" (H) - 1/2" (M)

	<b>1/2"</b>	x2	16, 21mm
	<b>1/2"</b>	x1	8mm
		x3	1.5, 2, 2.5mm
		x1	1/4"
		x1	1/4"
		x2	PH3, PH4
		x2	PZ3, PZ4
	<b>8mm</b>	x5	7, 8, 10, 12, 14mm
		x3	SL8, SL10, SL12
		x5	T40, T45, T50, T55, T60

		x2	PH1, PH2
		x2	PZ1, PZ2
	<b>1/4"</b>	x4	3, 4, 5, 6mm
		x3	SL4, SL5.5, SL6.5
		x8	T8, T10, T15, T20, T25, T27, T30



# ESTUCHE DE HERRAMIENTAS DE 94 PIEZAS CON VASOS HEXAGONALES

**54038**

86,00€

6 3 108



CINCADO

**54049**

87,00€

6,47 3 108



CROMADO

CrV

94  
PCS



**54038**



DESPIECE  
DISPONIBLE

**54049**



DESPIECE  
DISPONIBLE

## CONTIENE

	<b>1/2"</b>	x18	10, 11, 12, 13, 14, 15, 16, 17, 18, 19, 20, 21, 22, 23, 24, 27, 30, 32mm
	<b>1/4"</b>	x13	4, 4.5, 5, 5.5, 6, 7, 8, 9, 10, 11, 12, 13, 14mm
	<b>1/2"</b>	x4	14, 15, 17, 19mm
	<b>1/4"</b>	x8	6, 7, 8, 9, 10, 11, 12, 13mm
	<b>TZ</b>	x2	1/2" - 1/4"
	<b>1/2"</b>	x2	125, 250mm
	<b>1/4"</b>	x2	50, 100mm
		x2	1/2" - 1/4"
	<b>1/2"</b>	x1	adaptador 3/8" (H) - 1/2" (M)

	<b>1/2"</b>	x1	8mm
		x3	1.5, 2, 2.5mm
	<b>1/2"</b>	x2	16, 21mm
		x2	PH3, PH4
		x2	PZ3, PZ4
	<b>8mm</b>	x4	8, 10, 12, 14mm
		x3	SL8, SL10, SL12
		x4	T40, T45, T50, T55
	<b>8mm</b>	x1	1/4"

		x1	1/4"
		x1	1/4"
		x1	1/4"
		x2	PH1, PH2
		x2	PZ1, PZ2
	<b>1/4"</b>	x4	3, 4, 5, 6mm
		x3	SL4, SL5.5, SL7
		x6	T8, T10, T15, T20, T25, T30

## ESTUCHE DE HERRAMIENTAS DE 74 PIEZAS CON VASOS DE 12 CANTOS

53074

5,09 3 108

78,00€

Kg 11 108

CROMADO



74  
PCS

CrV



DESPIECE  
DISPONIBLE

### CONTIENE

	1/2"	x18	10, 11, 12, 13, 14, 15, 16, 17, 18, 19, 20, 21, 22, 23, 24, 27, 30, 32mm
	1/4"	x10	4, 5, 5.5, 6, 7, 8, 10, 11, 12, 13mm
	72	x2	1/2" - 1/4"
	1/2"	x2	125, 250mm
	1/4"	x1	100mm
		x1	1/2"

	1/2"	x1	adaptador 3/8" (H) - 1/2" (M)
	1/2"	x1	21mm
		x3	1.5, 2, 2.5mm
		x1	1/4"
	1/4"	x1	6mm

		x5	PH0, PH1, PH2, PH3, PH4
		x5	PZ0, PZ1, PZ2, PZ3, PZ4
	6mm	x6	3, 4, 5, 6, 8, 10mm
		x5	SL3, SL4, SL5.5, SL6, SL7
		x8	T8, T10, T15, T20, T25, T27, T30, T40
		x4	4, 5, 6, 7mm

## ESTUCHE DE VASOS Y PUNTAS DE 130 PIEZAS

53953

1,50 10 420

29,00€

Kg 11 420

CINCADO

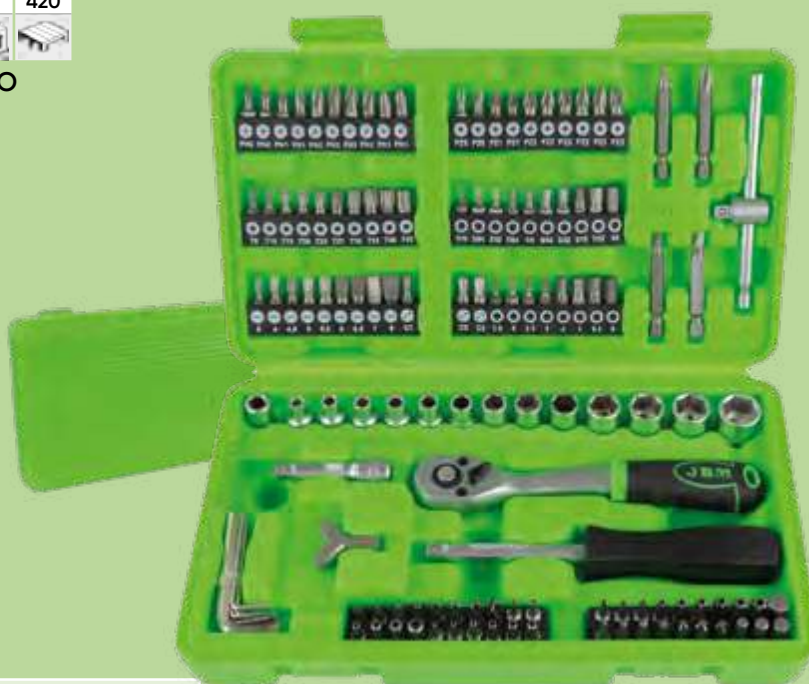

CrV

130  
PCS

1/4"



EN EXPOSITOR  
DE 10 UNIDADES

### CONTIENE

	1/4"	x13	4, 4.5, 5, 5.5, 6, 7, 8, 9, 10, 11, 12, 13, 14mm
	72	x1	1/4"
	1/4"	x1	50mm
		x1	1/4"
	1/4"	x1	8mm
		x1	1/4"
		x1	1/4"
	1/4"	x7	1.27, 1.5, 2, 2.5, 3, 4, 5mm

	25mm	x10	1/16, 5/64, 3/32, 7/64, 1/8, 9/64, 5/32, 3/16, 7/32, 1/4
		x8	1.5, 2, 2.5, 3, 4, 5, 5.5, 6mm
		x6	5/64, 3/32, 7/64, 1/8, 9/64, 5/32
	25mm	x6	2, 2.5, 3, 4, 5, 6mm
	25mm	x9	3, 4, 4.5, 5, 5.5, 6, 6.5, 7, 8mm
	50mm	x2	4, 6mm
	25mm	x10	PH0(x2), PH1(x2), PH2(x4), PH3(x2)
	50mm	x2	PH1, PH2
	25mm	x10	PZ0(x2), PZ1(x2), PZ2(x4), PZ3(x2)

	25mm	x10	T8, T10, T15, T20, T25, T27, T30, T35, T40, T45
	25mm	x9	T8, T10, T15, T20, T25, T27, T30, T35, T40
	25mm	x3	M5, M6, M8
	25mm	x3	6, 8, 10mm
	25mm	x3	C1, C2, C3
	25mm	x4	1, 2, 3, 4mm
	25mm	x4	4, 6, 8, 10mm
	25mm	x4	0, 1, 2, 3mm



## ESTUCHE DE HERRAMIENTAS 3/8" DE 59 PIEZAS CON VASOS DE 12 CANTOS

53075

49,90€

2,57 10 180



CROMADO



CrV

59  
PCS



DESPIECE  
DISPONIBLE

### CONTIENE

	3/8"	x17	6, 7, 8, 9, 10, 11, 12, 13, 14, 15, 16, 17, 18, 19, 20, 21, 22mm
	T2	x1	3/8"
	3/8"	x2	75, 150mm
	3/8"	x1	8mm
	3/8"	x1	8mm

	x1	3/8"
	x2	PH3, PH4
	x2	PZ3, PZ4
	x5	7, 8, 10, 12, 14mm
	x3	8, 10, 12mm
	x5	T40, T45, T50, T55, T60

	x1	1/4"
	x2	PH1, PH2
	x2	PZ1, PZ2
	x4	3, 4, 5, 6mm
	x3	4, 5,5, 6,5mm
	x7	T8, T10, T15, T20, T25, T27, T30

## ESTUCHE DE HERRAMIENTAS 3/8" DE 59 PIEZAS CON VASOS HEXAGONALES

51819

48,00€

2,55 10 180



CINCADO

53219

49,00€

2,60 10 180



CROMADO



CrV

59  
PCS



51819



DESPIECE  
DISPONIBLE

53219



DESPIECE  
DISPONIBLE

### CONTIENE

	3/8"	x17	6, 7, 8, 9, 10, 11, 12, 13, 14, 15, 16, 17, 18, 19, 20, 21, 22mm
	T2	x1	3/8"
	3/8"	x2	75, 150mm
	3/8"	x1	8mm
	3/8"	x1	8mm

	x1	3/8"
	x2	PH3, PH4
	x2	PZ3, PZ4
	x5	7, 8, 10, 12, 14mm
	x3	SL8, SL10, SL12
	x5	T40, T45, T50, T55, T60

	x1	1/4"
	x2	PH1, PH2
	x2	PZ1, PZ2
	x4	3, 4, 5, 6mm
	x3	SL4, SL5,5, SL6,5
	x7	T8, T10, T15, T20, T25, T27, T30

## ESTUCHE DE HERRAMIENTAS CON 56 PIEZAS

**50566**

1,19 10 240

32,00€



CINCADO

**53101**

1,26 10 270

35,00€



CROMADO



CrV

56  
PCS

50566



DESPIECE  
DISPONIBLE

53101



DESPIECE  
DISPONIBLE



CONTIENE

	1/4"	x13	4, 4.5, 5, 5.5, 6, 7, 8, 9, 10, 11, 12, 13, 14mm
	72	x1	1/4"
	1/4"	x2	50, 100mm
		x1	1/4"
		x1	1/4"

	1/4"	x1	1/4"
	1/4"	x1	6mm
		x3	PH0, PH1, PH2
	6mm	x3	PZ0, PZ1, PZ2
		x6	3, 4, 5, 6, 7, 8mm
	6mm	x1	1/4"

		x4	SL4, SL5, SL6, SL7
	6mm	x3	M5, M6, M8
		x8	T8, T10, T15, T20, T25, T27, T30, T40
		x8	T8, T10, T15, T20, T25, T27, T30, T40

## ESTUCHE DE HERRAMIENTAS DE 56 PIEZAS

**53102**

1,28 10 270

39,00€



CROMADO



CrV

56  
PCS



DESPIECE  
DISPONIBLE



CONTIENE

	1/4"	x13	4, 4.5, 5, 5.5, 6, 7, 8, 9, 10, 11, 12, 13, 14mm
	72	x1	1/4"
	1/4"	x2	50, 100mm
		x1	1/4"
		x1	1/4"

	1/4"	x1	1/4"
	1/4"	x1	6mm
		x3	PH0, PH1, PH2
	6mm	x3	PZ0, PZ1, PZ2
		x6	3, 4, 5, 6, 7, 8mm
	6mm	x1	1/4"

		x4	SL4, SL5, SL6, SL7
	6mm	x3	M5, M6, M8
		x8	T8, T10, T15, T20, T25, T27, T30, T40
		x8	T8, T10, T15, T20, T25, T27, T30, T40

## ESTUCHE DE 46 PIEZAS CON VASOS HEXAGONALES

**53201**

1,45 5 10 300

34,00€



CROMADO



DESPIECE  
DISPONIBLE

CrV

46  
PCS



CONTIENE

	x6	3, 4, 5, 6, 7, 8mm		x3	PZ1, PZ2, PZ3
	x3	SL4, SL5.5, SL7		x6	T10, T15, T20, T25, T30, T40
	x3	PH1, PH2, PH3			

	1/4"	x13	4, 4.5, 5, 5.5, 6, 7, 8, 9, 10, 11, 12, 13, 14mm
	72	x1	1/4"
	1/4"	x2	50, 100mm
	1/4"	x1	1/4"
		x4	1.27, 1.5, 2.0, 2.5mm
		x1	1/4"
		x1	1/4"
	1/4"	x1	150mm
	6mm	x1	1/4"



# ESTUCHE DE HERRAMIENTAS DE 61 PIEZAS VASOS SPLINE DE 1/2" Y 1/4"

**52722**

4,63 4 60  
Kg fl

98,00€

CINCADO

**53108**

4,83 3 90  
Kg fl

99,00€

CROMADO



CrV

61  
PCS

- Útil para:



52722



DESPIECE  
DISPONIBLE



53108



DESPIECE  
DISPONIBLE

## CONTIENE

	1/2"	x11	14, 15, 16, 17, 18, 19, 22, 24, 27, 30, 32mm
	1/4"	x12	4, 4.5, 5, 5.5, 6, 7, 8, 9, 10, 11, 12, 13mm
		x2	1/2" - 1/4"
	1/2"	x2	125, 250mm
	1/4"	x2	50, 100mm
		x2	1/2" - 1/4"

	1/2"	x1	adaptador 3/8" (H) - 1/2" (M)
	1/2"	x2	16, 21mm
	1/4"	x1	6mm
		x3	1.5, 2, 2.5mm
		x1	1/4"
		x1	1/4"

		x3	PH1, PH2, PH3
		x3	PZ1, PZ2, PZ3
	6mm	x5	3, 4, 5, 6, 8mm
		x3	SL4, SL5.5, SL7
		x5	T10, T15, T20, T25, T30
	6mm	x1	1/4"

# ESTUCHE DE HERRAMIENTAS DE 21 PIEZAS VASOS DE 1/2"

**53554**

3,15 4 120  
Kg fl

54,00€

CINCADO

**52723**

3,2 4 96  
Kg fl

56,00€

CINCADO

**52721**

3,2 4 108  
Kg fl

55,00€

CINCADO

21  
PCS

CrV

52723

DESPIECE  
DISPONIBLE



53554

DESPIECE  
DISPONIBLE



## CONTIENE

	1/2"	x16	10, 11, 12, 13, 14, 15, 16, 17, 18, 19, 21, 22, 24, 27, 30, 32mm
--	------	-----	--

		x1	1/2"
	1/2"	x2	75, 125mm

	1/2"	x1	
	1/2"	x1	adaptador 3/8" (H) - 1/2" (M)

# ESTUCHE DE HERRAMIENTAS DE 72 PIEZAS CON VASOS HEXAGONALES

**51818**

95,00€

7,25 3 63



CINCADO

**53106**

99,90€

7,2 3 60



CROMADO



CrV

72  
PCS



**53106**



DESPIECE  
DISPONIBLE

**51818**



DESPIECE  
DISPONIBLE

## CONTIENE

	<b>1/2"</b>	x13	10, 11, 12, 13, 14, 15, 17, 19, 22, 24, 27, 30, 32mm		x2	1/2" - 1/4"		x1			
	<b>1/4"</b>	x10	4, 5, 6, 7, 8, 9, 10, 11, 12, 13mm		<b>1/2"</b>	x2	16, 21mm		x1	300gr	
	<b>1/4"</b>	x5	5, 6, 7, 8, 9mm		<b>1/4"</b>	x1	6mm		x1		
	ref. 53106	<b>72</b>	x2	1/2", 1/4"		x8	10, 11, 12, 13, 14, 15, 17, 19mm		x1		
	ref. 51818	<b>24</b>	x2	1/2", 1/4"		x3	1.5, 2, 2.5mm		x1		
	<b>1/2"</b>	x1	125mm		x1	1/4"			x4	SL3, SL4, SL5, SL6	
	<b>1/4"</b>	x1	75mm		x2	PH6x40mm, PH6x100mm			<b>6mm</b>	x3	PH1, PH2, PH3
					x3	SL6x40mm, SL6x100mm, SL8x200mm			x7	T10, T15, T20, T25, T27, T30, T40	

# ESTUCHE DE HERRAMIENTAS 41 PIEZAS CON VASOS HEXAGONALES

**52713**

89,00€

6,3 4 96



41  
PCS

CrV

CINCADO

## CONTIENE

	<b>1/2"</b>	x11	10, 12, 13, 14, 15, 17, 19, 22, 24, 27, 30mm		x1	6"
	<b>1/2"</b>	x2	16, 21mm		x1	20x200mm
	<b>24</b>	x1	1/2"		x1	6-24V, 110mm
	<b>1/2"</b>	x1	125mm		x1	8"
	<b>1/2"</b>	x1			x2	8x10, 12x13mm
	<b>1/2"</b>	x1	adaptador 3/8" (H) - 1/2" (M)		x1	8x10mm
	<b>1/2"</b>	x8	7, 8, 10, 12, 13, 14, 17, 19mm		x1	75x300mm
		x4	6, 8, 10, 12mm		x1	300gr
		x1	PH2x100mm		x1	6x150mm
		x1	SL6x100mm			



DESPIECE  
DISPONIBLE



# ESTUCHE DE HERRAMIENTAS DE 82 PIEZAS CON VASOS HEXAGONALES

53647

99,00€

6,13

Kg

3

fl

108

fl

CROMADO



CrV

82  
PCS



DESPIECE  
DISPONIBLE

## CONTIENE

	1/2"	x12	13, 14, 15, 16, 17, 18, 19, 22, 24, 27, 30, 32mm
	1/4"	x13	4, 4.5, 5, 5.5, 6, 7, 8, 9, 10, 11, 12, 13, 14mm
	72	x2	1/2" - 1/4"
	1/2"	x2	125, 250mm
	1/4"	x2	50, 100mm
		x2	1/2" - 1/4"
	1/2"	x1	adaptador 3/8" (H) - 1/2" (M)

	1/2"	x2	16, 21mm
	1/2"	x1	8mm
		x9	8, 10, 11, 12, 13, 14, 17, 19, 22mm
		x1	150mm
		x1	1/4"
		x1	1/4"

	8mm	x2	PH3, PH4
		x2	PZ3, PZ4
		x4	8, 10, 12, 14mm
		x3	SL8, SL10, SL12
	1/4"	x4	T40, T45, T50, T55
		x1	1/4"
		x2	PH1, PH2
		x2	PZ1, PZ2
		x4	3, 4, 5, 6mm
		x3	SL4, SL5.5, SL7
	1/4"	x6	T8, T10, T15, T20, T25, T30

# CAJA DE HERRAMIENTAS DE HIERRO 64 PCS

53565

258,00€

16,50

Kg

1

fl

19

fl

290mm

495mm

200mm

CrV

64  
PCS

CINCADO



DESPIECE  
DISPONIBLE

## CONTIENE

	1/2"	x18	10, 11, 12, 13, 14, 15, 16, 17, 18, 19, 20, 21, 22, 23, 24, 27, 30, 32mm
	72	x1	1/2"
		x1	1/2"
	1/2"	x3	76mm, 127mm, 254mm
	1/2"	x1	255mm
	1/2"	x1	21mm
		x1	457mm

		x18	6, 7, 8, 9, 10, 11, 12, 13, 14, 15, 16, 17, 18, 19, 20, 21, 22, 24mm
		x9	1.5, 2, 2.5, 3, 4, 5, 6, 8, 10mm
		x3	PH1x100mm, PH2x150mm, PH3x200mm
		x3	SL5x100mm, SL6x150mm, SL8x200mm
		x1	250mm
		x1	180mm
		x1	200mm
		x1	180mm

## INCLUYE:



# ESTUCHE DE HERRAMIENTAS 303 PIEZAS CON VASOS HEXAGONALES

53212

9,45 2 48

188,00€



CrV

303  
PCS

CROMADO



## CONTIENE

	<b>1/2"</b>	x18	10, 11, 12, 13, 14, 15, 16, 17, 18, 19, 20, 21, 22, 23, 24, 27, 30, 32mm
	<b>1/4"</b>	x13	4, 4.5, 5, 5.5, 6, 7, 8, 9, 10, 11, 12, 13, 14mm
		x2	1/2" - 1/4"
	<b>1/2"</b>	x2	125, 250mm
	<b>1/4"</b>	x2	50, 100mm
	<b>1/2"</b>	x1	8mm
	<b>1/4"</b>	x1	6mm
	<b>1/2"</b>	x1	adaptador 3/8" (H) - 1/2" (M)
	<b>1/2"</b>	x2	16, 21mm
		x2	1/2" - 1/4"
		x1	1/4"
		x2	SL3.0 x 50mm, SL2.5 x 50mm
		x3	PH0x50mm, PH00x50mm, PH000x50mm
		x2	SL4.0x100mm, SL6.5x125mm
		x2	PH1x80mm, PH2x100mm

	<b>6mm</b>	x9	1.5, 2, 2.5, 3, 4, 5, 5.5, 6, 8mm
	<b>6mm</b>	x10	1/16, 5/64, 3/32, 7/64, 1/8, 9/64, 5/32, 3/16, 7/32, 1/4
	<b>8mm</b>	x4	H5.5, H6.5, H7, H8
	<b>6mm</b>	x6	5/64, 3/32, 7/64, 1/8, 9/64, 5/32
	<b>6mm</b>	x6	2, 2.5, 3, 4, 5, 6mm
	<b>6mm</b>	x9	SL3, SL4, SL4.5, SL5, SL5.5, SL6, SL6.5, SL7, SL8
	<b>8mm</b>	x4	SL5.5, SL6.5, SL7, SL8
	<b>6mm</b>	x10	PH0 (x2), PH1 (x2), PH2 (x4), PH3 (x2)
	<b>8mm</b>	x2	PH3, PH4
	<b>6mm</b>	x10	PZ0 (x2), PZ1 (x2), PZ2 (x4), PZ3 (x2)
	<b>8mm</b>	x2	PZ3, PZ4
	<b>6mm</b>	x10	T8, T10, T15, T20, T25, T27, T30, T35, T40, T45
	<b>8mm</b>	x8	T25, T27, T30, T35, T40 (x2), T45, T50
	<b>6mm</b>	x9	T8, T10, T15, T20, T25, T27, T30, T35, T40
	<b>6mm</b>	x3	5, 6, 8mm
	<b>8mm</b>	x4	5, 6, 8, 10mm
		x3	6, 8, 10
		x3	C1, C2, C3
	<b>6mm</b>	x4	1, 2, 3, 4
		x4	4, 6, 7, 10mm
		x4	S0, S1, S2, S3

	x7	1.27, 1.5, 2, 2.5, 3, 4, 5mm	
	x13	1.5, 2, 2.5, 3, 3.2, 3.5, 4, 4.5, 4.8, 5, 5.5, 6, 6.5mm	
	x1		x1
	x1		x1
	x10		x1 300g
	x1	8"	x1
	x1	3m	
	x6	SL1.5, SL2, SL2.5, SL3, SL3.5, SL4	
	x4	PH000, PH00, PH0, PH1	
	x2	PZ0, PZ1	
	x8	T5, T6, T7, T8, T9, T10, T15, T20	
	x1		
	x23		
	x22		
	x10		
	x10		



DESPIECE DISPONIBLE



# CAJAS DE HERRAMIENTAS DE ALUMINIO

## CAJA DE HERRAMIENTAS DE 159 PIEZAS

53159

279,00€

13,3

Kg

1

fl

32

fl



CrV

1/2"

1/4"

159  
PCS

CINCADO



DESPIECE  
DISPONIBLE



### CONTIENE



	1/2"	x14	14, 15, 16, 17, 18, 19, 20, 21, 22, 23, 24, 27, 30, 32mm
	1/4"	x10	4, 5, 6, 7, 8, 9, 10, 11, 12, 13mm
	72	x2	1/4" - 1/2"
	1/2"	x2	50, 100mm
	1/4"	x2	125, 250mm
	1/4"	x1	150mm
		x2	1/4" - 1/2"
	1/2"	x1	adaptador 3/8" (H) - 1/2" (M)
		x2	1/4" - 1/2"
	1/4"	x1	250mm
	1/4"	x1	110mm
	1/2"	x2	16, 21mm
		x1	1/4"

		x9	8, 10, 11, 12, 13, 15, 17, 19, 22mm
		x9	1,5, 2, 2,5, 3, 4, 5, 6, 8, 10mm
		x1	100-250V
		x1	
		x2	PH1×80, PH2×10mm
		x4	SL3×75, SL4×100, SL6.5×125, SL8×150mm
		x1	PH00×50mm
		x1	SL2.5×50mm
		x1	250mm
		x1	160mm
		x1	180mm
		x1	160mm
		x1	200mm
		x1	7" (180mm)
		x1	220mm
		x1	160mm

		x1	
		x6	1,5mm
		x1	
		x1	300gr
		x1	3m
		x1	200mm
		x5	
		x1	18mm
		x10	
		x40	6.35mm
		x15	8mm

# CAJAS DE HERRAMIENTAS DE ALUMINIO

## ESTUCHE DE HERRAMIENTAS DE 198 PIEZAS CON VASOS HEXAGONALES

53928

13,50	1	32

258,00€

CROMADO



CrV

1/2"

1/4"

198  
PCS

CINCADO



DESPIECE  
DISPONIBLE

### CONTIENE



	1/2"	x10	10, 11, 12, 13, 14, 15, 17, 19, 22, 24mm
	1/4"	x9	4, 5, 6, 7, 8, 9, 10, 11, 12mm
		x2	1/2" - 1/4"
	1/2"	x2	125, 250mm
	1/4"	x2	50, 100mm
	x2	1/2" - 1/4"	
	1/2"	x1	adaptador 3/8" (H) - 1/2" (M)
	x1	1/4"	
	1/4"	x1	6mm
	1/2"	x2	16, 21mm

	x9	1,5, 2, 2,5, 3, 4, 5, 6, 8, 10mm
	x9	8, 10, 11, 12, 13, 14, 17, 19, 22mm
	x2	PH1x80mm, PH2x100mm
	x4	SL3.0x75mm, SL4.0x100mm, SL6.5x125mm, 8x150mm
	x1	PH00, SL2
	x1	PH000, SL1.5
	x1	T6, T10
	x30	6.35mm
	x1	
	x60	
	x11	
	x10	

	x1	100-250V		x1	250mm
	x1	200mm		x1	180mm
	x1	200mm		x1	180mm
	x1	160mm		x1	150mm
	x1	200mm		x1	
	x4			x5	
	x1			x1	300gr.
	x1	18mm		x1	
	x1			x1	
	x1			x1	5m



# CAJAS DE HERRAMIENTAS DE ALUMINIO

## CAJA DE HERRAMIENTAS DE 108 PIEZAS

<b>53158</b>	8,60	1	32	3/8"	1/4"	<b>53444</b>	8,2	1	36	1/2"	1/4"
148,00€	Kg	fl	fl			158,00€	Kg	fl	fl		

	CrV	<b>108</b> PCS
1/2"	3/8"	1/4"

CINCADO



**53158**

DESPIECE DISPONIBLE

**53444**

DESPIECE DISPONIBLE



### CONTIENE



	1/4"	x8	4, 4.5, 5, 5.5, 6, 7, 8, 9mm
	3/8"	x9	10, 11, 12, 13, 14, 15, 17, 18, 19mm
	1/2"	x1	
	ref. 53158	x1	3/8"
	ref. 53444	x1	1/2"
	3/8"	x2	75, 150mm
	1/2"	x2	
	1/4"	x1	adaptador 3/8" (H) - 1/4" (M)
	1/4"	x1	25mmL
	1/4"	x1	

	3/8"	x1	16mm
		x2	6x7, 8x9, 10x11, 12x13, 14x15, 16x17, 18x19, 20x22mm
			1.5, 2, 2.5, 3, 4, 5, 6, 8, 10mm
		x2	PH1x80, PH2x100mm
		x4	SL3.5x75, SL4x100, SL6.5x125, SL8x150mm
		x1	PH00x50mm
		x1	SL2.5x50mm

	x1	100-250V		x1	
	x1	250mm		x6	1.5mm
	x1	180mm		x1	300gr
	x1	160mm		x31	
	x1	160mm		x1	
	x1	220mm		x1	7"
	x1	18mm		x1	3m
	x10				

## ESTUCHE METÁLICO CON 22 PIEZAS DE AUTOCLÉ DE 1"

**51616**

43,45 1 24



359,00€



**51855**

41,1 1 24



359,00€



CrV

1"

22  
PCS

CINCADO

CAJA METÁLICA

**51616**



DESPIECE DISPONIBLE

**51855**



DESPIECE DISPONIBLE

### CONTIENE

	1"	x17	36, 38, 41, 46, 50, 54, 55, 58, 60, 63, 65, 67, 70, 71, 75, 77, 80mm
	1"	x1	650mm
	1"	x2	205, 410mm
	x1 1"		x1 1"

## ESTUCHE DE HERRAMIENTAS DE AUTOCLÉ DE 3/4"

**53727**

14,65 1 40



188,00€



3/4"

21  
PCS

CrV

CINCADO

**53728**

13,9 1 40



188,00€



### CONTIENE

	3/4"	x16	19, 21, 22, 23, 24, 26, 27, 29, 30, 32, 35, 36, 38, 41, 46, 50mm
	3/4"	x1	495mm
	3/4"	x3	100, 200, 400mm
	3/4"	x1	445mm

**53728**

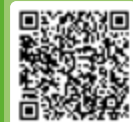

DESPIECE DISPONIBLE

**53727**



DESPIECE DISPONIBLE

## ESTUCHE DE HERRAMIENTAS DE 39 PIEZAS HEX. DE PERFIL BAJO

**52418**

3,61 5 100



144,00€



39  
PCS

CrV

CROMADO

### CONTIENE

	13mm	x12	4, 4.5, 5, 5.5, 6, 7, 8, 9, 10, 11, 12, 13mm
	19mm	x10	10, 11, 12, 13, 14, 15, 16, 17, 18, 19mm
	22mm	x5	20, 21, 22, 23, 24mm
	22mm - 1/2"	x3	27, 30, 32mm
		x3	13, 19, 22mm
	1/4"	x1	13mm
	3/8"	x1	19mm
	1/2"	x1	22mm
		x3	13, 19, 22mm



## ESTUCHE 15 PIEZAS CON VASOS PARA ESPÁRRAGOS

51617

67,50€

1,06 18 320

Kg fl



CrV

3/8"

15  
PCS

CROMADO



OCUPA EL  
MÍNIMO ESPACIO



CONTIENE

		19mm x10	10, 11, 12, 13, 14, 15, 16, 17, 18, 19mm
		19mm x1	75mm
		x2	1/4" 3/8"
		72 19mm x1	180mm



## ESTUCHE 17 PIEZAS CON VASOS PARA ESPÁRRAGOS

50623

53,50€

0,63 10 320

Kg fl



CrV

1/4"

17  
PCS

CROMADO



OCUPA EL  
MÍNIMO ESPACIO

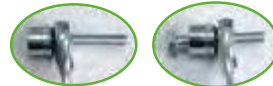

CONTIENE

		13mm x13	4, 4.5, 5, 5.5, 6, 7, 8, 9, 10, 11, 12, 13, 14mm
		13mm x1	75mm
		x1	1/4"
		72 13mm x1	145mm



## SET DE 6 VASOS 1/2" TORX TIPO E EXTRA LARGOS

53915

57,50€

2 10

Kg fl

CINCADO

CONTIENE

		1/2" x6	E10, E12, E14, E16, E18, E20
--	--	---------	------------------------------



E12 Llave de vaso para culata de BMW:  
- Motor M42, 1.8L, 4 cilindros, 16V, modelo 318 is desde 1989  
- Motor M50, 2.0L, 2.5L, 6 cilindros, 24V, modelo 520i, 525i desde 1991



CABEZAL DE LOS  
VASOS EN ACABADO  
EN NEGRO

140mm



6  
PCS

1/2"

CrV



## SET DE 28 VASOS TORX CORTOS Y LARGOS

51930

39,00€

2,19 10 240

Kg fl

CINCADO

53061

41,00€

2,19 5 10 180

Kg fl

CROMADO



1/4"

3/8"

1/2"

28  
PCS

CrV

CONTIENE

		1/4" x5	E4, E5, E6, E7, E8
		3/8" x5	E10, E11, E12, E14, E16
		1/2" x4	E18, E20, E22, E24
		1/4" x5	E4, E5, E6, E7, E8
		3/8" x5	E10, E11, E12, E14, E16
		1/2" x4	E18, E20, E22, E24

51930



DESPIECE  
DISPONIBLE



53061



DESPIECE  
DISPONIBLE

## SET 12 PIEZAS 1/2" PUNTA TORX

51261

1,62 10 360

34,00€



CINCADO

51261



DESPIECE DISPONIBLE

1/2"

12 PCS

CrV



53103

1,80 5 10 330

36,00€



CROMADO

CONTIENE

1/2"	x6	T20, T25, T30, T40, T45, T50
	x1	T55
	x5	T60, T70, T80, T90, T100

## SET 12 PIEZAS 1/2" PUNTA 12 CANTOS

51384

1,55 10 360

34,00€



CINCADO

51384



DESPIECE DISPONIBLE

12 PCS

1/2"

CrV



53104

1,75 10 240

36,00€



CROMADO

CONTIENE

1/2"	x6	M4, M5, M6, M7, M8, M9
	x1	M10
	x5	M12, M14, M16, M18, M20

## SET 12 PIEZAS 1/2" PUNTA HEXAGONAL

51260

1,92 10 360

34,00€



CINCADO

51260



DESPIECE DISPONIBLE

12 PCS

1/2"

CrV



53105

2,10 10 240

36,50€



CROMADO

CONTIENE

1/2"	x6	H5, H6, H7, H8, H10, H12
	x1	H14
	x5	H16, H17, H18, H19, H22

## SET 6 PIEZAS 1/2" PUNTA TORX INVIOLEBLE

51410

0,38 5 20 500

36,00€



T55, T60, T70, T80, T90, T100

1/2"

CrV

6 PCS



## SET 6 PIEZAS 1/2" PUNTA 12 CANTOS INVIOLEBLE / PUNTA XZN

51409

0,34 5 20 500

36,00€



M10, M12, M14, M16, M18, M20

1/2"

CrV

6 PCS





## ESTUCHE DE PUNTAS PARA TORNILLOS DE 12 CANTOS Y RIBE

52603

4,07

4

144



26  
PCS

74,00€

52606

5,16

4

144



32  
PCS

88,00€

CrV

1/2"



### CONTIENE



1/2"

x8 55mml	M5, M6, M8, M9, M10, M12, M14, M16
x7 100mml	M5, M6, M8, M9, M10, M12, M14
x7 140mml	M5, M6, M8, M9, M10, M12, M14
x4 200mml	M8, M10, M12, M14

52603



DESPIECE  
DISPONIBLE

### CONTIENE



1/2"

x9 55mml	M5, M6, M7, M8, M9, M10, M12, M13, M14
x9 100mml	M5, M6, M7, M8, M9, M10, M12, M13, M14
x7 140mml	M7, M8, M9, M10, M12, M13, M14
x7 200mml	M7, M8, M9, M10, M12, M13, M14

52606



DESPIECE  
DISPONIBLE

## ESTUCHE DE PUNTAS PARA TORNILLOS HEXAGONALES Y TORX

52604

4,62

4

128



30  
PCS

78,00€

52605

4,67

4

144



32  
PCS

78,00€

CrV

1/2"



### CONTIENE



1/2"

x9 55mml	5, 6, 7, 8, 10, 12, 14, 17, 19mm
x8 100mml	5, 6, 7, 8, 10, 11, 12, 13mm
x7 140mml	5, 6, 7, 8, 10, 12, 14mm
x6 200mml	5, 6, 7, 8, 10, 12mm

52604



DESPIECE  
DISPONIBLE

### CONTIENE



1/2"

x10 55mml	T20, T25, T27, T30, T40, T45, T50, T55, T60, T70
x10 100mml	T20, T25, T27, T30, T40, T45, T50, T55, T60, T70
x6 140mml	T40, T45, T50, T55, T60, T70
x6 200mml	T40, T45, T50, T55, T60, T70

52605



DESPIECE  
DISPONIBLE

## ESTUCHE PUNTAS 55 PIEZAS HEAVY DUTY

52753

2,96 4 184  
Kg fl

98,00€

S-2 3/8" 1/2" 55 PCS

### CONTIENE

	3/8"	x1	10mm
	1/2"	x2	10, 14mm
	30mm	x9	4, 5, 6, 7, 8, 10, 12, 14, 16mm - ISO 2136
	75mm	x9	4, 5, 6, 7, 8, 10, 12, 14, 16mm - ISO 2136
	30mm	x10	T20, T25, T30, T40, T45, T50, T55, T60, T70, T80 - DIN 2325
	75mm	x10	T20, T25, T30, T40, T45, T50, T55, T60, T70, T80 - DIN 2325
	30mm	x7	M5, M6, M8, M10, M12, M14, M16 - DIN 2325
	75mm	x7	M5, M6, M8, M10, M12, M14, M16 - DIN 2325

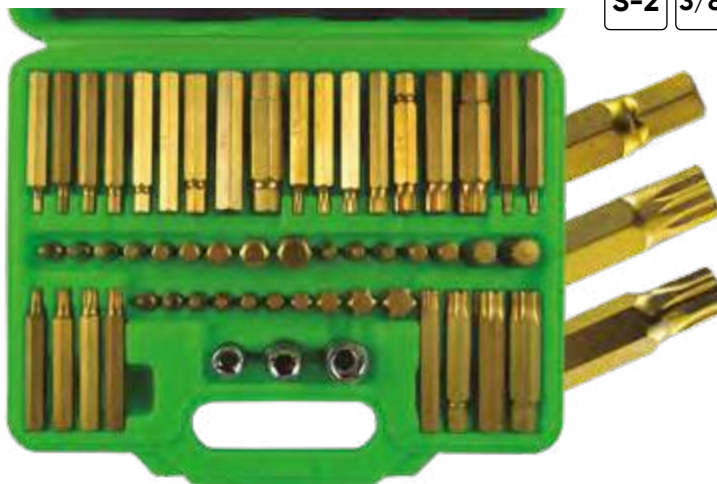

DESPIECE DISPONIBLE

## ESTUCHE DE 42 PIEZAS PARA TORNILLOS DE 12 Y 6 CANTOS TORX

50983

1,77 5 200  
Kg fl

48,00€

50985

1,74 5 240  
Kg fl

59,00€

S-2 3/8" 1/2" 42 PCS



### CONTIENE

	3/8"	x1	10mm
	1/2"	x1	10mm
	30mm	x7	4, 5, 6, 7, 8, 10, 12mm
	75mm	x7	4, 5, 6, 7, 8, 10, 12mm
	30mm	x8	T20, T25, T30, T40, T45, T50, T55, T60
	75mm	x8	T20, T25, T30, T40, T45, T50, T55, T60
	30mm	x5	M5, M6, M8, M10, M12
	75mm	x5	M5, M6, M8, M10, M12
	30mm	x7	4, 5, 6, 7, 8, 10, 12mm
	75mm	x7	4, 5, 6, 7, 8, 10, 12mm
	30mm	x8	T20, T25, T30, T40, T45, T50, T55, T60
	75mm	x8	T20, T25, T30, T40, T45, T50, T55, T60
	30mm	x5	M5, M6, M8, M10, M12
	75mm	x5	M5, M6, M8, M10, M12



50983



DESPIECE DISPONIBLE

50985



DESPIECE DISPONIBLE

## ESTUCHE DE PUNTAS 75 PIEZAS

PARA TORNILLOS RIBE, 12 CANTOS, TORX, TORX INV., HEXAGONAL

52550

3,61 4 72  
Kg fl

89,00€

S-2 3/8" 1/2" 75 PCS

CrV

### CONTIENE

	3/8"	x1	10mm
	1/2"	x2	10mm
	30mm	x7	4, 5, 6, 7, 8, 10, 12mm
	75mm	x7	4, 5, 6, 7, 8, 10, 12mm
	30mm	x8	T20, T25, T30, T40, T45, T50, T55, T60
	75mm	x8	T20, T25, T30, T40, T45, T50, T55, T60
	30mm	x5	M5, M6, M8, M10, M12
	75mm	x5	M5, M6, M8, M10, M12
	30mm	x8	M5, M6, M7, M8, M9, M10, M12, M14
	75mm	x5	M5, M6, M8, M10, M12
	30mm	x8	T20, T25, T30, T40, T45, T50, T55, T60
	75mm	x8	T20, T25, T30, T40, T45, T50, T55, T60



DESPIECE DISPONIBLE



## ESTUCHE DE PUNTAS DE 208 PIEZAS

**53574**  
43,50€

2,29 6 216  
Kg fl

**208**  
PCS  
**CrV**

### CONTIENE

25mmL	x12	1,5, 2, 2,5, 3, 3,5, 4, 4,5, 5, 5,5, 6, 7, 8mm	25mmL	x4	4, 6, 8, 10mm
50mmL	x5	1/16, 5/64, 3/32, 7/64, 1/8, 9/64, 5/32, 3/16, 7/32, 1/4	50mmL	x4	4, 6, 8, 10mm
75mmL	x5	2,5, 3, 4, 5, 6mm	25mmL	x4	1, 2, 3, 4mm
25mmL	x18	PH00, PH0, PH1(x5), PH2(x5), PH3(x5), PH4	50mmL	x4	1, 2, 3, 4mm
50mmL	x3	PH1, PH2, PH3	25mmL	x6	2, 2,5, 3, 4, 5, 6mm
75mmL	x3	PH1, PH2, PH3	25mmL	x6	5/64, 3/32, 7/64, 1/8, 9/64, 5/32
25mmL	x17	PZ00, PZ0, PZ1(x5), PZ2(x5), PZ3(x4), PZ4	25mmL	x13	T5, 6, 7, 8, 9, 10, 15, 20, 25, 27, 30, 40, 45
50mmL	x3	PZ1, PZ2, PZ3	25mmL	x3	1, 2, 3mm
75mmL	x3	PZ1, PZ2, PZ3	25mmL	x4	0, 1, 2, 3mm
25mmL	x14	T5, T6, T7, T8, T9, T10, T15, T20, T25, T27, T30, T35, T40, T45	25mmL	x3	M5, M6, M8
50mmL	x7	T10, T15, T20, T25, T27, T30, T40	25mmL	x9	
75mmL	x7	T10, T15, T20, T25, T27, T30, T40	25mmL	x12	
25mmL	x3	6, 8, 10mm			
50mmL	x3	6, 8, 10mm			



mm	x10	4, 5, 6, 7, 8, 9, 10, 11, 12, 13
"	x10	5/32, 3/16, 7/32, 1/4, 9/32, 5/16, 11/32, 3/8, 7/16, 1/2
6mm	x1	1/4" x1 Adaptador
	x1	

## ESTUCHE DE PUNTAS EN SURTIDO

**52539**  
59,00€

1,90 5 128  
Kg fl

ALLEN 8 **CrV** **85**  
PCS

### CONTIENE

	x2	PH3, PH4
	x2	PZ3, PZ4
8mm	x5	7, 8, 10, 12, 14mm
	x3	SL8, SL10, SL12
	x5	T40, T45, T50, T55, T60



DESPIECE DISPONIBLE

## ESTUCHE DE PUNTAS DESTORNILLADOR EN SURTIDO

**52538**  
62,00€

2,07 16 128  
Kg fl

**CrV** 1/4" **90**  
PCS

### CONTIENE

	x2	PH1, PH2
	x2	PZ1, PZ2
1/4"	x5	3, 4, 5, 6mm
	x3	SL4, SL5.5, SL6.5
	x5	T8, T10, T15, T20, T25, T27, T30



DESPIECE DISPONIBLE

## JUEGO DE 6 ADAPTADORES

**51333**  
18,00€

0,5 5 40 640  
Kg fl

**CrV** **6**  
PCS

### CINCADO



M	F
1/2"	3/4"
3/8"	1/2"
1/4"	3/8"
3/8"	1/4"
1/2"	3/8"
3/4"	1/2"

### DESPIECE DISPONIBLE

REF.	DESCRIPCIÓN	€
11360	1/4H A 3/8M	0,02 2,60€
11361	1/4M - 3/8H	0,05 3,20€
11362	1/2H A 3/4M	0,13 5,20€
11363	3/8H A 1/2M	0,05 3,90€
11364	1/2H A 3/8M	0,05 4,50€
11365	3/4H A 1/2M	0,14 9,40€



## SET DE 6 ADAPTADORES DE IMPACTO

**53743**  
34,00€

0,80 5 20  
Kg fl

**6**  
PCS



M →  
F →

### DESPIECE DISPONIBLE

REF.	mm	€
14749	1/4" F - 3/8" M	- 20 100 2,00€
14750	3/8" M - 1/4" F	- 20 100 2,00€
14751	3/8" M - 1/2" F	- 20 100 4,00€
14752	1/2" F - 3/8" M	- 10 100 4,00€

M	F
3/4"	1/2"
1/2"	3/4"
3/8"	1/4"
1/4"	3/8"
1/2"	3/8"
3/8"	1/2"

# HERRAMIENTAS DE PULGADA

## ESTUCHE DE HERRAMIENTAS DE 35 PIEZAS EN PULGADA

**53076** 4,97 3 108  
72,00€   

 **CrV** **1/2"** **1/4"** **35**  
PCS





**53076**









DESPIECE  
DISPONIBLE

CROMADO



CONTIENE

	<b>1/2"</b> x17	5/16", 3/8", 7/16", 1/2", 9/16", 19/32", 5/8", 11/16", 3/4", 13/16", 7/8", 15/16", 1", 1-1/16", 1-1/8", 1-3/16", 1-1/4"
	<b>1/4"</b> x8	3/16", 7/32", 1/4", 9/32", 5/16", 11/32", 3/8", 7/16"
	<b>53076</b> x2	1/2" - 1/4"

	<b>1/2"</b> x2	5", 10"
	<b>1/4"</b> x1	3"
	x1	1/2"

	x1	1/4"
	x2	1/2" - 1/4"
	x1	1/4"

## SET DE 17 LLAVES COMBINADAS EN PULGADA

**51890** 3,92 4 192  
78,00€   

CINCADO

**52972** 4,60 4  
79,00€  

CROMADO

5/16", 3/8", 7/16", 1/2",  
9/16", 19/32", 5/8", 11/16",  
3/4", 13/16", 7/8", 15/16", 1",  
1-1/16", 1-1/8", 1-3/16", 1-1/4"

**17**  
PCS

**CrV**



52972

51890



## SET DE LLAVES ALLEN EN PULGADA

**54005** 0,37 10 40 1.120  
14,00€    **9**  
PCS

 **CrV**

1/16", 5/64", 3/32", 1/8", 5/32",  
3/16", 1/4", 5/16", 3/8"

↑ 72-170mm

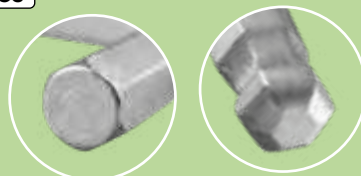



## ESTUCHE DE 38 PIEZAS CON CARRACA MINI DE 1/4"

**53156**

0,48 6 36 1.008

22,50€



**52198**

0,45 6 36 1.800

33,00€



CrV

1/4"

38  
PCS

53156



52198



### CONTIENE

	1/4"	x11	4, 4.5, 5, 6, 7, 8, 9, 10, 11, 12, 13mm
	72	x1	1/4"
		x2	PH3, PH4
		x2	PZ3, PZ4
		x5	4, 5, 6, 7, 8mm
	6mm	x3	SL6, SL8, SL10
		x2	T8, T9, T10, T15, T20, T25, T30, T40
		x4	M5, M6, M9, M10
		x1	1/4"

## JUEGO DE VASOS DE 1/2"

**52714**

0,65 4 24 576

15,50€



**52716**

0,60 4 24 576

15,50€



10, 11, 12, 13, 14, 15, 16, 17, 18, 19mm

1/2"

10  
PCS

PRESENTADAS EN GUÍA METÁLICA



CrV



DESPIECE DISPONIBLE



DESPIECE DISPONIBLE

## JUEGO DE VASOS DE 1/4"

**52715**

0,27 6 36 1.152

10,00€



**52717**

0,27 6 36 1.152

11,00€



4, 4.5, 5, 5.5, 6, 7, 8, 9, 10, 11, 12, 13, 14mm

1/4"

13  
PCS

CrV

PRESENTADAS EN GUÍA METÁLICA



DESPIECE DISPONIBLE



DESPIECE DISPONIBLE

## JUEGO DE PUNTAS 1/4", 18 PCS

**52909**

0,35 8 32 1.500

12,50€



S-2 1/4"

18  
PCS



CrV



PRESENTADAS EN GUÍA METÁLICA

## JUEGO DE PUNTAS 1/4", 30 PCS

**52908**

0,60 8 32 500

17,50€



S-2 1/4"

30  
PCS



CrV



PRESENTADAS EN GUÍA METÁLICA

### CONTIENE

	x2	PH1, PH2
	x2	PZ1, PZ2
	x4	3, 4, 5, 6mm
	x3	SL4, SL5.5, SL6.5
	x7	T8, T10, T15, T20, T25, T27, T30

### CONTIENE

	x3	PH0, PH1, PH2
	x3	PZ0, PZ1, PZ2
	x4	3, 4, 5, 6mm
	x4	SL4, SL5.5, SL6.5, SL7
	x8	T8, T9, T10, T15, T20, T25, T27, T30
	x8	T8, T9, T10, T15, T20, T25, T27, T30

## JUEGO DE 7 PUNTAS TORX DE 3/8" Y 1/2"

**53084**  
24,00€

0,70 5 20



3/8": T30, T40, T45, T50  
1/2": T55, T60, T70



1/2" 3/8" 7 PCS



PRESENTADAS EN GUÍA METÁLICA

## JUEGO DE 7 PUNTAS TORX INVIOLEABLE 1/4"

**53127**  
12,00€

0,10 100 1.000



T10, T15, T20, T25, T30, T40, T45



CrV 1/4" 7 PCS



PRESENTADAS EN GUÍA METÁLICA



## JUEGO DE PUNTAS TS 5 CARAS INVIOLEABLE

**51746**  
12,00€

0,2 5 75



TS10, TS15, TS20, TS25, TS30, TS40, TS45



CrV 1/4" 7 PCS

PRESENTADAS EN GUÍA METÁLICA



## JUEGO DE PUNTAS

**50980**  
22,00€

0,76 5 20 300



CrV 1/2" 3/8" 7 PCS

**50982**  
22,00€

0,46 10 40 300



PRESENTADAS EN GUÍA METÁLICA



**52320**  
22,00€

0,76 5 20 480



**50980** 1/2" 3/8" 1/2" 100mm: M12, M13, M14  
3/8" 90mm: M6, M7, M8, M10



**50982** 3/8" 3/8" 100mm HB3: 4, 5, 6, 7, 8, 10mm



**52320** 1/2" 3/8" 1/2" 100mm: M12, M13, M14  
3/8" 90mm: M6, M7, M8, M10



## VASOS PUNTA XZN ESP. VAG

**12029**  
4,50€

0,17 5 50 1.500



INVIOLEABLE M16X58MM



**12030**  
6,50€

0,25 25 50 1.500



INVIOLEABLE M16X100MM



## PUNTA EXTRALARGA DE 12 CANTOS 800MM DE 1/2"

REF.	DESCRIPCIÓN					€
52059	Ø 8mm - 800mm	0,58	10	20	1.750	29,00€
52060	Ø 10mm - 800mm	0,58	-	25	1.750	32,00€
53667	Ø 12mm - 800mm	0,80	10	20	-	32,00€
53668	Ø 14mm - 800mm	1,05	10	20	-	34,00€

800mm CrV 1/2"





## SET DE LLAVES FIJAS AISLADAS

53152

373,00€

4,70

3

72



CrV

20  
PCS

6, 7, 8, 9, 10, 11, 12, 13,  
14, 15, 16, 17, 18, 19, 21,  
22, 24, 27, 30, 32mm



## ESTUCHE DE HERRAMIENTAS AISLADAS

53154

462,00€

3,3

3

72



CrV

3/8"

20  
PCS

### CONTIENE

	3/8"	x12	8, 10, 11, 12, 13, 14, 16, 17, 18, 19, 21, 22mm
	1/2"	x1	200mm
	1/2"	x2	125, 250mm
	3/8"	x1	200mm
	3/8"	x4	4, 5, 6, 8mm



## SET DE 50 DESTORNILLADORES AISLADOS

52521

125,00€

1,43

6

240



CrV

50  
PCS



### CONTIENE

	x3	PH0, PH1, PH2		x5	H2.5, H3, H4, H5, H6		x3	M4x4.0, M5x5.0, M6x5.0		x1	89
	x7	SLO.4x2.0, SLO.4x2.5, SLO.5x3.0, SLO.6x3.5, SLO.8x4.0, SL1.0x5.5, SL1.2x6.5mm		x2	R1, R2		x4	4, 6, 8, 10mm		x1	89
	x3	PZ0, PZ1, PZ2		x4	1, 2, 3, 4		x2	R1, R2		Voltage Tester: 3.0 x 70 + Torx 31 x 105	
	x9	T6, T8, T9, T10, T15, T20, T25, T27, T30		x4	4, 6, 8, 10		x2	6.3 x 89, 8.1 x 89			



# CONJUNTO DE PUNTAS Y DESTORNILLADOR ELÉCTRICAMENTE AISLADOS HASTA 1.000V

**52009**  
36,00€

0,34 10 50  
Kg u.s. fl

- Optimizado para aplicaciones en trabajo con electricidad.  
- Herramienta de seguridad.

CrV

## CONTIENE

x2 PH1x100, PH2x100  
x4 SL0.4x2.5x100, SL0.8x4.0x100, SL1.0x5.5x100, SL1.2x6.5x100mm



AC 1000V  
IEC 60900:2004

Cumple con: DIN EN60900:2005-01 - EN60900:2004

# SET DE DESTORNILLADORES AISLADOS 1.000V

**52519**  
25,50€

0,14 5 30 840  
Kg u.s. fl

CrV

## CONTIENE

x2 PH00x50, PH0x50mm  
x5 SL1.5x0.23x50, SL1.8x0.30x50, SL2.0x0.40x50, SL2.5x0.40x50, SL3.0x0.50x50mm



AC 1000V  
IEC 60900:2004

# DESTORNILLADORES CON MÓDULO EVA CARBONO

**15162**  
25,50€

0,50 10 220  
Kg u.s. fl

x4 0.5x3.0x75, 0.8x4.0x100, 1.0x5.5x125, 1.2x6.5x150mm  
x3 PH0x75, PH1x80, PH2x100mm

VDE

8  
PCS

## DESPIECE DISPONIBLE

REF.	Ø				€
15227	0.5x3.0x75mm	0,02	10	50	3,50€
15228	0.8x4.0x100mm	0,05	10	50	4,00€
15229	1.0x5.5x125mm	0,08	5	50	5,00€
15230	1.2x6.5x150mm	0,11	5	50	5,00€
15231	PH0x75mm	0,02	10	50	3,50€
15232	PH1x80mm	0,05	10	50	4,00€
15233	PH2x100mm	0,08	5	50	5,00€
15234	Comprobador de corriente 140mm	0,02	10	50	3,00€

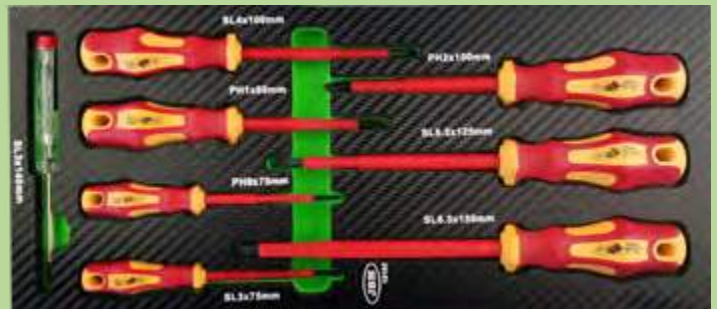

# CUCHILLO AISLADO

## RECTO

**53164**  
15,00€

0,10 6 36  
Kg u.s. fl

## CURVADO

**53165**  
17,50€

0,10 6 36  
Kg u.s. fl

180mm

50mm

CrV

1000V  
IEC 60900

Certificate  
EN60900





LLAVES 36



LLAVES EN PULGADA 43



DESTORNILLADORES 44



MEDICIÓN 46



CANDADOS 47



MARTILLOS 48



SIERRAS 49



CINCELES 50



REMACHADORAS 51



CARRACAS 52



BARRAS DE EXTENSIÓN 56



CORTATUBOS 58



PELACABLES 59



ALICATES 60



LLAVES DE GANCHO / ROMPETUERCAS / INGLESA 65

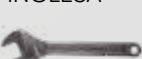

LLAVES STILLSON 66



MORDAZAS 66



CORTAVARILLAS 66



# HERRAMIENTAS MANUALES



**SERIE261**

# SET DE LLAVES COMBINADAS ARTICULADAS CON TRINQUETE



- Cabezal articulado de 0° a 180°.  
- Chicharra de 72 dientes con 5° de arco.

CROMADO



12 LLAVES

7 LLAVES

**51318**  
89,00€

8, 9, 10, 11, 12, 13, 14, 15, 16, 17, 18, 19mm

12  
PCS

Kg 2,15  
5  
10  
200



**53017**  
52,00€

8, 10, 11, 13, 14, 17, 19mm

7  
PCS

Kg 1,18  
5  
10  
320



DESPIECE DISPONIBLE

REF.	mm	kg	5	10	€
10552	8mm	0,06	10	7,10€	
10553	9mm	0,07	10	7,35€	
10554	10mm	0,09	10	7,50€	

REF.	mm	kg	5	10	€
10555	11mm	0,09	10	7,80€	
10556	12mm	0,11	10	8,10€	
10557	13mm	0,13	10	8,10€	

REF.	mm	kg	5	10	€
10558	14mm	0,15	10	9,35€	
10559	15mm	0,16	10	9,50€	
10560	16mm	0,19	10	10,60€	

REF.	mm	kg	5	10	€
10561	17mm	0,22	10	10,95€	
10562	18mm	0,26	5	12,30€	
10563	19mm	0,28	10	12,45€	

## SET 6 LLAVES CON TRINQUETE

**53021**  
44,00€

0,86 5 20 1.500

8x9, 10x11, 12x13, 14x15, 16x18, 17x19mm

CROMADO



6  
PCS



DESPIECE DISPONIBLE

REF.	mm	kg	5	10	€
13485	8x9mm	0,06	10	7,60€	
13486	10x11mm	0,09	10	8,35€	
13487	12x13mm	0,12	10	9,40€	
13488	14x15mm	0,15	10	11,05€	
13489	16x18mm	0,2	10	12,65€	
13490	17x19mm	0,25	10	13,60€	



## SET 7 LLAVES CON TRINQUETE EXTRALARGAS

**54066**  
78,50€

2,33 5 175

**53019**  
78,00€

2,33 5 175

CROMADO



7  
PCS

MÓDULO ACABADO EN FIBRA DE CARBONO

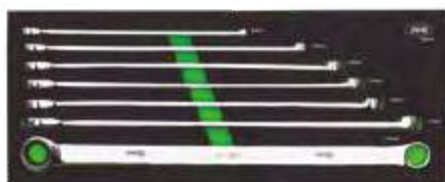

DESPIECE DISPONIBLE



REF.	mm	kg	5	10	€
13453	8mm	0,1	6	9,00€	
13454	10mm	0,15	6	9,50€	
13455	12mm	0,21	6	10,50€	
13456	13mm	0,23	6	11,50€	
13457	14mm	0,28	6	12,00€	
13460	17mm	0,44	6	15,00€	
13462	19mm	0,53	6	17,00€	

8mm (23,5mmL)  
10mm (29,3mmL)  
12mm (32,8mmL)  
13mm (34,9mmL)  
14mm (36,7mmL)  
17mm (41mmL)  
19mm (42mmL)

## SET 8 LLAVES COMBINADAS CORTAS CON TRINQUETE

**53022**  
46,00€

0,82 5 20 1.500

CROMADO



8  
PCS



DESPIECE DISPONIBLE



REF.	mm	kg	5	10	€
13491	10mm	0,05	10	5,30€	
13492	11mm	0,06	10	5,35€	
13493	12mm	0,07	10	5,50€	
13494	13mm	0,08	10	6,00€	
13495	14mm	0,09	10	6,40€	
13496	15mm	0,12	10	6,60€	
13497	17mm	0,14	10	7,50€	
13498	19mm	0,19	10	8,50€	

10, 11, 12, 13, 14, 15, 17, 19mm



## SET DE 22 LLAVES COMBINADAS CON TRINQUETE

54041

8,5

2

198,00€



6, 7, 8, 9, 10, 11, 12, 13, 14, 15, 16, 17, 18, 19, 20, 21, 22, 23, 24, 27, 30, 32mm

### DESPIECE DISPONIBLE

REF.	mm	g	l	€	REF.	mm	g	l	€
15352	6mm	0,03	10	6,00€	15363	17mm	0,19	10	9,00€
15353	7mm	0,04	10	6,00€	15364	18mm	0,22	10	9,00€
15354	8mm	0,05	10	6,00€	15365	19mm	0,22	10	10,00€
15355	9mm	0,06	10	6,00€	15366	20mm	0,23	10	10,50€
15356	10mm	0,1	10	6,00€	15367	21mm	0,37	10	11,50€
15357	11mm	0,08	10	6,50€	15368	22mm	0,37	10	12,50€
15358	12mm	0,09	10	6,50€	15369	23mm	0,37	10	13,00€
15359	13mm	0,1	10	7,00€	15370	24mm	0,53	10	13,50€
15360	14mm	0,11	10	7,50€	15371	27mm	0,74	10	20,00€
15361	15mm	0,13	10	8,00€	15372	30mm	0,89	10	23,00€
15362	16mm	0,15	10	8,50€	15373	32mm	1,12	10	29,00€



22 PCS



90

## SET DE 12 LLAVES MINI COMBINADAS ARTICULADAS CON TRINQUETE

54032

1,33

5

20

79,00€



8, 9, 10, 11, 12, 13, 14, 15, 16, 17, 18, 19mm

### DESPIECE DISPONIBLE

REF.	mm	g	l	€	REF.	mm	g	l	€
15328	8mm	0,11	6	6,00€	15334	14mm	0,11	6	7,00€
15329	9mm	0,17	6	5,50€	15335	15mm	0,17	6	7,50€
15330	10mm	0,22	6	5,50€	15336	16mm	0,22	6	8,00€
15331	11mm	0,31	6	5,50€	15337	17mm	0,31	6	8,50€
15332	12mm	0,45	6	6,00€	15338	18mm	0,45	6	9,00€
15333	13mm	0,47	6	6,50€	15339	19mm	0,47	6	9,50€



12 PCS

## SET DE 22 LLAVES COMBINADAS CON TRINQUETE

53020

7,38

2

54

199,00€



22 PCS

6, 7, 8, 9, 10, 11, 12, 13, 14, 15, 16, 17, 18, 19, 20, 21, 22, 23, 24, 27, 30, 32mm



CROMADO



## SET DE 12 LLAVES COMBINADAS CON TRINQUETE

53871

1,60

2

6

288

59,90€



12 PCS

8, 9, 10, 11, 12, 13, 14, 15, 16, 17, 18, 19mm



CROMADO



### DESPIECE DISPONIBLE REF.53020,53871,15122

REF.	mm	g	l	€	REF.	mm	g	l	€
13463	6mm	0,03	10	5,30€	13474	17mm	0,19	10	8,70€
13464	7mm	0,04	10	5,30€	13475	18mm	0,22	10	9,10€
13465	8mm	0,05	10	5,55€	13476	19mm	0,22	10	9,60€
13466	9mm	0,06	10	5,55€	13477	20mm	0,23	10	9,85€
13467	10mm	0,1	10	6,00€	13478	21mm	0,37	10	12,20€
13468	11mm	0,08	10	6,25€	13479	22mm	0,37	10	13,10€
13469	12mm	0,09	10	6,25€	13480	23mm	0,37	10	15,45€
13470	13mm	0,1	10	6,60€	13481	24mm	0,53	10	15,75€
13471	14mm	0,11	10	6,90€	13482	27mm	0,74	10	22,10€
13472	15mm	0,13	10	7,25€	13483	30mm	0,89	10	25,45€
13473	16mm	0,15	10	8,10€	13484	32mm	1,12	10	27,15€

## MÓDULO EVA CARBONO DE 12 LLAVES COMBINADAS CON TRINQUETE

15122

1,70

10

220

69,00€



12 PCS

8, 9, 10, 11, 12, 13, 14, 15, 16, 17, 18, 19mm

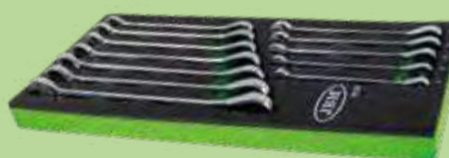

CROMADO



## SET 6 LLAVES ARTICULADAS CON TRINQUETE

53018

2,66 5 125  
Kg fl

136,00€



CROMADO



6  
PCS

8x9,10x11, 12x13,  
14x15, 16x18,  
17x19mm

DESPIECE DISPONIBLE

REF.	mm			€
13447	8x9mm	0,11	6	16,50€
13448	10x11mm	0,17	6	17,50€
13449	12x13mm	0,22	6	20,00€
13450	14x15mm	0,31	6	23,00€
13451	16x18mm	0,45	6	28,00€
13452	17x19mm	0,47	6	29,50€



## MÓDULO EVA FIBRA DE CARBONO DE 7 LLAVES COMBINADAS ARTICULADAS CON TRINQUETE

15158

1,05 10 220  
Kg fl

50,00€

CROMADO



8, 10, 11, 13,  
14, 17, 19mm



7  
PCS

DESPIECE DISPONIBLE

REF.	mm			€
15216	8mm	0,05	10	6,75€
15217	10mm	0,08	10	7,20€
15218	11mm	0,08	10	7,65€
15219	13mm	0,11	10	8,10€
15220	14mm	0,15	10	9,05€
15221	17mm	0,21	10	10,85€
15222	19mm	0,26	10	11,75€



## MÓDULO DE 3 LLAVES 4 EN 1

15316

0,73 10 220  
Kg fl

50,00€



8-9-10-11-12-13-  
14-15-16-17-18-  
19mm

3  
PCS

DESPIECE DISPONIBLE

REF.	mm		€
15515	12-13mm x 8-10mm	0,13	15,50€
15516	14-15mm x 9-11mm	0,18	19,00€
15517	18-19mm x 16-17mm	0,37	22,50€

CROMADO



## SET DE 4 LLAVES TORX ARTICULADAS CON TRINQUETE

50754

0,82 20 360  
Kg fl

59,00€

CROMADO

E6 x E8  
E10 x E12  
E14 x E18  
E20 x E24



- Cabezal articulado de 0° a 180°.  
- Chicharra de 72 dientes con 5° de Arco.



4  
PCS

DESPIECE DISPONIBLE

REF.			€
10527	E6xE8	0,09	13,05€
10528	E10xE12	0,12	15,80€
10529	E14xE18	0,22	18,00€
10530	E20xE24	0,37	28,65€



## ESTUCHE CON 6 LLAVES DE VASO 12 CANTOS ARTICULADAS

51659

1,60 10 230  
Kg fl

59,00€

CROMADO



6  
PCS

8x9, 10x11, 12x13,  
14x15, 16x17,  
18x19mm



DESPIECE DISPONIBLE

REF.	Ø		€
10621	XZN 8-9	0,09	9,50€
10622	XZN 10-11	0,13	10,00€
10623	XZN 12-13	0,16	12,60€
10624	XZN 14-15	0,20	13,50€
10625	XZN 16-17	0,29	15,65€
10626	XZN 18-19	0,37	17,75€



## ESTUCHE CON 4 LLAVES DE VASO ARTICULADAS TORX

50622

1,07 10 320  
Kg fl

48,50€

CROMADO



4  
PCS

E6xE8, E10xE12,  
E14xE18, E20xE24

DESPIECE DISPONIBLE

REF.	Ø		€
10617	E6xE8	0,07	14,05€
10618	E10xE12	0,11	15,10€
10619	E14xE18	0,20	15,65€
10620	E20xE24	0,34	16,15€





## MÓDULO EVA FIBRA DE CARBONO DE 6 LLAVES FIJAS TIPO "S"

15160

39,00€

0,73 10 220

8x9, 10x11, 12x13, 14x15, 16x17, 18x19mm

6 PCS

CROMADO



DESPIECE DISPONIBLE

REF.	mm	Kg	Paq	Paq	Paq	€
15196	8x9mm	0,04	10	50	5,00€	
15197	10x11mm	0,06	10	50	5,50€	
15198	12x13mm	0,09	10	50	6,50€	
15199	14x15mm	0,13	10	50	7,50€	
15200	16x17mm	0,16	5	50	9,50€	
15201	18x19mm	0,18	5	50	9,50€	



## MÓDULO EVA FIBRA DE CARBONO DE 4 LLAVES COMBINADAS

15161

56,00€

1,55 10 220

27, 29, 30, 32mm

4 PCS

CROMADO

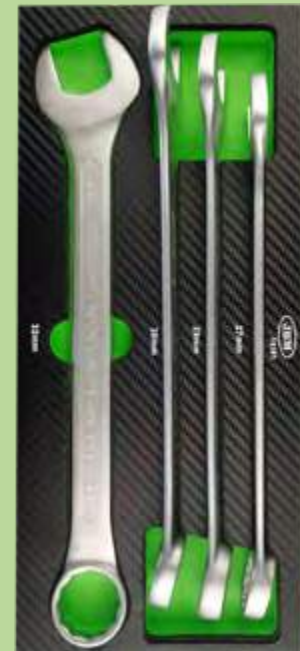

DESPIECE DISPONIBLE

REF.	mm	Kg	Paq	Paq	Paq	€
15223	27mm	0,36	5	50	14,00€	
15224	29mm	0,42	5	50	15,00€	
15225	30mm	0,47	5	50	15,50€	
15226	32mm	0,57	5	50	17,50€	



## KIT DE 8 LLAVES COMBINADAS CORTAS

50564

30,00€

0,65 5 20 400

8 PCS

10, 11, 12, 13, 14, 15, 17, 19mm

CROMADO

DESPIECE DISPONIBLE

REF.	mm	Kg	Paq	Paq	Paq	€
10564	10	0,05	10	100	2,50€	
10565	11	0,05	10	100	3,50€	
10566	12	0,05	10	100	3,50€	
10567	13	0,05	10	100	3,50€	
10568	14	0,06	10	100	4,00€	
10569	15	0,05	10	100	4,50€	
10570	16	0,10	10	100	4,50€	
10571	17	0,15	10	100	5,00€	



## LLAVES COMBINADAS

14 LLAVES

50560

35,00€

52970

37,00€



14 PCS



6, 7, 8, 9, 10, 11, 12, 13, 14, 15, 16, 17, 18, 19mm

CINCADO

CROMADO

Kg	1,25	Kg	1,30
Paq	5	Paq	5
Paq	20	Paq	20
Paq	240	Paq	384



DESPIECE DISPONIBLE

CINCADO	mm	Kg	Paq	Paq	Paq	€
10548	6mm	0,03	10	100	1,75€	
10549	7mm	0,03	10	100	2,00€	
10550	8mm	0,04	10	100	2,15€	
10551	9mm	0,05	10	100	2,15€	
10531	10mm	0,05	10	100	3,00€	
10532	11mm	0,05	10	100	2,70€	
10533	12mm	0,07	10	100	3,00€	
10534	13mm	0,08	10	100	3,25€	
10535	14mm	0,10	10	100	3,50€	
10536	15mm	0,10	10	100	3,65€	

50560



CINCADO	mm	Kg	Paq	Paq	Paq	€
10537	16mm	0,11	10	100	3,90€	
10538	17mm	0,14	10	100	4,30€	
10539	18mm	0,16	10	100	4,75€	
10540	19mm	0,20	10	60	5,25€	

7 LLAVES

7 PCS



20, 21, 22, 24, 27, 30, 32mm

CINCADO

50896

47,50€

3 5 10 216

CROMADO

52971

52,50€

2,55 10 224



DESPIECE DISPONIBLE

CINCADO	mm	Kg	Paq	Paq	Paq	€
10541	20mm	0,03	6	60	5,55€	
10542	21mm	0,03	6	60	5,85€	
10543	22mm	0,04	6	60	7,00€	
10544	24mm	0,05	6	48	8,10€	
10545	27mm	0,05	6	24	9,75€	
10546	30mm	0,05	6	24	11,55€	
10547	32mm	0,07	6	24	13,45€	

50896



# LLAVES FIJAS

12 LLAVES

7 LLAVES

**12 PCS**  
6x7, 8x9, 10x11, 12x13, 14x15, 16x17, 18x19, 20x22, 21x23, 24x27, 25x28, 30x32mm

**7 PCS**  
6x7, 8x9, 10x11, 12x13, 14x15, 16x17, 18x19mm

**51529**  
53,00€

**52973**  
57,00€

**50561**  
18,00€

**52974**  
16,00€

**2,63** **2,50**  
**5** **5**  
**165** **192**  
CINCADO CROMADO

**0,69** **0,7**  
**5** **5**  
**20** **20**  
**320** **440**  
CINCADO CROMADO



DESPIECE DISPONIBLE

CINCADO	mm	Kg	US	fl	€	CINCADO	mm	Kg	US	fl	€	CINCADO	mm	Kg	US	fl	€	CINCADO	mm	Kg	US	fl	€
10589	6x7	0,03	10	100	2,00€	10580	12x13	0,07	10	100	3,10€	10583	18x19	0,19	10	100	4,15 €	10586	24x27	0,35	-	50	7,60 €
10590	8x9	0,03	10	100	2,40€	10581	14x15	0,10	10	100	3,40€	10584	20x22	0,25	-	100	5,05 €	10587	25x28	0,36	-	50	9,80 €
10579	10x11	0,06	5	100	3,00€	10582	16x17	0,14	10	100	4,00€	10585	21x23	0,31	-	50	6,75 €	10588	30x32	0,54	-	25	10,50 €

# LLAVES ESTRELLA ACODADAS 12 CANTOS

12 LLAVES

7 LLAVES

**12 PCS**  
6x7, 8x9, 10x11, 12x13, 14x15, 16x17, 18x19, 20x22, 21x23, 24x27, 25x28, 30x32mm

**7 PCS**  
6x7, 8x9, 10x11, 12x13, 14x15, 16x17, 18x19mm

**50889** 3,66 5 20 280  
64,50€

**52975** 3,55 1 4 200  
66,50€

**50562**  
20,00€

**52976**  
22,00€

**0,87** **5** **20** **500**  
**1,2** **2** **12** **288**  
Kg US fl



DESPIECE DISPONIBLE

CINCADO	mm	Kg	US	fl	€	CINCADO	mm	Kg	US	fl	€	CINCADO	mm	Kg	US	fl	€	CINCADO	mm	Kg	US	fl	€
10627	6x7	0,04	10	100	2,80€	10630	12x13	0,11	10	100	3,90€	10633	18x19	0,22	10	100	6,60€	10636	24x27	0,35	-	25	8,80€
10628	8x9	0,06	10	100	3,10€	10631	14x15	0,14	10	100	4,20€	10634	20x22	0,43	-	50	7,80€	10637	25x28	0,48	-	25	12,05€
10629	10x11	0,08	10	100	3,65€	10632	16x17	0,18	10	100	5,30€	10635	21x23	0,30	-	50	8,15€	10638	30x32	0,73	-	-	12,65€

# MÓDULO EVA FIBRA DE CARBONO DE 4 LLAVES ACODADAS

**15156** 1,82 10  
58,00€



**4 PCS**  
21x23, 24x27, 25x28, 30x32mm  
CROMADO

DESPIECE DISPONIBLE

REF.	mm	Kg	US	fl	€
15206	21x23	0,36	5	50	15,00€
15207	24x27	0,38	5	50	16,50€
15208	25x28	0,43	5	50	17,00€
15209	30x32	0,58	10	50	18,00€





## SET DE 8 LLAVES TIPO "C" CABEZAL REDONDO 12 CANTOS

52451

0,93 5 20 300

38,50€



CROMADO



6x7, 8x9, 10x11, 12x13,  
14x15, 16x17, 18x19,  
20x22mm



DESPIECE DISPONIBLE

REF.	mm	Kg	mm	mm	mm	€
11646	20x22	0,22	-	-	-	9,45€
11645	18x19	0,15	-	-	-	7,00€
11644	16x17	0,10	10	100	-	7,00€
11643	14x15	0,09	-	-	-	6,00€
11642	12x13	0,06	10	100	-	5,00€
11641	10x11	0,04	-	-	-	5,00€
11640	8x9	0,04	-	-	-	4,50€
11639	6x7	0,01	10	100	-	4,00€

## JUEGO DE 4 LLAVES TORX PLANAS EN BOLSA DE TELA

51747

21,00€



6x8, 10x12,  
14x18, 20x24mm

CROMADO



## MÓDULO EVA FIBRA DE CARBONO DE 5 LLAVES TIPO "C"

15159

39,00€

0,69 10 220



5  
PCS

8x10, 11x13, 14x15,  
17x19, 20x22mm

CROMADO

DESPIECE DISPONIBLE

REF.	mm	Kg	mm	mm	mm	€
15191	8x10	0,05	10	50	-	7,00€
15192	11x13	0,07	10	50	-	8,00€
15193	14x15	0,10	-	-	-	8,50€
15194	17x19	0,15	5	50	-	10,50€
15195	20x22	0,23	-	-	-	12,50€



## KIT DE LLAVES ESTRELLA PLANA DE 12 CANTOS

51878

48,00€

1 5 10 240



8  
PCS

## KIT LLAVE HEX, CON BOCA ABIERTA DE 6 CANTOS

51879

38,50€

0,74 5 20 480



8  
PCS

CINCADO

10x11, 12x13, 14x15,  
16x17, 18x19

CINCADO

6x7, 8x9, 10x11, 12x13, 14x15,  
16x17, 18x19, 20x22mm

DESPIECE DISPONIBLE

REF.	Ø	Kg	€
11250	XZN 6x7	0,04	5,50€
11251	XZN 8x9	0,04	7,90€
11252	XZN 10x11	0,07	9,00€
11253	XZN 12x13	0,07	9,50€
11254	XZN 14x15	0,09	9,45€
11255	XZN 16x17	0,12	10,85€
11256	XZN 18x19	0,16	11,80€
11257	XZN 20x22	0,23	13,25€



DESPIECE DISPONIBLE

REF.	Ø	Kg	€
11258	HEX 10x11	0,08	7,30€
11259	HEX 12x13	0,11	8,30€
11260	HEX 14x15	0,11	9,75€
11261	HEX 16x17	0,18	11,35€
11262	HEX 18x19	0,21	13,50€



## MÓDULO EVA FIBRA DE CARBONO DE 6 LLAVES DE TUERCA ABOCINADA

15157

42,00€

0,81 10 220



DESPIECE DISPONIBLE

REF.	mm	Kg	mm	mm	mm	€
15210	6x8	0,05	10	50	-	5,00€
15211	10x12	0,07	10	50	-	5,50€
15212	13x14	0,09	10	50	-	6,50€
15213	15x17	0,13	10	50	-	7,00€
15214	19x21	0,16	5	50	-	9,00€
15215	22x24	0,23	5	50	-	10,50€



6  
PCS

6x8, 10x12, 13x14,  
15x17, 19x21,  
22x24mm

CROMADO

## KITS DE 6 LLAVES EXTRALARGAS

**51864**

64,00€

1,87 10 250



10x11mm (290mmL),  
12x14mm (330mmL),  
13x15mm (368mmL),  
16x18mm (407mmL),  
17x19mm (407mmL),  
22x24mm (430mmL)



**52912**

78,50€

1,62

10

220

E6xE7 (200mmL),  
E8xE10 (235mmL),  
E11xE12 (290mmL),  
E14xE16 (370mmL),  
E18xE20 (410mmL),  
E22xE24 (420mmL)



**6**  
PCS

CROMADO

### DESPIECE DISPONIBLE

REF.	Ø		€
11244	XL XZN 10x11	0,13 5	8,50€
11245	XL XZN 12x14	0,18 -	9,15€
11246	XL XZN 13x15	0,21 5	12,35€
11247	XL XZN 16x18	0,30 -	14,00€
11248	XL XZN 17x19	0,31 5	14,55€
11249	XL XZN 22x24	0,43 5	26,50€



## KIT 14 LLAVES PIPA DE DOBLE BOCA

**51528**

43,00€

3,55 5 280



CINCADO

8, 9, 10, 11, 12, 13, 14, 15,  
16, 17, 18, 19, 20, 21mm



**14**  
PCS



### DESPIECE DISPONIBLE

REF.	mm		€
10603	8	0,07	2,10€
10604	9	0,08	2,25€
10591	10	0,09	2,50€
10592	11	0,12	2,55€
10593	12	0,16	3,15€
10594	13	0,17	3,20€
10595	14	0,20	3,35€
10596	15	0,25	4,25€
10597	16	0,30	4,50€
REF.	mm		€
10598	17	0,32	4,60€
10599	18	0,43	6,00€
10600	19	0,41	6,25€
10601	20	0,45	6,50€
10602	21	0,47	7,05€



## MÓDULO EVA FIBRA DE CARBONO DE 11 LLAVES DE TUBO TIPO "L"

**15155**

56,00€

2,03 10 220



**11**  
PCS

8, 10, 11, 12, 13, 14,  
15, 16, 17, 18, 19mm

### DESPIECE DISPONIBLE

REF.	mm		€
15006	8	0,05 10 50	3,50€
15020	9	0,09 10 50	4,00€
15182	10	0,12 10 50	4,50€
15183	11	0,12 10 50	5,00€
15184	12	0,16 10 50	5,50€
15185	13	0,19 5 50	6,00€
REF.	mm		€
15186	17	0,21 5 50	6,50€
15187	18	0,24 5 50	6,50€
15188	19	0,26 5 50	7,00€
15189	20	0,28 5 50	8,50€
15190	21	0,31 5 50	9,00€



## SET DE 8 LLAVES DE TUBO

**53420**

68,00€

1,50 20 540



6x7, 8x9, 10x11, 12x13, 14x15,  
16x17, 18x19, 20x22mm

**8**  
PCS

CINCADO





## SET DE 8 LLAVES TORX EN FORMA DE "T"

**53979**

0,99 10  
Kg fl

30,50€



T10x75,  
T15x75,  
T20x100,  
T25x100,  
T30x150,  
T40x150,  
T45x200,  
T50x200mm



## SET DE 8 LLAVES ALLEN EN FORMA DE "T"

**53980**

1,06 10  
Kg fl

30,50€



H2x100,  
H2.5x100,  
H3x100,  
H4x150,  
H5x150,  
H6x200,  
H8x200,  
H10x200



## SET DE 9 LLAVES TORX

### EXTRALARGAS

**53737**

0,42 10 40  
Kg fl

12,50€

90-218mm



**9**  
PCS

T10, T15, T20,  
T25, T27, T30,  
T40, T45, T50



### LARGAS

**53739**

0,32 10 40  
Kg fl

10,50€

86-150mm

### CORTAS

**53955**

0,25 10 40 1.480  
Kg fl

10,00€

72-170mm



## SET DE 9 LLAVES ALLEN

### EXTRALARGAS

**53738**

0,45 10 40  
Kg fl

11,50€

90-220mm



**9**  
PCS

2, 2.5, 3, 4, 5,  
5.5, 6, 8, 10mm



### LARGAS

**53740**

0,37 10 40  
Kg fl

10,00€

72-170mm

### CORTAS

**53954**

0,25 10 40 1.480  
Kg fl

9,50€

43-97mm

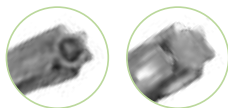

53955

53737

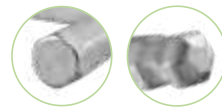

53954

53738

## HERRAMIENTAS DE PULGADA

### SET DE 17 LLAVES COMBINADAS EN PULGADA

**51890**

3,92 4 192  
Kg fl

78,00€

CINCADO

**52972**

4,60 4  
Kg fl

79,00€

CROMADO

**17**  
PCS

5/16", 3/8", 7/16", 1/2", 9/16",  
19/32", 5/8", 11/16", 3/4", 13/16",  
7/8", 15/16", 1", 1-1/16", 1-1/8",  
1-3/16", 1-1/4"



### SET DE 9 LLAVES ALLEN EN PULGADA

**54005**

0,37 10 40 1.120  
Kg fl

14,00€

**9**  
PCS

CrV

1/16", 5/64", 3/32", 1/8",  
5/32", 3/16", 1/4", 5/16",  
3/8"

72-170mm

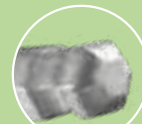

## ESTUCHE DE PUNTAS DE 208 PIEZAS

53574

2,29 6 216

43,50€



208  
PCS

CrV

### CONTIENE

25mmL	x12	1,5, 2, 2,5, 3, 3,5, 4, 4,5, 5, 5,5, 6, 7, 8mm	25mmL	x4	4, 6, 8, 10mm
50mmL	x10	1/16, 5/64, 3/32, 7/64, 1/8, 9/64, 5/32, 3/16, 7/32, 1/4	50mmL	x4	4, 6, 8, 10mm
75mmL	x5	2,5, 3, 4, 5, 6mm	25mmL	x4	1, 2, 3, 4mm
25mmL	x5	2,5, 3, 4, 5, 6mm	50mmL	x4	1, 2, 3, 4mm
25mmL	x18	PH00, PH0, PH1(x5), PH2(x5), PH3(x5), PH4	25mmL	x6	2, 2,5, 3, 4, 5, 6mm
50mmL	x3	PH1, PH2, PH3	25mmL	x6	5/64, 3/32, 7/64, 1/8, 9/64, 5/32
75mmL	x3	PH1, PH2, PH3	25mmL	x13	1,5, 6, 7, 8, 9, 10, 15, 20, 25, 27, 30,40,45
25mmL	x17	PZ00, PZ0, PZ1(x5), PZ2(x5), PZ3(x4), PZ4	25mmL	x3	1, 2, 3mm
50mmL	x3	PZ1, PZ2, PZ3	25mmL	x4	0, 1, 2, 3mm
75mmL	x3	PZ1, PZ2, PZ3	25mmL	x3	MS, M6, M8
25mmL	x14	T5, T6, T7, T8, T9, T10, T15, T20, T25, T27, T30, T35, T40, T45	25mmL	x3	0, 1, 2, 3mm
50mmL	x7	T10, T15, T20, T25, T27, T30, T40	25mmL	x9	TS10, TS15, TS20, TS25, TS27, TS30, TS40, TS45, TS50
75mmL	x7	T10, T15, T20, T25, T27, T30, T40	25mmL	x12	SL2, SL2.5, SL3, SL3.5, SL4, SL4.5, SL5, SL5.5, SL6, SL6.5, SL7, SL8
25mmL	x3	6, 8, 10mm			
50mmL	x3	6, 8, 10mm			

mm	x10	4, 5, 6, 7, 8, 9, 10, 11, 12, 13
"	x10	5/32, 3/16, 7/32, 1/4, 9/32, 5/16, 11/32, 3/8, 7/16, 1/2
6mm	x1	1/4" Adaptador
	x1	

## SET DE DESTORNILLADORES LARGOS Y CORTOS

52500

0,33 60 720

16,50€



8  
PCS



### CORTOS

x3	x5
PH00x25, PH0x25, PH1x25	SL0,4x2x25, SL0,4x2,5x25, SL0,5x3x25, SL0,5x3,5x25, SL0,8x4x25

53917

0,2 5 50

8,00€



7  
PCS



### LARGOS

x3	x5
PH00, PH0, PH1	SL1,4, SL2,0, SL2,4, SL3,0

## ESTUCHE DE DESTORNILLADORES CON PUNTAS INTERCAMBIABLES 20 EN 1

53010

0,72 5 20 600

16,50€

11  
PCS



MANGO  
ERGONÓMICO

### CONTIENE

x2	PH1, PH2
x2	4x6, 5x7mm
x3	T10x15, T20x25, T30x40
x3	H4x4mm, cabeza de bola H5x5mm, cabeza de bola H6x6mm, cabeza de bola

## DESTORNILLADOR 6 EN 1

52072

0,19 12 72 1.728

5,00€



4  
PCS

CrV

### CONTIENE

x2	PH1, PH2
x2	5, 6mm
x2	8, 9mm

## DESTORNILLADOR REVERSIBLE PLANO - ESTRELLA

54060

0,11 24 1.056

4,50€

SL6x150mm  
PH2x150mm



54061

0,11 24 1.056

4,50€

SL6x100mm  
PH2x100mm



51955

0,11 24 96 1.344

5,00€

SL6x150mm  
PH2x150mm



52068

0,11 24 96 1.056

4,50€

SL6x100mm  
PH2x100mm



EN EXPOSITOR  
DE 24 UNIDADES



## SET DE PUNTAS PARA AJUSTE DE FAROS

53729

18,00€

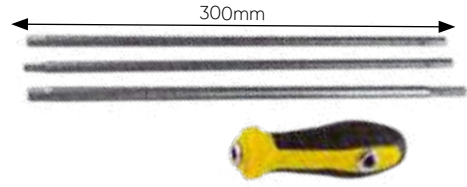
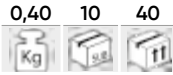

300mm H6, H7, T25

## SET DE 3 DESTORNILLADORES

51952

13,30€



PH2x100, PH2x150, PH2x200mm

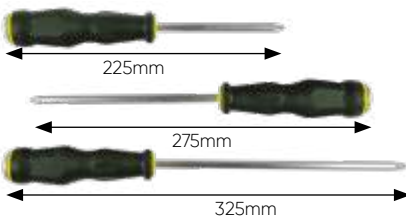

3 PCS

## JUEGO DE 4 DESTORNILLADORES PLANOS DE GOLPEO

50902

13,00€



3", 4", 6", 8"



4 PCS

## DESTORNILLADOR DE GOLPEO 1/2"

53694

17,00€



CrV 1/2" 8 PCS

CONTIENE

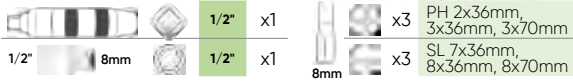

## JUEGO DESTORNILLADORES DE GOLPEO PUNTA IMANTADA

52748

43,50€



CONTIENE

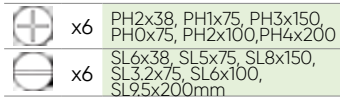

MANGOS ERGONÓMICOS



## DESTORNILLADORES CON MÓDULO EVA CARBONO

53943

18,50€

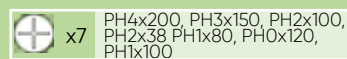

53944

18,50€



53945

18,50€

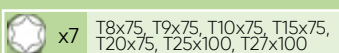

180mm 380mm 30mm

## DESTORNILLADOR FLEXIBLE

**52170**  
15,50€

0,27 12 48 672  
Kg Pz Pz Pz



1/4"

7  
PCS

4, 5, 6, 7, 8, 10mm



## DESTORNILLADOR FLEXIBLE

**53575**  
14,00€

0,40 10 40 480  
Kg Pz Pz Pz



1/4"

4  
PCS

4, 5, 7mm

CrV

500mm



## JUEGO DE 3 DESTORNILLADORES FLEXIBLES

**52169**  
25,00€

0,44 12 48 672  
Kg Pz Pz Pz



3  
PCS

6, 7, 8mm



## NIVELES

DE ALUMINIO

ISO90001:2008 RoHS CE

**53613**  
17,00€

0,55 5 30  
Kg Pz Pz

500mm

**53614**  
19,50€

0,60 5 30  
Kg Pz Pz

600mm

**53615**  
30,50€

0,85 5 20  
Kg Pz Pz

800mm



EXPOSITOR PARA NIVELES

**14183**  
31,00€

0,80 10  
Kg Pz



TUBULAR MAGNÉTICO

**53616**  
7,50€

0,30 5 60  
Kg Pz Pz

500mm

**53617**  
8,50€

0,30 5 60  
Kg Pz Pz

600mm

**53618**  
10,50€

0,35 5 30  
Kg Pz Pz

800mm





## CINTA MÉTRICA

53025	53026	53027
3,50€	5,50€	7,50€
0,13	0,26	0,4
12	12	12
48	48	48
1.500	1.500	1.500
3M x16mm	5M x25mm	7,5M x25mm



## MÓDULO EVA DE MEDICIÓN

13668	0,61	10	300
19,00€			



## CÚTER PROFESIONAL

51909	0,07	24	192	3.456
2,50€				

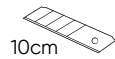

MANGO ANTIDESLIZANTE

MUY RESISTENTE

EN EXPOSITOR DE 24 UNIDADES



## MAGNETIZADOR / DESMAGNETIZADOR

53225	0,10	12	96	2.016
3,50€				



## CANDADOS

53403	0,1	8	96	38mm
6,00€				

53405	0,1	8	96	32mm
5,00€				

53406	0,5	8	48	50mm
8,00€				

53407	0,5	8	48	63mm
11,50€				

53408	0,8	3	24	840	75mm
17,50€					



## CANDADOS RESISTENTES AL AGUA

53399	0,9	8	48	30mm
3,50€				

53400	0,2	8	48	40mm
4,50€				

53401	0,35	8	48	50mm
5,00€				

53402	0,6	10	40	65mm
9,00€				



CON TAPA PROTECTORA



LARGOS

53404	0,2	8	96	38mm
6,50€				

53409	0,3	8	48	50mm
9,00€				

x3



x2



## MARTILLOS PROFESIONALES CON MANGO DE FIBRA

**52182** 2,2 6 12 504 **2 Kg** 297mm  
24,00€

**52184** 4,31 4 128 **4 Kg** 880mm  
43,00€

**52185** 6,97 4 72 **6 Kg** 895mm  
64,00€

**52186** 8,68 2 60 **8 Kg** 900mm  
72,00€



## MARTILLOS

### MARTILLO DE PEÑA

**51674** 0,5 6 36 864 **505 g**  
7,00€

**52565** 1,13 6 24 720 **1 Kg**  
11,50€



### MARTILLO DE BOLA

**51918** 1,34 6 18 432 **1 Kg**  
12,50€

**51504** 0,55 4 40 1.280 **454 g**  
8,50€



## MARTILLOS PROFESIONALES ANTI-REBOTE

**52180** 1,33 6 12 360 **1,35 Kg** 355mm  
19,00€

**52181** 1,81 6 12 300 **1,80 Kg** 370mm  
22,50€

**52183** 2,3 6 12 288 **2,20 Kg** 405mm  
26,20€

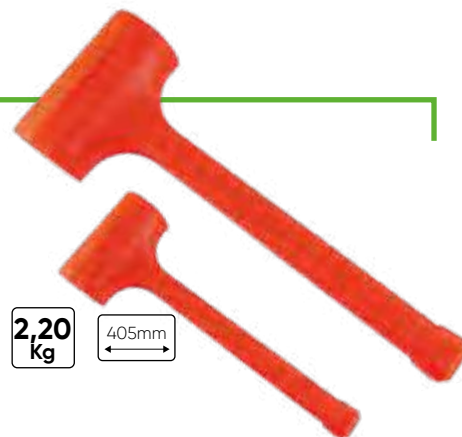

## MARTILLOS NYLON ANTI-REBOTE

**52425** 0,7 6 12 500 **Ø 40mm**  
28,50€

**52426** 1,68 2 12 180 **Ø 60mm**  
46,50€

**52427** 2,02 2 12 204 **Ø 70mm**  
61,00€



### PUNTA RECAMBIO

REF.	Ø			€
11212	40mm	0,02	5 100	5,00€
11213	60mm	0,08	5 100	10,55€
11214	70mm	0,11	5 100	12,50€





## HACHAS CON MANGO DE MADERA

**52188**

15,50€



**52461**

24,00€



**52460**

15,00€



## SIERRA DE ARCO CON MANGO ERGONÓMICO

**52830**

24,00€



EN EXPOSITOR DE 10 UNIDADES

## SIERRA DE ARCO

**52831**

18,00€

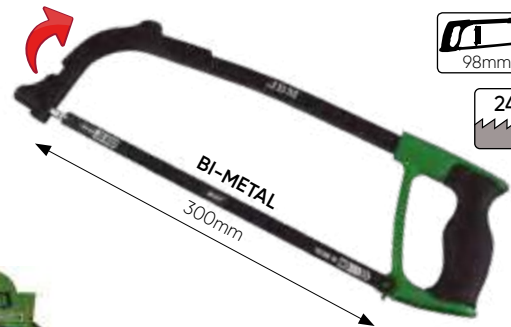
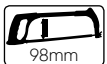
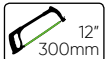

EN EXPOSITOR DE 10 UNIDADES

HOJA PARA SIERRA DE ARCO PARA REF. 52830 / 52831 / 51675

**12060**

2,50€



## SET DE 5 LIMAS DE ACERO

**51853**

18,00€

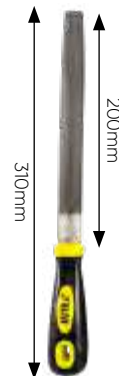

## SET DE 3 ESPÁTULAS DE ACERO

**51951**

15,60€



- Mango ergonómico

## SET 4 ESPÁTULAS DE ACERO

**53339**

9,50€



2, 3, 4, 6"

## HERRAMIENTA DE CALAFATEO DE SILICONA

**54017**

0,15 20 40  
Kg Kg Kg

40mm 305mm 115mm

12,00€

Este set puede ayudarle a reparar la brecha y limpiar el pegamento residual, mejorar la calidad de aglutinación y el sentido estético de la superficie.

- El raspador de acero inoxidable elimina el pegamento viejo y persistente.
- La paleta de silicona elimina las protuberancias y abolladuras de la superficie
- Es una buena herramienta para alisar las líneas de sellado, las líneas de calafateo.



Incluye 5 almohadillas de silicona reemplazables (3R,6R,10R,13R,17R radio)

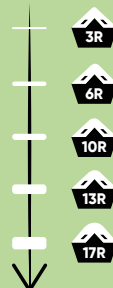

Se puede utilizar para el hogar, la cocina, el baño, la ventana, la junta del fregadero etc.

## CINCELES

**53120**

0,56 6 24  
Kg Kg Kg

150mm

6,00€



**53121**

0,55 6 24 720  
Kg Kg Kg Kg

250mm

8,00€

**53122**

0,9 6 12 432  
Kg Kg Kg Kg

350mm

9,50€

ACERO  
45C

## SET DE 4 CINCELES

**53083**

1,09 10 20  
Kg Kg Kg

54,50€

ACERO  
SNCM+V

18x125,  
21x150,  
26x200,  
29x250mm



## SET DE 5 CINCELES

**52014**

0,47 10 40 3.840  
Kg Kg Kg Kg

14,00€

10, 11, 12, 14, 16mm

ACERO  
45C

155mm



## SET DE 5 PUNZONES CÓNICOS

**52049**

14,00€

3, 4, 5, 6, 7mm

0,43 10 40 3.840  
Kg Kg Kg Kg

150mm

ACERO  
45C



## SET DE 5 BOTADORES

**52013**

14,00€

4, 5, 6, 7, 8mm

0,38 10 40 3.840  
Kg Kg Kg Kg

150mm

ACERO  
45C

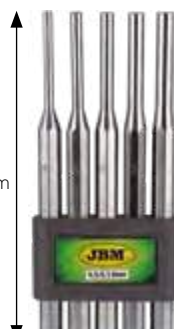

## SET DE 6 BOTADORES

**53095**

18,00€

0,8 6 24  
Kg Kg Kg

CrV

3, 4, 5, 6,  
7, 8mm



150mm



## REMACHADORA ARTICULADA MULTIFUNCIÓN

**53993**

66,50€

1,82 5 10  
Kg Kg Kg

- Cabezal giratorio 360°
- Compacta, facilita el trabajo en espacios pequeños
- Diseño para trabajar con una sola mano

Contiene:

- Boquillas para remaches estándar de 2,4mm (3/32") - 3,2mm (1/8") - 4,0mm (5/32") - 4,8mm (3/16")
- Punzones para tuercas remachables M3x0,5 - M4x0,7 - M5x0,8 - M6x1
- Punzones para remaches M6x1 - M5x0,8 - M4x0,7
- 3 llaves de 5,5x8,5mm - 12x17mm - 15x19mm
- Portamandriles M6x1 - M5x0,8 - M4x0,7 - M3x0,5



2,4mm (3/32")  
4,0mm (5/32")  
4,8mm (3/16")



## REMACHADORA TUERCA COMPACTA

200MM / 8"

**52595**

1,30 10 140

58,00€



200mm

8"

M3, M4,  
M5, M6



## REMACHADORA COMPACTA

200MM / 8"

**52462**

0,56 5 30 900

24,00€



8"

200mm

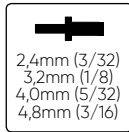

**13667**

18,00€

MÓDULO EVA  
REMACHADORA  
Y REMACHES

0,83 10 360



## REMACHADORA 300MM / 12"

**52463**

0,74 20 280

24,50€



300mm

12"

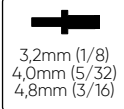

## REMACHADORA 400MM / 16"

**52464**

0,68 5 10 210

39,00€



400mm

16"

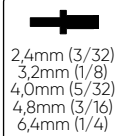

## REMACHADORA DE TUERCA

400MM / 16"

**52596**

3,07 5 75

112,00€



400mm

16"

M3, M4, M5,  
M6, M8,  
M10, M12



## REMACHADORA TUERCA AUTOMÁTICA

440MM / 17"

**52597**

3,25 5 80

128,50€



440mm

17"

M3, M4, M5,  
M6, M8,  
M10, M12



## MACHOS RECAMBIO PARA REMACHADORA DE TUERCA REF. 52595, 52596, 52597



REF.	DESCRIPCIÓN	kg	fl	mm	€
13226	M3	0,03	100		4,50 €
13227	M4	0,04	100		4,50 €
13228	M5	0,04	100		4,50 €
13229	M6	0,04	100		4,50 €

REF.	DESCRIPCIÓN	kg	fl	mm	€
13230	M8	0,04	100		4,50 €
13231	M10	0,05	100		4,50 €
13232	M12	0,05	100		4,50 €

## REMACHADORA DE EMPUJE 10"/250mm

**53331**

0,80 5 20 280

29,50€



250mm 10"



2,4mm (3/32)  
3,2mm (1/8)  
4,0mm (5/32)  
4,8mm (3/16)  
6,4mm (1/4)

## REMACHADORA DE ACORDEÓN 8"/200mm

**53332**

1,65 5 10 280

32,00€



200mm 8"



2,4mm (3/32)  
3,2mm (1/8)  
4,0mm (5/32)  
4,8mm (3/16)

## SET DE REMACHADORA + REMACHES PLÁSTICOS

**52609**

0,50 10 20 240

29,00€



Ø 6,6mm x 17,2mm (10 u.)  
Ø 6,3mm x 25,2mm (10 u.)  
Ø 5mm x 17,2mm (10 u.)  
Ø 5mm x 15,8mm (10 u.)

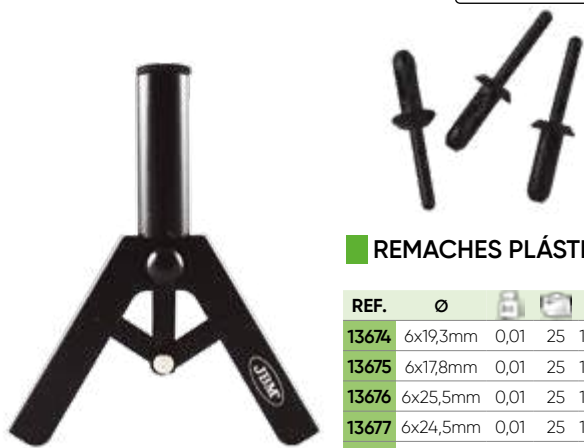

### REMACHES PLÁSTICOS

REF.	Ø				€
13674	6x19,3mm	0,01	25	1.000	0,50€
13675	6x17,8mm	0,01	25	1.000	0,50€
13676	6x25,5mm	0,01	25	1.000	0,50€
13677	6x24,5mm	0,01	25	1.000	0,50€
13678	6x24mm	0,01	25	1.000	0,50€

## REMACHADORA NEUMÁTICA

**52575**

1,71 5 10 200

99,50€



2,4mm (3/32), 3,2mm (1/8)  
4,0mm (5/32), 4,8mm (3/16)

- Tracción: 1586LBS / 720 KGS.
- Largo de varilla: 9/16" - 14mm.
- Max. apriete 60FT IB / 23-69NM.
- Consumo aire media: 0,03CFM/0,86L/Min.
- Entrada de aire: 1/4".

- Contiene:
- Cubeta trasera receptora
  - 2 Multiherramientas
  - Enganche rápido
  - Juntas tóricas



REMACHES DISPONIBLES EN PÁG. 321

## CARRACA 72 DIENTES CON VASOS



1/2"

10, 11, 12, 13, 14, 15, 16, 17, 18, 19mm

**54028**

1,22 4 24 384

29,00€



**52948**

1,22 4 24 384

27,00€



1/2"

10, 11, 12, 13, 14, 15, 16, 17, 18, 19mm

**54029**

1,22 4 24 384

29,50€



**52949**

1,22 4 24 384

29,00€



1/4"

4, 5, 6, 7, 8, 9, 10, 11, 12, 13mm

**54030**

0,35 6 36 864

18,00€



**52950**

0,35 6 36 864

17,00€



1/4"

4, 5, 6, 7, 8, 9, 10, 11, 12, 13mm

**54031**

0,35 6 36 864

18,00€



**52951**

0,34 6 36 864

17,50€





## SET DE 3 CARRACAS MINI

53671

37,00€

0,84 20  
Kg fl

- Incluye:  
1 carraca mini de 1/4".  
1 carraca mini de 1/2".  
1 carraca mini de 3/8".

PRESENTACIÓN  
EN EVA



72 3  
PCS

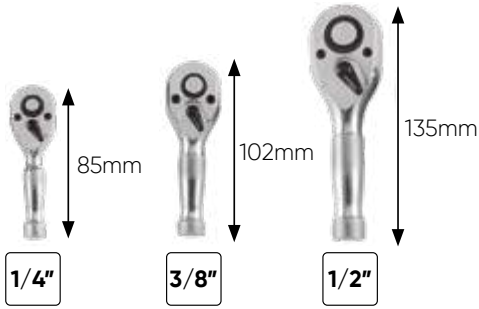

SET DE REPARACIÓN  
CARRACA MINI DE  
1/2"

15140 0,20 50  
12,00€ Kg fl

SET DE REPARACIÓN  
CARRACA MINI DE  
3/8"

15139 0,15 50  
10,50€ Kg fl

SET DE REPARACIÓN  
CARRACA MINI DE  
1/4"

15138 0,10 50  
9,50€ Kg fl

## CARRACA 72 DIENTES

CROMADA

CINCADA

54022

9,50€

0,15 12 36 2.592  
Kg fl fl fl

1/4"

145mm

53098

11,00€

0,15 12 36 2.592  
Kg fl fl fl

1/4"

145mm

54023

12,50€

0,29 12 24  
Kg fl fl

3/8"

200mm

53099

13,00€

0,29 12 24  
Kg fl fl

3/8"

200mm

54024

17,00€

0,59 12 24 963  
Kg fl fl fl

1/2"

255mm

53100

17,00€

0,59 12 24 963  
Kg fl fl fl

1/2"

255mm

54022/54023/54024



53098/53099/53100



EN EXPOSITOR  
DE 12 UNIDADES

54018

9,50€

0,15 12 36 2.592  
Kg fl fl fl

1/4"

145mm

51382

10,00€

0,15 12 36 2.592  
Kg fl fl fl

1/4"

145mm

54021

12,50€

0,28 12 24  
Kg fl fl

3/8"

200mm

51270

12,00€

0,28 12 24  
Kg fl fl

3/8"

200mm

54019

17,00€

0,6 12 24 963  
Kg fl fl fl

1/2"

255mm

51921

16,00€

0,6 12 24 960  
Kg fl fl fl

1/2"

255mm

54018/54019/54021



51382/51270/51921



EN EXPOSITOR  
DE 12 UNIDADES

## CARRACA DE 24 DIENTES CINCADA

51285

9,00€

0,15 12 36 2.592  
Kg fl fl fl

1/4"

155mm

24



EN EXPOSITOR  
DE 12 UNIDADES

51287

14,00€

0,55 12 24 960  
Kg fl fl fl

1/2"

260mm



## CARRACA DE 72 DIENTES CINCADA

52207

16,50€

0,05 12 240 8.400  
Kg fl fl fl

1/4"

85mm

72



EN EXPOSITOR  
DE 12 UNIDADES



## CARRACA DE 72 DIENTES ARTICULADA

**52587** 0,16 12 144 3.456 **1/4"** 175mm  
28,50€



EN EXPOSITOR DE 12 UNIDADES



**51305** 0,31 12 48 816 **1/2"** 170mm



EN EXPOSITOR DE 12 UNIDADES

72



**52588** 0,17 12 144 3.456 **1/2"** 175mm

**51306** 0,30 12 48 816 **1/4"** 170mm

## CARRACA DE 72 DIENTES DE CABEZAL GIRATORIO

## CARRACA DE 48 DIENTES CABEZA ROTATIVA

**51405** 0,15 12 48 1.008 **1/4"** 145mm

**52585** 0,15 12 72 2.160 **1/4"** 185mm

**51406** 0,66 12 24 960 **1/2"** 280mm

**52586** 0,73 12 24 768 **1/2"** 310mm

EN EXPOSITOR DE 12 UNIDADES



EN EXPOSITOR DE 12 UNIDADES



## CARRACA EXTENSIBLE 72 DIENTES

## CARRACA ARTICULADA EXTENSIBLE DE 1/2" 72 DIENTES

**53346** 0,25 6 12 **1/4"** 165-215mm

**52197** 1,04 6 12 480 **1/2"** 350-490mm

**51307** 0,92 6 12 540 **1/2"** 305-445mm

- Acero forjado con tratamiento térmico.

EXTENSIBLE

MANGO EXTENSIBLE

ROTACIÓN 180°

MANGO EXTENSIBLE



EN EXPOSITOR DE 6 UNIDADES



EN EXPOSITOR DE 6 UNIDADES



EN EXPOSITOR DE 6 UNIDADES



## CARRACA ARTICULADA EXTRA LARGA DE 72 DIENTES

**53886** 0,27 10 40 **1/4"** 305mm  
18,00€

**CrV** **72**

PUNTA RECAMBIO  
1/4" PARA REF. 53886  
**15149** 0,05 100  
4,50€

**53887** 0,68 10 20 **3/8"** 457mm  
26,00€

**53888** 1,27 4 16 **1/2"** 609mm  
32,50€

PUNTA RECAMBIO  
3/8" PARA REF. 53887  
**15147** 0,20 100  
4,50€

PUNTA RECAMBIO  
1/2" PARA REF. 53888  
**15148** 0,20 100  
4,50€

## CARRACA EXTRA LARGA DE 72 DIENTES

**53883** 0,27 10 40 **1/4"** 305mm  
16,50€

**CrV** **72**

PUNTA RECAMBIO  
1/4" PARA REF. 53883  
**15149** 0,05 100  
4,50€

**53884** 0,61 10 20 **3/8"** 457mm  
26,00€

**53885** 1,25 4 16 **1/2"** 609mm  
30,50€

PUNTA RECAMBIO  
3/8" PARA REF. 53884  
**15147** 0,20 100  
4,50€

PUNTA RECAMBIO  
1/2" PARA REF. 53885  
**15148** 0,20 100  
4,50€

## CARRACA FLEXIBLE DE 72 DIENTES DE 3/8"

**51801** 0,57 40 160 **3/8"** 500mm  
62,00€

- Muy útil en lugares de difícil acceso.



## LLAVE EN CRUZ UNIÓN SOLDADA

**51661** 1,17 5 20 480  
11,50€

355mm 17, 19, 21mm

**1/2"**

**52881** 1,4 10 420  
17,00€

400mm 17, 19, 21, 22mm

**1/2"**

**52880** 3,75 5 100  
38,50€

700mm 24, 27, 32mm

**3/4"**

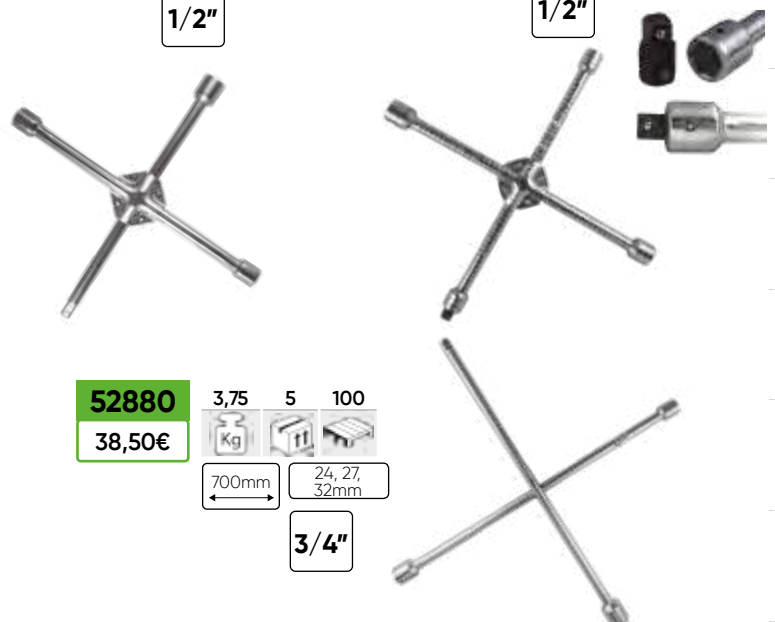

## ADAPTADOR CON CORREDERA

**53478** 0,5 5 100 700 **1/4"** 115mm  
5,00€

**53479** 0,15 5 50 300 **3/8"** 200mm  
6,50€

**53468** 0,35 6 48 **1/2"** 250mm  
10,50€

**53480** 1,35 5 10 300 **3/4"** 460mm  
19,50€

**53481** 2,85 5 300 **1"** 550mm  
29,30€



## MANERALES

**52524** 3,65 3 6 192 **3/4"** 1.020mm  
51,50€

**52526** 1,83 5 10 500 **1/2"** 600mm  
27,50€

**52525** 0,78 10 20 1.920 **1/2"** 430mm  
12,50€

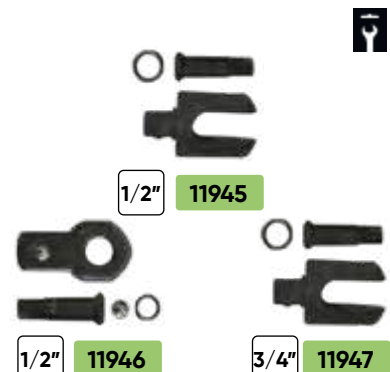

REF.	"	PARA	Kg	Ud.	Fl.	€
11945	1/2"	52526	0,02	25	100	7,00€
11946	1/2"	52525	0,06	25	300	4,50€
11947	3/4"	52524	0,01	10	40	19,00€

## SET DE BARRAS DE EXTENSIÓN DE 1/4"

**51447** 0,34 20 1.000  
16,00€



**1/4"** 50, 75, 100, 152, 227mm

### DESPIECE DISPONIBLE

REF.	mm	Kg	Ud.	Fl.	€
14026	50mm	0,03	5	100	5,50 €
14027	75mm	0,04	5	100	5,60 €
14028	100mm	0,06	5	100	7,00 €
14029	152mm	0,08	5	100	8,50 €
14030	227mm	0,11	5	100	9,50 €



## SET DE BARRAS DE EXTENSIÓN DE 1/4" CON CABOTA REDONDA

**51805** 0,34 5 20 1.000  
17,00€



**1/4"** 50, 75, 100, 152, 227mm

### DESPIECE DISPONIBLE

REF.	mm	Kg	Ud.	Fl.	€
12995	50mm	0,03	5	100	7,00€
12996	75mm	0,04	5	100	7,00€
12997	100mm	0,06	5	100	7,50€
12998	152mm	0,08	5	100	9,00€
12999	227mm	0,11	5	100	9,50€



## SET DE BARRAS DE EXTENSIÓN DE 1/2" CON CABOTA REDONDA

**51448** 2,38 5 280  
51,35€



**1/2"** 50, 125, 250, 380, 510mm

### DESPIECE DISPONIBLE

REF.	mm	Kg	Ud.	Fl.	€
14978	50mm	0,09	5	100	7,50€
14979	125mm	0,21	5	100	9,00€
14980	250mm	0,40	5	100	13,00€
14981	380mm	0,62	5	50	22,50€
14982	510mm	0,83	5	50	27,50€





## BARRA EXTENSIÓN DE 1/2" CON CABOTA REDONDA

51479

0,65 12 24 1.056

29,00€

Kg Kg Kg Kg

260-410mm

1/2"



EN EXPOSITOR  
DE 12 UNIDADES



6 POSICIONES

## ALARGADOR FLEXIBLE CON PUNTA DE 4 GARRAS

51526

0,09 12 144 1.728

9,80€

Kg Kg Kg Kg

500mm

Ø 20mm

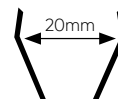
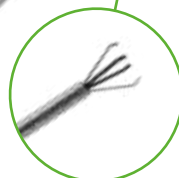

## ALARGADOR FLEXIBLE IMANTADO CON LED

52473

0,18 10 60 900

8,00€

Kg Kg Kg Kg

x1

545mm

Ø 15mm



## PUNTA IMANTADA EXTENSIBLE

52472

0,04 12 108 4.320

4,90€

Kg Kg Kg Kg

135-600mm

Ø 10mm



2,5 Kg



## ALARGADOR FLEXIBLE CON PUNTA IMANTADA

51525

0,14 10 60 1.440

9,80€

Kg Kg Kg Kg

500mm

Ø 7mm



0,5 Kg



EXTRAFINA

## EXTENSIBLE IMANTADO CON PUNTA DE LED

51272

0,08 12 72 1.440

7,50€

Kg Kg Kg Kg

90-810mm

Ø 15mm

x1



EN EXPOSITOR  
DE 12 UNIDADES

## ESPEJO DE INSPECCIÓN TELESCÓPICO ARTICULADO

52468

0,09 12 48 2.688

5,90€

Kg Kg Kg Kg

280-445mm

280-445mm



Ø 50MM



## NAVAJA CON SISTEMA CORTA CINTURONES Y ROMPE CRISTALES

**52786** 0,16 12 60 2.100  
14,00€



CON SEGURO ANTICIERRE



## CORTATUBOS

**52878** 0,22 10 50 1.500  
11,20€



3-32mm

**53517** 0,13 10 60 600  
9,50€

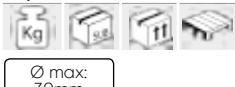

Ø max: 30mm

**52877** 0,43 48 720  
13,80€



42mm

**52879** 0,24 10 50 1.500  
11,20€



3-35mm



52878

52879



REF.	DESCRIPCIÓN	PARA	U	€
12964	Rueda de acero	52878	0,01	1,50€
12965	Rueda de acero	52879	0,01	2,00€

## CURVADORA DE TUBO 6-8-10MM

**52905** 0,50 10 30  
28,00€



6, 8, 10mm



TUBOS DE ALUMINIO, COBRE Y ACERO



GRADOS MARCADOS

## CUCHILLO PELACABLES

**53591** 0,1 10 100  
5,50€



↑ 28mm  
↓ 8mm



- Rango de corte: 8-28mm.
- Largo del producto: 170mm.
- Largo de la cuchilla: 20mm.
- Profundidad del gancho: 5mm.

## ALICATES PELACABLES MINI

**53411** 0,05 12 120  
5,00€



127mm



**53412** 0,05 12 120  
4,00€



94mm





## HERRAMIENTA PELA-CABLES AUTOAJUSTABLE

**51972**

0,25 10 100 800

0,08-6mm

12,00€



- Para pelar cables de plástico o caucho, individual o múltiple, con secciones desde 0.25 a 2.5mm<sup>2</sup>.
- Ajuste automático del grueso de decapado para las diferentes secciones.
- En cables de cobre y aluminio, posibilidad de pelar varios cables a la vez con sección de 2.5mm<sup>2</sup> como máximo.
- Posibilidad de pelar cable individual a partir de 0.25mm<sup>2</sup> de sección.
- No provoca daños en el hilo conductor.
- Alta durabilidad.

## ALICATES PARA TERMINALES

PARA TERMINALES AISLADOS Y NO AISLADOS

**52761**

8,00€



0,25 12 72 1.296



9"



**53932**

8,00€



MÓDULO EVA PELACABLES Y TERMINALES

**13669**

0,61 10 360

18,00€



PARA TERMINALES NO AISLADOS

**52762**

9,00€

0,25 12 72 1.296



8 - 3/4"



## JUEGO DE ALICATES PARA DESCONEXIÓN DEL TUBO DE COMBUSTIBLE

**53445**

17,00€

0,35 12 48 384



## ALICATE CORTACABLES

**53604**

111,00€

3,7 5 120



800mm

Sección de corte max. Ø 550 mm<sup>2</sup>

**53603**

44,00€

1,75 5 300



550mm

Sección de corte max. Ø 250 mm<sup>2</sup>

**53602**

27,50€

0,6 5 300



360mm

Sección de corte max. Ø 125 mm<sup>2</sup>



53602

53603

53604

## TIJERAS CORTACABLE

**52152**

13,50€

0,08 12 96 1.440



140mm

ACERO INOXIDABLE



## ALICATE PARA EXTRACCIÓN DE GRAPAS DE CARROCERÍA

**53385**

18,00€

0,15 6 54 499



CORTAR



EXTRAER



BRIDAR



- PUNTA EN ÁNGULO:
- Diseñado para extraer / cortar grapas / clips fácilmente y sin daño.
  - Permite un fácil acceso a áreas confinadas.

## ALICATES SEEGER BOCA RECTA

PARA INTERIORES

**53549** 0,4 5 30  
13,30€

330mm 13"

**52964** 0,23 6 60 1.260  
9,00€

225mm 9"

**51018** 0,15 5 100 1.400  
6,50€

180mm 7"



PARA EXTERIORES

**53547** 0,4 5 30  
13,50€

330mm 13"

**52966** 0,25 5 60 1.440  
9,00€

225mm 9"

**51017** 0,13 5 100 1.400  
6,50€

180mm 7"



CrV



## ALICATES SEEGER BOCA CURVA

PARA INTERIORES

**53550** 0,4 5 30  
13,30€

330mm 13"

**52965** 0,24 6 60 1.440  
9,00€

225mm 9"

**51021** 0,16 5 100 1.400  
6,50€

180mm 7"



PARA EXTERIORES

**53548** 0,4 5 30  
13,30€

330mm 13"

**52967** 0,24 6 60 1.440  
9,00€

225mm 9"

**51020** 0,13 5 100 1.400  
6,50€

180mm 7"



CrV



## MÓDULO EVA DE ALICATES SEEGER 8"

**15454** 0,95 10 220  
33,00€

REF.	Ø	kg	€
10526	ALICATE SEEGER PARA INTERIORES BOCA RECTA 8"	0,21	10,00€
10642	ALICATE SEEGER PARA INTERIORES BOCA CURVA 8"	0,22	10,00€
10643	ALICATE SEEGER PARA INTERIORES BOCA CURVA 8"	0,21	10,00€
10644	ALICATE SEEGER PARA EXTERIORES BOCA CURVA 8"	0,22	10,00€



8"

## SET DE ALICATES SEEGER CON PUNTA INTERCAMBIABLE

**53389** 1,15 10 160  
31,50€

Ángulo de puntas:  
90° / 45° / 15° / 0°

10"

- Contiene:
- Alicate interno.
  - Alicate externo.
  - 16 puntas de diferentes ángulos.
  - 8 tornillos.



## KIT DE 3 ALICATES DE MORDAZA EXTRALARGOS

**52982** 1,6 4 8 400  
49,00€

37cm: punta recta  
36cm: ángulo de 45°  
34cm: ángulo de 90°

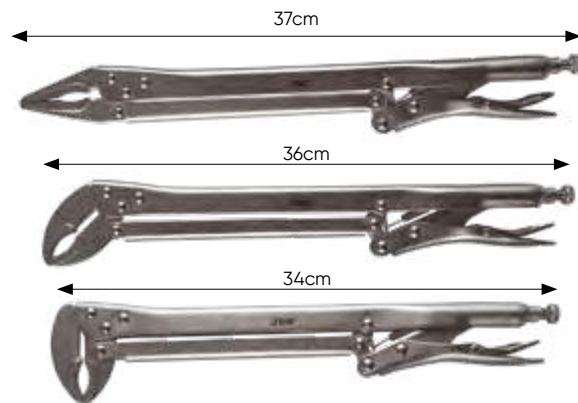



## ALICATE EXTRALARGA

RECTO

52846

0,4 60 1.500

37,80€

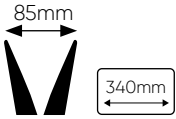

CURVADO 45°

52847

0,4 60 1.500

37,80€

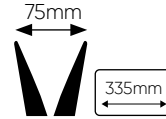

## SET ALICATES PUNTA DE 0°, 45° Y 90°

52272

1 5 10 280

28,00€

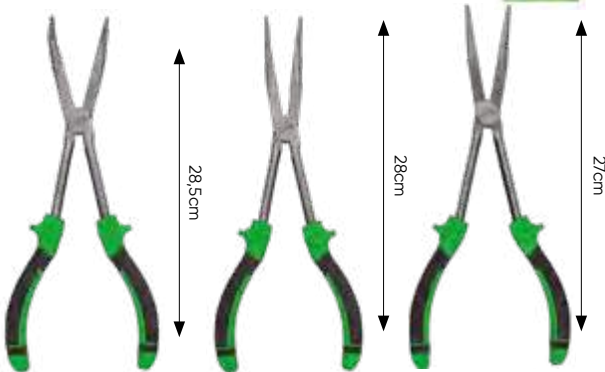

## SET DE 5 ALICATES EN ESTUCHE

51812

1,45 5 10 240

44,00€



## ALICATE DE PINZA AJUSTABLE

52052

1,88 5 10 400

46,50€



50567

0,34 10 60 1.020

9,60€



## JUEGO DE 6 ALICATES MINI DE 120MM

50580

0,47 5 40 1.200

11,00€



- Alicate Universal.
- Alicate Punta.
- Alicate Corte.
- Alicate Pelacable.
- Alicate SEEGER.
- Alicate universal plano.

## ALICATE MINI PLEGABLE MULTIUSOS

52412

0,09 24 144 5.760

5,00€



105mm

### CONTIENE

- x2 destornillador plano
- x1 punta estrella
- x1 abrebotellas
- x1 abrelatas
- x1 lima 25mm
- x1 hojas de sierra 40mm
- x1 hoja de corte 40mm



## ALICATE UNIVERSAL

**53911**

8,00€

0,2

6

60

6"

160mm



53911/54015/53967

**54015**

9,00€

0,20

6

60

1.440

7"

180mm

**53967**

9,50€

0,30

6

60

1.440

8"

200mm

## ALICATE DE PUNTA ESPECIAL TERMINALES

**53976**

8,00€

160mm

6"

CrV

0,20

6

60

1.440



## ALICATE PARA ABRAZADERAS

**53390**

34,50€

0,85

10

20

480



SET DE RECAMBIOS  
PARA REF. 53390

**14180**

7,90€

0,01

100



**51995**

24,50€

0,59

5

40

480



SET DE RECAMBIOS  
PARA REF. 51995

**14179**

8,50€

0,01

100



## ALICATE PARA ABRAZADERAS DE TUBOS DE ESCAPE

**53396**

18,00€

0,5

5

50



## ALICATE ESPECIAL ABRAZADERAS TUBO TIPO CLIC-R

**52791**

18,00€

0,27

5

50

1.500



175mm



- Para el tipo de Clic y Clic-R (tipo aro).



# SET DE ALICATES PARA ABRAZADERAS

**52050**

3,24 4 72  
Kg fl

98,00€

- Alicates para abrazaderas que permiten la extracción de abrazaderas auto-ajustables de plástico y/o metal de diámetros 148mm a 47mm.
- Alicates para abrazaderas de mordaza pivotante con ranura en "+".
- Alicates para abrazaderas de mordaza giratoria.
- Alicates para abrazaderas de banda plana. La mordaza gira 360° para agarrar en cualquier ángulo. Para abrazaderas modernas.
- Alicates para extracción de tubos. Muy útiles para la fácil extracción de tubos de vacío y combustible de 5/32" hasta 1/2".
- Alicates de anillo click-R. Uso para aflojar y reajustar abrazaderas reajustables de tipo click-R.



B C F G E D



REF.	DESCRIPCIÓN	B	C	Fl	€
13707	alicate para abrazaderas elásticas con punta rotativa	0,25	10	40	14,00€
13708	alicate para abrazaderas elásticas	0,25	10	40	14,00€
13709	alicate para abrazaderas elásticas con punta recta	0,24	10	40	14,00€
13710	alicate para abrazaderas elasticas 45°	0,21	10	40	14,00€

REF.	DESCRIPCIÓN	B	C	Fl	€
52791	alicate para abrazaderas clic y clic-r	0,27	10	50	18,00€
13712	alicate para la extracción de tubos	0,21	10	40	14,00€
51995	alicate con cable para abrazaderas	0,59	5	40	24,50€



## ALICATE ABRAZADERA PARA FUELLE PALIER

**52619**

0,56 6 36 648  
Kg fl

23,10€



0-20mm

- Agujeros de 1/2" en los mangos para usar con llave.

**52812**

0,87 5 20 500  
Kg fl

64,50€

- Dado hembra de 3/8" para apriete con carraca.

## MORDAZA ABRAZADERA

**52508**

0,37 10 50 800  
Kg fl

33,00€

0-38mm



CrMo



PESTAÑA DE BLOQUEO

240mm

**52509**

0,39 10 50 800  
Kg fl

33,60€

22-55mm



## ALICATE PARA TUBO DE COMBUSTIBLE

**53487**

0,3 10 40 720  
Kg fl

16,00€

Audi / VW, Fiat, GM, Mercedes



IVA no incluido



www.jbmcamp.com

## ALICATE ESPECIAL FRENOS

**52389** 0,32 5 50 600  
29,00€



- Para separar el pistón de freno del disco en sistemas de freno en motocicletas y vehículos.



PESTAÑA DE BLOQUEO

## SET DE 2 GANCHOS PARA EXTRAER GOMAS EN TUBO DE ESCAPE

**52852** 0,07 25 100  
6,80€



- Para extracción de juntas tóricas.



## JUEGO DE 12 SACABOCADOS

**52885** 1,1 5 20 600  
18,00€



3, 4, 5, 6, 7, 8, 9, 10,  
12, 14, 16, 19mm

12  
PCS



## TENZA PERFORADORA ROTATIVA

**52638** 0,26 5 30  
9,00€



∅ 2, 2.5, 3,  
3.5, 4, 4.5mm



## ALICATES PARA FRENO DE TAMBOR

**52625** 0,32 6 48  
9,00€



- Para extraer e instalar resortes de retorno en frenos de tambor.

## ALICATE ESPECIAL PARA CONTRAPESAS

**51355** 0,45 5 50 500  
18,00€



- Extrae fácilmente y sustituye la contrapesa.
- Corta y dobla con facilidad.
- Hecho de acero reforzado al calor.
- Incluye mango ergonómico.
- Con muelle automático en abierto en el asa para facilitar su operación.

## GRAPADORA INDUSTRIAL

**53589** 0,55 40  
12,00€



1008J-1



PAQUETE DE 1000 GRAPAS  
PARA REF. 53589

**14167** 0,1 50 100  
2,50€



## CEPILLO METÁLICO

**52760** 0,09 12 120 2.160  
4,10€



**52515** 0,15 6 72 800  
9,10€



3  
PCS

225mm



- 1 x Latón.
- 1 x Nylon.
- 1 x Acero.





## SET DE LLAVES DE GANCHO

**53654**  
74,00€

1,4 5 180  
Kg   

- Kit compuesto por 3 llaves de gancho, 3 adaptadores y 2 pasadores intercambiables.  
- Su combinación permiten trabajar con diámetros desde 35mm a 120mm.

**8**  
PCS

35-60, 60-90,  
90-120mm

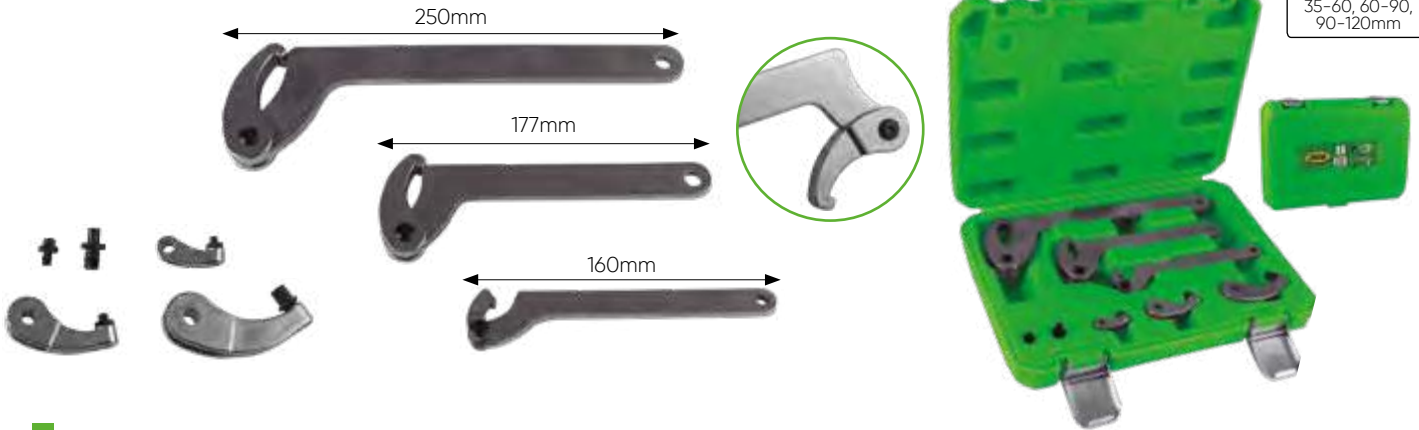

## ESTUCHE DE LLAVES ROMPETUERCAS

**53524**  
46,00€



1,7 5 10 340  
Kg   

9-12, 12-16,  
16-22, 22-36mm

**4**  
PCS























### DESPIECE DISPONIBLE

REF.	DESCRIPCIÓN			€
14049	9-12mm (1/8"-1/2")	0,11	50	8,00€
14050	12-16mm (1/2"-5/8")	0,2	50	10,50€
14051	16-22mm (5/8"-7/8")	0,44	50	18,00€
14052	22-34mm (7/2"-1-3/8")	0,65	50	19,50€



## LLAVE INGLESA

### MODELO 3

<b>53639</b> 22,50€	0,15 6 96 576 Kg    	<b>6"</b>  150mm
<b>53640</b> 29,50€	0,28 6 72 504 Kg    	<b>8"</b>  200mm
<b>53641</b> 34,00€	0,50 6 36 1.151 Kg    	<b>10"</b>  250mm
<b>53642</b> 42,50€	0,83 6 24 1.200 Kg    	<b>12"</b>  300mm

**53643** 1,53 12 336  
79,00€ Kg   

**16"**  400mm





### MODELO 1

<b>51798</b> 35,00€	1,96 3 12 295 Kg   	<b>18"</b>  53mm
<b>52424</b> 56,00€	3,64 1 5 175 Kg   	<b>24"</b>  62mm



### MODELO 2

<b>51795</b> 9,00€	0,28 6 120 3.600 Kg    	<b>8"</b>  22mm
<b>51796</b> 14,00€	0,48 6 36 2.400 Kg    	<b>10"</b>  28mm
<b>51797</b> 18,00€	0,71 6 24 1.200 Kg   	<b>12"</b>  37mm



## LLAVE STILLSON

<b>52235</b> 11,00€	0,85 Kg	6 caj.	36 fl.	1.140 fl.	<b>12"</b>	300mm	50mm
<b>52236</b> 12,50€	1,09 Kg	6 caj.	24 fl.	760 fl.	<b>14"</b>	350mm	60mm
<b>52237</b> 17,00€	0,30 Kg	4 caj.	12 fl.	720 fl.	<b>18"</b>	450mm	70mm
<b>52238</b> 23,50€	3,08 Kg	2 caj.	12 fl.	600 fl.	<b>24"</b>	600mm	75mm
<b>53210</b> 45,00€	4,8 Kg	4 caj.	128 fl.		<b>36"</b>	915mm	100mm

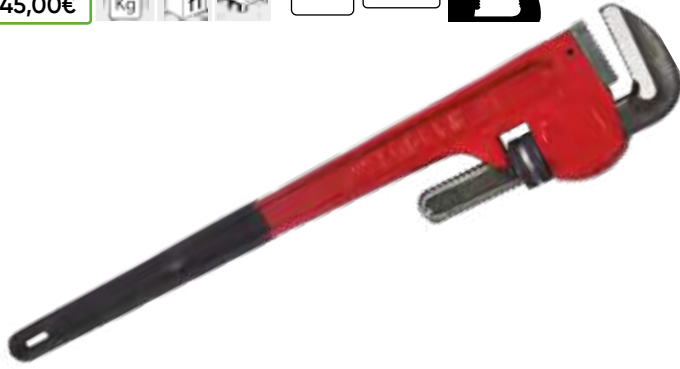

## LLAVE STILLSON ALUMINIO

<b>53070</b> 16,00€	0,68 Kg	6 caj.	24 fl.		<b>12"</b>	270mm	45mm
<b>53071</b> 19,00€	0,92 Kg	4 caj.	12 fl.		<b>14"</b>	320mm	50mm
<b>53072</b> 29,00€	1,41 Kg	4 caj.	16 fl.		<b>18"</b>	410mm	70mm
<b>53073</b> 46,00€	2,12 Kg	2 caj.	8 fl.	1.000 fl.	<b>24"</b>	540mm	75mm



## CORTAVARILLAS

<b>52955</b> 21,00€	0,77 Kg	20 caj.	200 fl.		<b>12"</b>	300mm	HRC 30 Ø 4-5mm
<b>52956</b> 22,00€	0,95 Kg	20 caj.	200 fl.		<b>14"</b>	350mm	HRC 30 Ø 5-7mm
<b>52957</b> 25,50€	1,47 Kg	12 caj.	204 fl.		<b>18"</b>	450mm	HRC 30 Ø 6-8mm
<b>52958</b> 30,95€	2,41 Kg	10 caj.	168 fl.		<b>24"</b>	600mm	HRC 30 Ø 8-10mm
<b>52959</b> 38,65€	3,78 Kg	5 caj.	100 fl.		<b>30"</b>	750mm	HRC 30 Ø 10-13mm
<b>52960</b> 47,05€	4,75 Kg	4 caj.	96 fl.		<b>36"</b>	900mm	HRC 30 Ø 12-16mm



## MORDAZAS DE SUJECIÓN 9 TAMAÑOS DISTINTOS

<b>52349</b> 18,50€	1,25 Kg	10 caj.	480 fl.		90x200mm
<b>52350</b> 21,00€	1,41 Kg	10 caj.	540 fl.		90x300mm
<b>52351</b> 23,00€	1,60 Kg	10 caj.	480 fl.		90x400mm
<b>52352</b> 27,00€	1,99 Kg	10 caj.	360 fl.		120x300mm
<b>52353</b> 28,00€	2,2 Kg	10 caj.	350 fl.		120x400mm
<b>52354</b> 32,00€	2,41 Kg	6 caj.	300 fl.		120x500mm
<b>52355</b> 36,00€	2,62 Kg	4 caj.	300 fl.		120x600mm
<b>52357</b> 47,00€	4,75 Kg	4 caj.	125 fl.		150x800mm
<b>52358</b> 54,50€	5,35 Kg	2 caj.	120 fl.		150x1.000mm

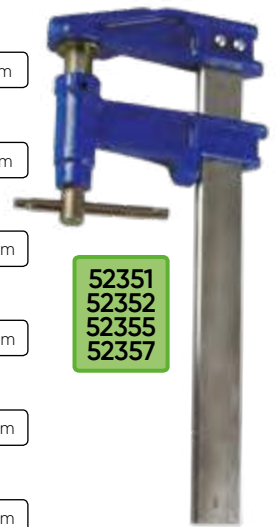

**52351  
52352  
52355  
52357**



**52349  
52350  
52353  
52354  
52358**



CARROS DE HERRAMIENTAS

68



MÓDULOS

76



ACCESORIOS / RECAMBIOS PARA CARROS

79



ARMARIOS

80



GANCHOS

80



MESAS DE TRABAJO

81



CAJAS DE HERRAMIENTAS

82



TABURETES / CAMILLAS

84

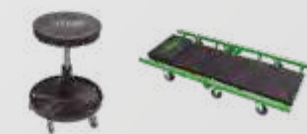

BOLSAS / MOCHILAS

85



YUNQUES / TORNILLOS DE BANCO

86



# MOBILIARIO DE TALLER



# CARRO DE HERRAMIENTAS 12 CAJONES

**53939** 98,7 1 4  
1.280,00€ CAJÓN

**53868** 83,50 1 4  
1.090,00€ VACÍO

**172**  
PCS

ARMARIOS

**ACCESORIOS Y RECAMBIOS**  
página 79

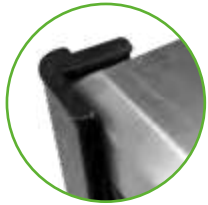

PROTECTOR LATERAL



BLOQUEO CENTRAL



PESTAÑA DE CIERRE INDIVIDUAL POR CAJÓN



CON MÓDULOS EVA:  
SET DE 4 MÓDULOS EVA  
ACABADO EN FIBRA DE CARBONO

**53708**  
292,00€

## MEDIDAS INTERIOR 1A COLUMNA

- CAJONES PEQUEÑOS (x4)  
**A** 75mm x 533mm x 400mm **35kg**  
 CAJÓN MEDIANO (x1)  
**B** 154mm x 533mm x 400mm **35kg**  
 CAJÓN GRANDE (x1)  
**C** 233mm x 533mm x 400mm **35kg**

## MEDIDAS INTERIOR 2A COLUMNA

- CAJONES PEQUEÑOS (x4)  
**D** 75mm x 265mm x 400mm **35kg**  
 CAJÓN MEDIANO (x1)  
**E** 154mm x 265mm x 400mm **35kg**  
 CAJÓN GRANDE (x1)  
**F** 233mm x 265mm x 400mm **35kg**

Módulo 2: **14297** 72,50€

Módulo 3: **14298** 44,50€

Módulo 1: **14296** 99,00€



Módulo 4: **14299** 72,50€





# CARRO DE HERRAMIENTAS 7 CAJONES - XL

**53912**  
1.280,00€  
92 Kg 1 4  
CON DOTACIÓN

**53869**  
990,00€  
74,50 Kg 1 4  
VACÍO

**53913**  
1.280,00€  
92 Kg 1 4  
CON DOTACIÓN

**53870**  
990,00€  
74,50 Kg 1 4  
VACÍO

192 PCS

# XL

ACCESORIOS Y RECAMBIOS  
página 79

CON MÓDULOS EVA:



14296

15122



14297

15161



14298

15155



14299

13884

ARMARIOS

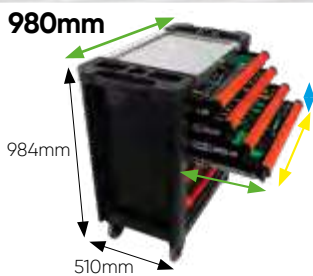

MEDIDAS INTERIOR

CAJONES PEQUEÑOS (x5)

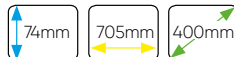

25kg

CAJONES GRANDES (x2)

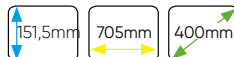

35kg



SISTEMA DE CIERRE INTERNO DE SEGURIDAD



PESTAÑA DE CIERRE INDIVIDUAL POR CAJÓN

RUEDAS EXTRA FUERTES PARA UN MANEJO SEGURO: RUEDAS GIRATORIAS, 2 CON FRENO



SUPERFICIE DE TRABAJO DE ACERO INOXIDABLE

DOBLE EMPUÑADURA DE AGARRE ERGONÓMICA, SUAVE Y ANTIDESLIZANTE.

LATERALES PERFORADOS PARA AÑADIR ACCESORIOS

# CARRO DE HERRAMIENTAS 7 CAJONES

**53763**

890,00€



**53765**

890,00€



**53900**

890,00€



172  
PCS

350Kg

**53764**

680,00€



**53766**

680,00€



**53901**

680,00€



ARMARIOS

## ALTA CALIDAD

- ✓ RESISTENTE A GRANDES CARGAS
- ✓ LIGERO Y FÁCIL DE TRANSPORTAR
- ✓ HERRAMIENTAS BIEN ORDENADAS EN MÓDULOS
- ✓ CONSTRUCCIÓN ROBUSTA Y DURADERA



LATERALES PERFORADOS PARA PERMITIR AL USUARIO AÑADIR UNA GRAN CANTIDAD DE ACCESORIOS



SISTEMA DE CIERRE CENTRALIZADO



PESTAÑA DE CIERRE INDIVIDUAL PORCAJÓN

CON MÓDULOS EVA:  
SET DE 4 MÓDULOS EVA  
ACABADO EN FIBRA DE CARBONO

**53708**

292,00€

RUEDAS DE 5":  
2 FIJAS Y  
2 GIRATORIAS, UNA  
CON FRENO

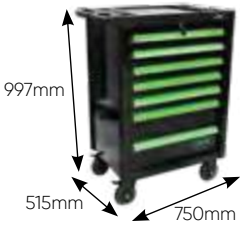

CAJÓN PEQUEÑO (x6)

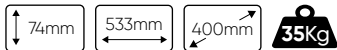

CAJÓN GRANDE (x1)



CAPACIDAD DE CARGA DEL CAJÓN: 40KG.  
CAPACIDAD BANDEJA SUPERIOR DE PLÁSTICO: 125KG.

Módulo 1: **14296** 99,00€



Módulo 2: **14297** 72,50€



Módulo 3: **14298** 44,50€



Módulo 4: **14299** 72,50€





# CARRO DE HERRAMIENTAS 7 CAJONES

<b>53661</b> 890,00€	56,5 Kg	1	2	CON DOTACION	<b>53686</b> 890,00€	56,5 Kg	1	2	CON DOTACION	<b>53767</b> 890,00€	74,30 Kg	1	4	CON DOTACION	<b>53904</b> 890,00€	72 Kg	1	4	CON DOTACION	<b>172 PCS</b>
-------------------------	---------	---	---	--------------	-------------------------	---------	---	---	--------------	-------------------------	----------	---	---	--------------	-------------------------	-------	---	---	--------------	----------------

300 Kg

<b>53761</b> 680,00€	56,3 Kg	1	2	VACIO	<b>53762</b> 680,00€	56,3 Kg	1	2	VACIO	<b>53768</b> 680,00€	59 Kg	1	4	VACIO
-------------------------	---------	---	---	-------	-------------------------	---------	---	---	-------	-------------------------	-------	---	---	-------

## ACCESORIOS Y RECAMBIOS

página 79



PESTAÑA DE CIERRE INDIVIDUAL POR CAJÓN



SISTEMA DE CIERRE CENTRALIZADO



2 RUEDAS GIRATORIAS

CAJÓN PEQUEÑO (x5)  
74mm x 533mm x 400mm 35Kg

CAJÓN GRANDE (x2)  
151,5mm x 533mm x 400mm 35Kg

CAPACIDAD DE CARGA DEL CAJÓN: 35KG.  
CAPACIDAD TOTAL DE CARGA: 300KG.

**53708** CON MÓDULOS EVA:  
292,00€ SET DE 4 MÓDULOS EVA ACABADO EN FIBRA DE CARBONO

Módulo 1: **14296** 99,00€



Módulo 2: **14297** 72,50€



Módulo 3: **14298** 44,50€



Módulo 4: **14299** 72,50€



# CARRO DE HERRAMIENTAS 7 CAJONES ESPECIAL KIT DE CALADO

**53951**

1.794,00€

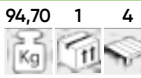

**53952**

1.794,00€

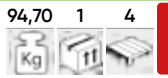

**53775**

1.108,50€

SET DE 6 MÓDULOS DE KITS DE CALADO

diesel gasolina

**ACCESORIOS Y RECAMBIOS**  
página 79

ARMARIOS

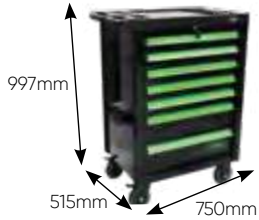

Módulo 1: **53769** 170,00€

RENAULT / NISSAN / OPEL / VOLVO



Módulo 2: **53770** 190,50€

FORD / SEAT / VOLKSWAGEN / MAZDA / VOLVO



Módulo 3: **53771** 154,50€

FIAT / FORD / CITROËN / PEUGEOT



Módulo 5: **53773** 293,00€

FIAT / ALFA / LANCIA / OPEL / SUZUKI / FORD



Módulo 6: **53774** 189,50€

OPEL / CHEVROLET / SAAB / FIAT / LANCIA / SUZUKI / FORD



Módulo 4: **53772** 211,00€

FORD / VAG / MAZDA / VOLVO







Escoge el color de carro que quieras y llénalo de

## HERRAMIENTAS PARA CHAPISTA

## HERRAMIENTAS PARA MANTENIMIENTO

### CARRO DE HERRAMIENTAS 7 CAJONES ESPECIAL CHAPISTA

<b>53577</b> 990,00€	74,5 Kg 1 2	<b>53579</b> 990,00€	74,5 Kg 1 2	<b>53580</b> 990,00€	74,5 Kg 1 2	<b>53509</b> 482,00€	SET DE 6 MÓDULOS PARA CARRO DE CHAPISTA:	<b>256 PCS</b>
-------------------------	-------------	-------------------------	-------------	-------------------------	-------------	-------------------------	--	----------------

Módulo 1:

**14059**  
62,00€



PALANCAS DE NYLON

**15 PCS**

Módulo 2:

**14060**  
65,00€

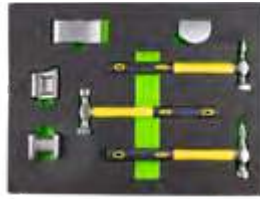

MARTILLOS ESPECIAL PARA CHAPA

**7 PCS**

Módulo 3:

**14061**  
93,00€



PINZAS DE PRESIÓN CON MORDAZAS

**7 PCS**

Módulo 4:

**14062**  
100,00€



VENTOSAS Y HERAMIENTAS PARA SUSTITUCIÓN DE LUNAS

**10 PCS**

Módulo 5:

**14063**  
118,50€



REPARADOR DE ABOLLADURAS

**32 PCS**

Módulo 6:

**14064**  
39,50€



ÚTILES PARA ABRIR COCHES

**11 PCS**

### CARRO DE HERRAMIENTAS 7 CAJONES ESPECIAL MANTENIMIENTO

<b>53514</b> 990,00€	74,5 Kg 1 2	<b>53556</b> 990,00€	74,5 Kg 1 2	<b>53557</b> 990,00€	74,5 Kg 1 2	<b>256 PCS</b>
-------------------------	-------------	-------------------------	-------------	-------------------------	-------------	----------------

**53469**  
613,00€

SET DE 5 MÓDULOS PARA CARRO DE CAMBIO DE ACEITE:



Módulo 1:

**14141**  
104,50€



EXTRACTORES DE FILTROS DE ACEITE

**22 PCS**

Módulo 2:

**14142**  
101,50€

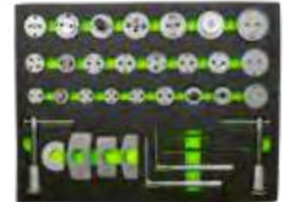

REPOSICIONADOR DE FRENOS

**34 PCS**

Módulo 3:

**14143**  
124,00€



TAPONES CÁRTER Y EXTRACTORES DE FILTRO DE ACEITE AJUSTABLES

**86 PCS**

Módulo 4:

**14144**  
304,00€



PISTOLA Y VASOS DE IMPACTO

**6 PCS**

Módulo 5:

**53116**  
99,00€



108 PIEZAS CON VASOS HEX.

**108 PCS**

# CARRO DE 7 CAJONES CON GUÍA TELESCÓPICA CON Y SIN DOTACIÓN

**52393**

1.180,00€

69,5

1

2

CON DOTACIÓN

1

2

CON DOTACIÓN

1

**52172**

780,00€

58

1

2

VACÍO

- Ruedas sin montar.

- Espesor de metal:  
Cajón: 0,8mm  
Cuadro: 1mm

**179**  
PCS



CON TAPETE DE GOMA ANTIDESLIZANTE

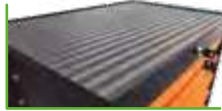

CIERRE CON LLAVE



RUEDAS CON FRENOS



125x50mm



MEDIDAS INTERIOR

CAJONES PEQUEÑOS (x5)

70mm x 563mm x 395mm

**35kg**

CAJONES GRANDES (x2)

148mm x 563mm x 395mm

**35kg**

CON MÓDULOS EVA:

**53708**

292,00€

SET DE 4 MÓDULOS EVA ACABADO EN FIBRA DE CARBONO

Módulo 1: **14296** 99,00€



Módulo 2: **14297** 72,50€



Módulo 3: **14298** 44,50€

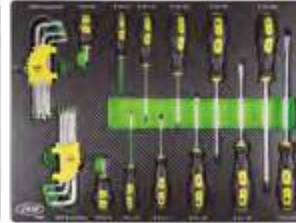

Módulo 4: **14299** 72,50€



# CARRO DE HERRAMIENTAS 9 CAJONES

**53867**

1.095,00€

73,45

1

4

ACCESORIOS Y RECAMBIOS página 79

CON SEPARADORES



ORGANIZACIÓN LIBRE

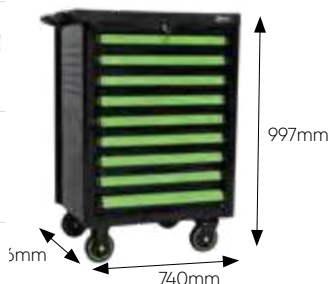

MEDIDAS CAJÓN

75mm x 533mm x 400mm

**35kg**

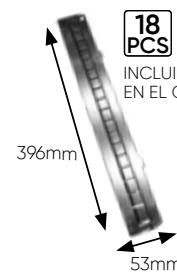

**18**  
PCS

INCLUIDAS EN EL CARRO

**15076**

3,50€

0,30 50



**21**  
PCS

INCLUIDAS EN EL CARRO

**15073**

1,00€

0,05 200

TAMBIÉN TE PUEDE INTERESAR...

REF.	mm		€
15070	67x53mm	0,05 200	0,50€
15071	103x53mm	0,05 200	0,60€
15072	138x53mm	0,05 200	0,70€
15074	210x53mm	0,10 200	1,00€
15075	280x53mm	0,10 200	1,20€



# CARRO DE HERRAMIENTAS CON 1 CAJÓN

53866

615,00€



350Kg

ACCESORIOS  
Y RECAMBIOS  
página 79



BANDEJA SEPARADOR AJUSTABLE



SISTEMA DE CIERRE CENTRALIZADO

SUPERFICIE DE GOMA ANTIDESLIZANTE

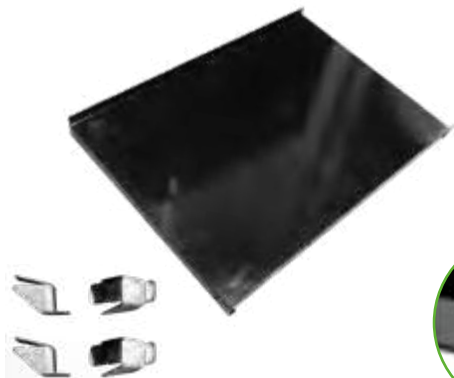

MEDIDAS CAJÓN

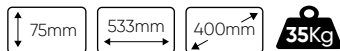

35Kg

## MÓDULOS DE HERRAMIENTAS

### JUEGO DE VASOS PARA TAPONES CÁRTER

15084

46,50€



MÓDULO ACABADO EN FIBRA DE CARBONO

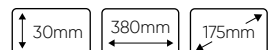

TE PUEDE INTERESAR...

15018

46,00€



También apto para recogedores de aceite 53873 y 53874.

CONTIENE

	x2	5/16", 3/8"
	x7	7, 8, 10, 11, 12, 13, 14mm
	x1	10mm
	x1	10mm
	x7	8, 9, 10, 12, 13, 14, 17mm
	x1	T45
	x1	M16
	x1	200mm
	x1	150mm



# MÓDULOS DE HERRAMIENTAS

## CONJUNTO DE 6 MÓDULOS DE KITS DE CALADO

**53775**

38,20 1 12

1.108,50€



**diesel** **gasolina**

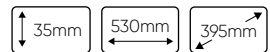

**53769**

170,00€



5,90 3 36



RENAULT / NISSAN / OPEL / VOLVO

**53770**

190,50€



6,15 3 36



FORD / SEAT / VOLKSWAGEN / MAZDA / VOLVO

**53771**

154,50€



4,05 3 36



FIAT / FORD / CITROËN / PEUGEOT

**53772**

211,00€



6,40 3 36



FORD / VAG / MAZDA / VOLVO

**53773**

293,00€



6,60 3 36



FIAT / ALFA / LANCIA / OPEL / SUZUKI / FORD

**53774**

189,50€



6,95 3 36



OPEL / CHEVROLET / SAAB / FIAT / LANCIA / SUZUKI / FORD

+ INFORMACIÓN DE CADA MÓDULO EN **KITS DE CALADO**, pág. 240

## SET DE 4 MÓDULOS EVA ACABADO EN FIBRA DE CARBONO

**53708**

15,20 1 20

292,00€

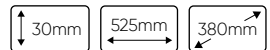

**14296**

99,00€

6,05  
4  
80



**14297**

72,50€

3,30  
4  
80



**14298**

44,50€

2,10  
4  
80

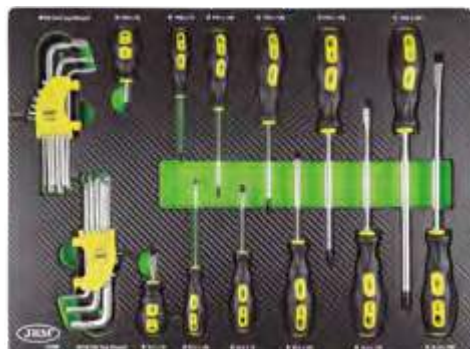

**14299**

72,50€

3,25  
4  
96







**15122**  
69,00€

1,6	10	220
Kg		



8, 9, 10, 11, 12, 13, 14, 15, 16, 17, 18, 19mm



**15155**  
56,00€

2,03	10	220
Kg		

8, 10, 11, 12, 13, 14, 15, 16, 17, 18, 19mm



**15156**  
58,00€

1,8	10	220
Kg		

21x23, 24x27, 25x28, 30x32 mm



**15157**  
42,00€

0,8	10	220
Kg		

6x8, 10x12, 13x14, 15x17, 19x21, 22x24 mm

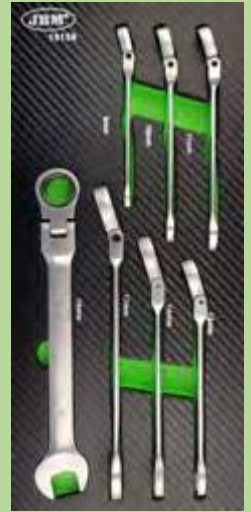

**15158**  
50,00€

1,05	10	220
Kg		

8, 10, 11, 13, 14, 17, 19 mm



**15159**  
39,00€

0,69	10	220
Kg		

8x10, 11x13, 14x15, 17x19, 20x22 mm



**15160**  
39,00€

0,73	10	220
Kg		

8x9, 10x11, 12x13, 14x15, 16x17, 18x19 mm



**15161**  
56,00€

1,55	10	220
Kg		

27, 29, 30, 32 mm



**15316**  
50,00€

0,76	10	220
Kg		

8, 9, 10, 11, 12, 13, 14, 15, 16, 17, 18, 19mm



**15454**  
33,00€

0,95	10	220
Kg		

8"



**15514**  
11,50€

0,05	10	220
Kg		



**15162**  
25,50€

0,5	10	220
Kg		

Medidas:  
SL 3x75mm  
SL 4x100mm  
SL 5.5x125mm  
SL 6.5x150mm  
PH 0x75mm  
PH 1x80mm  
PH 2x100mm  
Comprobador de tensión, 140 mm  
SL 0.5 x 3.0 mm



MÓDULOS DE HERRAMIENTAS



**53620**

87,50€

3,52 4 112



525x30x380mm



**11996**

44,50€

2,06 10 200



6x7mm - 20x22mm +  
24x27mm + 30x32mm



**11994**

33,00€

1/4"



**11997**

35,00€

1,22 10 300



6x7mm - 18x19mm +  
20x22mm



**11998**

48,50€

1,87 10 200



6x7mm - 18x19mm -  
20x22mm



**51378**

21,00€

0,81 10 30 240



⊕ PH4x200, PH3x150,  
PH2x100, PH2x38, PH1x80,  
PH0x120, PH1x100mm



**53943**

18,50€

0,80 10 200



⊕ PH4x200, PH3x150,  
PH2x100, PH2x38  
PH1x80, PH0x120,  
PH1x100



**53944**

18,50€

0,80 10 220



⊖ SL9x200, SL4x125,  
SL5x100, SL5x80,  
SL6x38, SL6x100,  
SL8x150mm



**53945**

18,50€

0,60 10 220



⊖ T8x75, T9x75,  
T10x75, T15x75,  
T20x75, T25x100,  
T27x100



**14114**

21,85€

0,93 10 360



**13884**

12,50€

0,1 10 300



**13923**

9,00€

0,05 30



**13667**

18,00€

0,83 10 360



**13668**

19,00€

0,61 10 300



**13669**

18,00€

0,61 10 360





# MÓDULOS PLÁSTICO 175x30x380mm



**10731**  
18,00€

Kg 0,92  
10  
220



**10732**  
18,50€

Kg 0,7  
10  
220



**10733**  
17,50€

Kg 0,69  
10  
220



**10727**  
23,00€

Kg 0,4  
10  
220

1,7, 2,4,  
2,5, 3cm



**10735**  
20,00€

Kg 0,92  
10  
220

ACCESORIOS

**ACCESORIOS** PARA CARROS REF. 53514, 53556, 53557, 53577, 53579, 53580, 53661, 53686, 53761, 53762, 53763, 53764, 53765, 53766, 53767, 53768, 53866, 53867, 53868, 53869, 53870, 53900, 53901, 53904, 53912, 53913, 53939, 53951, 53952

## PORTA SPRAYS Y PORTA ACCESORIOS

**15313**

14,00€

Kg 0,8  
20



## PORTA SPRAYS

**14354**

14,00€

Kg 0,60  
1  
160



## PORTABOBINA DE PAPEL

**15068**

18,00€

Kg 0,65  
25  
500



## PORTA ARCHIVADOR

**15069**

28,50€

Kg 1,65  
1  
80



**RECAMBIOS** PARA CARROS REF. 53661, 53686, 53763, 53764, 53765, 53766, 53867, 53868, 53869, 53870, 53900, 53901, 53904



14580, 15031,  
15034, 15038



15019



15032



14578



15029, 15030,  
15035, 15036, 15037,  
15042, 15050



15033



14783



15039, 15058,  
15065



15021, 15023,  
15025, 15040



15022, 15024,  
15026, 15041

REF.	DESCRIPCIÓN	1	2	3	€	53661	53686	53763	53764	53765	53766	53866	53867	53868	53869	53870	53900	53901	53904	
14578	Guía cajón grande	1,05	1	25	12,50€	X	X													X
14580	Tapa superior	2,60	3	39	40,50€	X	X													X
14783	Protector lateral derecho	0,25	1	50	5,50€	X	X													X
15019	Pestaña de cierre	0,05	1	100	6,00€			X		X		X	X	X	X	X	X			
15021	Rueda fija	0,65	1	10	12,50€			X	X			X	X	X	X					
15022	Rueda giratoria	0,95	1	8	15,00€			X	X			X	X	X	X					
15023	Rueda fija	0,65	1	10	12,50€					X	X					X				
15024	Rueda giratoria	0,95	1	8	15,00€					X	X					X				
15025	Rueda fija	0,65	1	10	12,50€													X	X	
15026	Rueda giratoria	0,95	1	8	15,00€													X	X	
15029	Tirador de cajón	0,28	1	50	8,00€			X	X			X	X	X						
15030	Tirador de cajón	0,30	1	50	8,00€					X	X									
15031	Tapa superior	2,15	1	2	8,00€			X	X	X	X	X	X					X	X	
15032	Guía cajón	1,05	1	9	16,00€			X	X	X	X	X	X	X	X	X	X	X	X	
15033	Tirador de cajón estrecho	0,30	1	50	6,00€									X						
15034	Tapa superior	-	-	-	56,50€									X						
15035	Tirador de cajón	0,36	1	20	8,50€										X					
15036	Tirador de cajón	0,36	1	20	8,50€											X				
15037	Tirador de cajón	-	-	-	8,00€													X	X	
15038	Tapa superior	-	-	-	34,50€										X	X				
15039	Protector lateral	0,36	1	25	7,50€			X		X		X	X	X	X	X	X			
15040	Rueda fija	0,66	1	10	12,50€															
15041	Rueda giratoria	0,98	1	8	15,00€															X
15042	Tirador de cajón	0,10	1	-	7,50€															X
15050	Tirador de cajón	0,10	1	50	9,50€	X	X													
15058	Protector lateral	-	-	-	7,50€									X						
15065	Protector lateral	0,55	1	12	6,50€										X	X				

COMPATIBILIDAD

# ARMARIO DE TRABAJO MULTIMEDIA CON RUEDAS

**51456**

725,00€

42,5 1 2  
Kg tfl

- Ruedas sin montar.

SET DE 4 RUEDAS PARA ARMARIO REF. 51456

Ø12cm

2 Ruedas con freno + 2 simples

**11313**

53,50€

4,11 1 54  
Kg tfl



Bandejas ajustables cada 70mm

220mm

1165mm

575mm

EXTERIOR

1165mm 675mm 458mm

CAJÓN SUPERIOR

70mm 570mm 425mm

ARMARIO INFERIOR

890mm 670mm 455mm

## CARRO CON 3 BANDEJAS

**51576**

178,00€

15 1 22  
Kg tfl

- Ruedas sin montar.



100kg

## CARRO CON 3 BANDEJAS MAXI

**52373**

268,00€

24,7 1 10  
Kg tfl

- Ruedas sin montar.

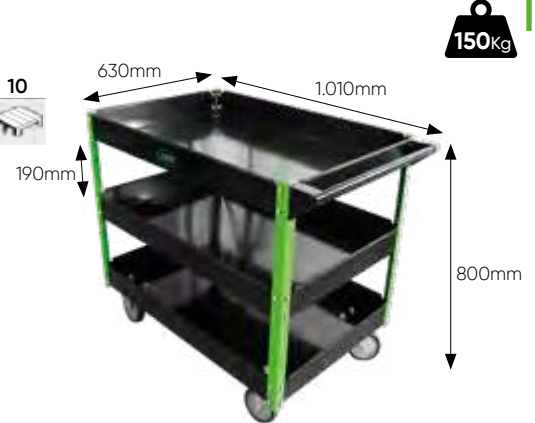

150kg

## PANEL PARA HERRAMIENTAS

**52419**

108,00€

7,49 1 37  
Kg tfl

1.000 x 600mm

**52420**

135,00€

10,80 1 35  
Kg tfl

1.500 x 600mm

**52421**

196,50€

14 1 38  
Kg tfl

2.000 x 600mm

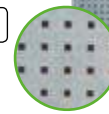

ENGANCHE CUADRADO

## GANCHOS

### ESPECIAL LLAVES

**51653**

9,80€

0,28 10 840  
Kg tfl

PARA REF.:  
52419, 52420, 52421



### ESPECIAL DESTORNILLADORES

**51657**

9,00€

0,3 10 50 1.000  
Kg tfl

PARA REF.:  
52419, 52420, 52421



PARA REF. 52419, 52420, 52421

GANCHO PICO CERRADO

95mm 51654 0,09 10 100  
5,00€ Kg tfl

31mm GANCHO 2 PICOS CORTOS 51655 0,07 10 100  
6,00€ Kg tfl

92mm GANCHO 2 PICOS LARGOS 51658 0,05 10 100  
5,50€ Kg tfl

91mm GANCHO PICO LARGO 51656 0,07 10 100  
6,00€ Kg tfl

200mm GANCHO DOS PICOS EXTRA LARGOS 52634 0,14 10 100  
6,00€ Kg tfl

95mm GANCHO 2 PICOS LARGOS 51422 0,05 100  
6,00€ Kg tfl

200mm GANCHO PICO CERRADO EXTRA LARGO 52635 0,14 10 100  
5,50€ Kg tfl

PARA REF. 51428, 51430, 52705, 52706, 52707, 52708, 52709

90mm GANCHO 1 PICO LARGO 51419 0,03 100  
4,00€ Kg tfl

30mm GANCHO 1 PICO CORTO FONDO 51975 0,03 100  
2,00€ Kg tfl

75mm GANCHO 2 PICOS LARGOS 51976 0,03 100  
4,00€ Kg tfl

PARA REF. 51035, 53661, 53686, 53761, 53762, 53767, 53768, 53904

95mm GANCHO 2 PICOS LARGOS 51422 0,05 100  
6,00€ Kg tfl

EQUIPAMIENTO DE TALLER



## MESA DE TRABAJO CON PANEL FRONTAL

51035

799,00€

86,5

1

5



EQUIPAMIENTO DE TALLER

## MESA DE TRABAJO DE 3 CAJONES

51738

850,00€

81,5

1

5



MEDIDAS CAJÓN

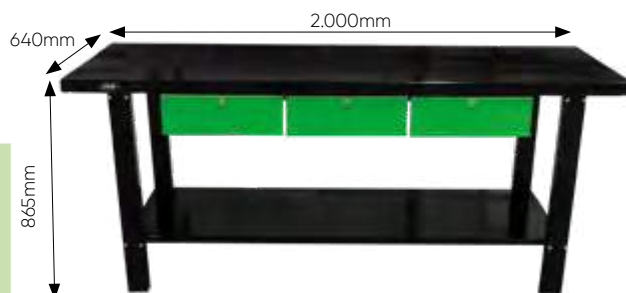

15144

30,00€

ALFOMBRA DE GOMA

2,5

1



## MESA DE TRABAJO CON 2 CAJONES

51737

699,00€

65,5

1

5



## MESA DE TRABAJO DE 1 CAJÓN

53674

480,00€

50

1

5

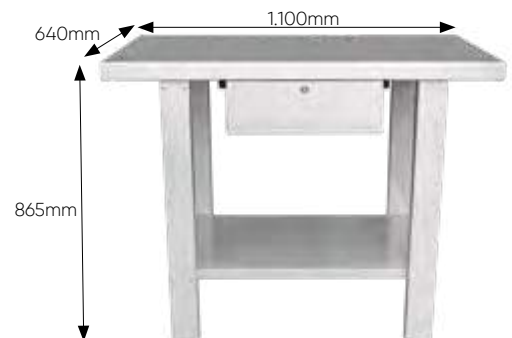

15145

20,45€

ALFOMBRA DE GOMA

1,9

1



- Cajón:  
Capacidad máxima: 50kg  
Medidas: 348 x 441 x 142mm

15146

16,15€

ALFOMBRA DE GOMA

1,35

1



- Cajón:  
Capacidad máxima: 50Kg  
Medidas: 348x441x142mm

# CARRO MODULAR

53672

440,00€



90 PCS

EQUIPAMIENTO DE TALLER



3 COMPARTIMENTOS DESMONTABLES Y SEPARABLES

PUEDEN SER UTILIZADOS INDIVIDUALMENTE O CONJUNTAMENTE



ASA SUPERIOR EN CADA MÓDULO PARA FACILITAR EL TRANSPORTE INDIVIDUAL



BLOQUEABLE CON CANDADO (NO INCLUIDO)

## 3 MÓDULOS INDEPENDIENTES EQUIPADOS CON:

1



CAJA DE HERRAMIENTAS EN MÓDULOS EVA + BANDEJA SUPERIOR EXTRAIBLE

- Herramientas de 1/4": 13x vasos hexagonales: 4 - 4,5 - 5 - 5,5 - 6 - 7 - 8 - 9 - 10 - 11 - 12 - 13 - 14mm 1x Articulación universal 1x Mango corredizo (T) 1x Mango destornillador 1x Barra de extensión de 50mm 1x Barra de extensión de 100mm 1x Destornillador imantado 1x Carraca de 72 dientes
- Herramientas de 1/2": 10x vasos hexagonales: 8 - 10 - 11 - 12 - 13 - 14 - 16 - 17 - 19 - 21 - 22mm 1x Articulación universal 1x Barra de extensión de 300mm 1x Barra de extensión de 125mm 1x Carraca de 72 dientes- 1x Set de 8 llaves allen de 1,5\*8mm 1x Metro: 3m 1x Set de 32 puntas de 1/4"

2

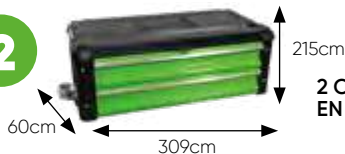

2 CAJONES CON HERRAMIENTAS EN MÓDULOS EVA



- 1x Alicata de corte diagonal: 180mm
- 1x Alicata universal: 180mm
- 1x Alicata de punta alargada: 160mm
- 1x Alicata plano: 160mm
- 1x Destornillador: PH2x125mm
- 1x Destornillador: PH1x100mm
- 1x Destornillador plano: 6x150mm
- 1x Destornillador plano: 5x100mm

- 9x Llaves combinadas: 8, 9, 10, 11, 12, 13, 14, 17, 19mm
- 1x Llave inglesa 250mm
- 1x Martillo de peña 300g
- 1x Alicata ajustable 250mm
- 1x Navaja

3



Contenedor para herramientas más grandes

14327

SET DE 3 MÓDULOS EVA CARBONO

177,00€





# CAJA DE HERRAMIENTAS DE HIERRO 64 PCS

**53565**

258,00€

16,50 1 24



CINCADO

CrV

64  
PCS

290mm

495mm

200mm

INCLUYE:



## CONTIENE

	1/2" x18	10, 11, 12, 13, 14, 15, 16, 17, 18, 19, 20, 21, 22, 23, 24, 27, 30, 32mm		1/2" x1	255mm
	72			x1	457mm
	x1	1/2"		x18	6, 7, 8, 9, 10, 11, 12, 13, 14, 15, 16, 17, 18, 19, 20, 21, 22, 24mm
	1/2" x3	76, 127, 254mm		x9	15, 2, 2.5, 3, 4, 5, 6, 8, 10mm

	x3	PH1x100mm, PH2x150mm, PH3x200mm		x3	SL5x100mm, SL6x150mm, SL8x200mm
	x1	250mm		x1	180mm
	x1	200mm		x1	180mm



DESPIECE DISPONIBLE

## CAJA PARA HERRAMIENTAS CON 5 COMPARTIMENTOS

**51574**

58,00€

4,3 1 35

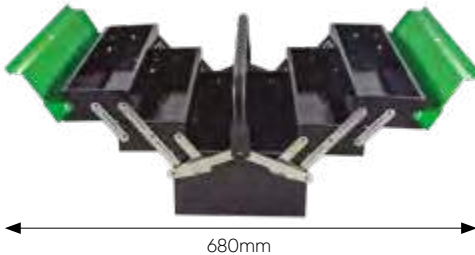

## CAJA PARA HERRAMIENTAS XL

**53222**

72,50€

6,25 1 25



XL



## CAJA PARA HERRAMIENTAS CON 3 CAJONES FRONTALES + COMPARTIMENO SUPERIOR

**51600**

109,00€

7,69 1 18

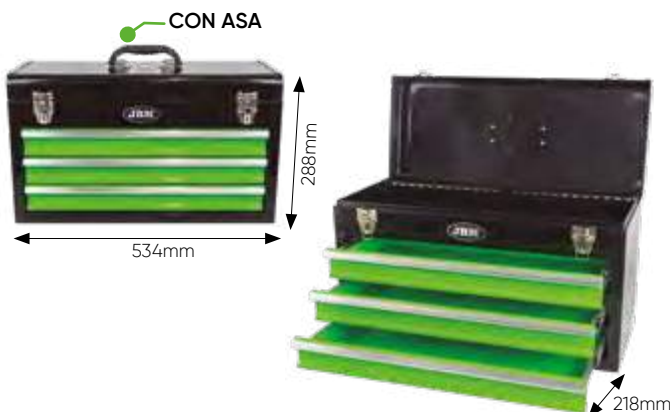

CON ASA

## CAJA PARA HERRAMIENTAS CON 6 CAJONES + COMPARTIMENO SUPERIOR

**51575**

350,50€

19,75 1 9



- Cajones grandes: 570mm ancho  
- Cajones pequeños: 180mm ancho

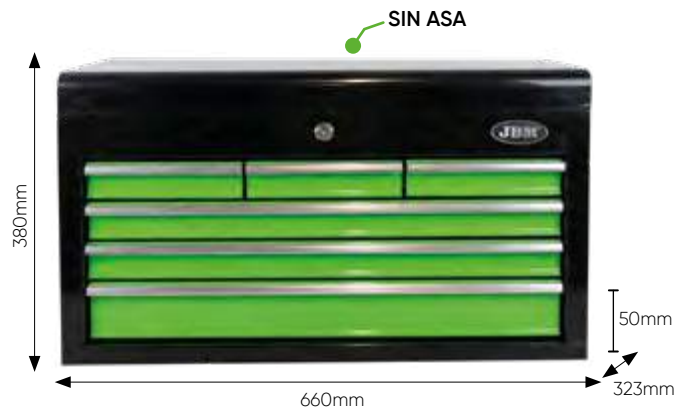

SIN ASA

## ASIENTO NIVELABLE NEUMÁTICO

50843

88,00€



Ø 295mm

520mm

135KG

520mm  
390mm



Ø 380mm

## TABURETE DE ACERO

50844

76,00€



115 KG



## CAMILLA PLÁSTICA

52148

89,00€



150KG

- Plástico alta densidad.
- Ruedas reforzadas de goma.
- Muy resistente.



## CAMILLA PLEGABLE METÁLICA

50808

84,00€



150KG



## CAMILLA PLEGABLE CONVERTIBLE

53211

79,00€

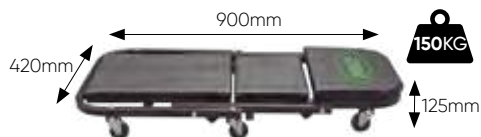

150KG



120KG

52542

109,00€



DE ACERO Y  
ASIENTOS DE PVC



7 RUEDAS



135KG

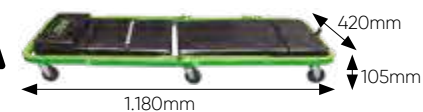

115KG





# MOCHILA PARA HERRAMIENTAS ELÉCTRICAS

PEQUEÑA

**53702**

24,50€

1 5 180



MEDIANA

**53703**

32,00€

1,40 5 120



GRANDE

**53704**

36,00€

1,65 5 120



SEPARADOR INTERNO



BOLSILLOS DELANTEROS, POSTERIORES Y LATERALES



CORREA PARA EL HOMBRO

# MOCHILA PARA HERRAMIENTAS

**53258**

75,40€

2,6 2 32



- No incluye herramientas.



CON SOBRE INTERIOR



# MALETA DE HERRAMIENTAS

**53253**

98,00€

4,5 2 12



- 600D Polyester.  
- No incluye herramientas.



# MOCHILA PARA HERRAMIENTAS ELÉCTRICAS - GRANDE

53782

14,00€



25Kg/13L



EQUIPAMIENTO DE TALLER

## TORNILLO DE BANCO 150MM RÁPIDO

52871

247,50€



6"



APERTURA INMEDIATA  
MEDIANTE PALANCA +  
BASE ROTATIVA



## TORNILLO DE BANCO BASE ROTATIVA

53031

68,00€



53032

129,00€

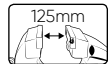
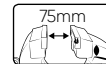
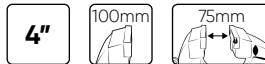

53031



53032

## TORNILLO DE BANCO

51570

182,50€



4"

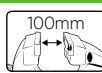

## TORNILLO DE BANCO

52869

51,50€



52870

99,00€

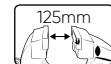
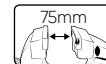
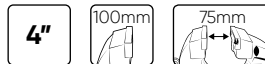

## YUNQUES PROFESIONALES

52308

630,00€



52309

995,00€



ACERO



ACERO



LLAVES DE IMPACTO 88



CARRACA / ATORNILLADOR DE IMPACTO 91



TALADRO DE IMPACTO / MARTILLO DE ROTACIÓN 92



PULIDORA / AMOLADORA 94



SIERRAS 95



ASPIRADOR / INFLADOR 98



ILUMINACIÓN LED 105



MOTOSIERRA / CORTASETOS 103



SOPLADOR / PULVERIZADOR INDUSTRIAL 102



BATERÍAS / CARGADORES 107



ACCESORIOS 108



MOCHILAS 112



# ELÉCTRICA A BATERÍA CON MOTOR BRUSHLESS (SIN ESCOBILLAS)



**SERIE327**

# Herramientas eléctricas sin cable, para un uso más cómodo y sin límites

Con motor **BRUSHLESS (sin escobillas)**:  
mayor eficiencia, mayor vida útil,  
más velocidad y menos ruido.

CE RoHS OGS

## LLAVE DE IMPACTO A BATERÍA 1/2" BRUSHLESS

1000Nm

60018

2,85

6

72

Batería no incluida.

305,50€



Esta herramienta ha sido diseñada para **tensar, aflojar y desenroscar tornillos**, así como taladrar en **madera, metal, cerámica y plástico**.



BRUSHLESS MOTOR 20V 1000 Nm 1/2" 0-2300IPM

① 0-900 RPM ② 0-1600 RPM ③ 0-1900 RPM LED

EJE DE SALIDA

14675 17,00€

INTERRUPTOR

14677 9,00€

CAPARAZÓN DEL CABEZAL

14679 9,50€

PLACA BASE + ESTATOR

14648 105,15€

CONJUNTO BLOQUE DE IMPACTO

14676 36,50€

PLACA BASE

14678 86,00€

ROTOR

14769 37,75€

5 MARCHAS DISTINTAS



¿Quieres ver cómo funciona?



- Contiene:  
Empuñadura ergonómica.  
Selector de la dirección de rotación.  
Gatillo.  
Luz de trabajo LED.  
Gancho para cinturón.





## LLAVE DE IMPACTO A BATERÍA 1/2" BRUSHLESS

**1200Nm**

**60036**

**305,50€**



3,20

Kg

4

fl

144

fl

Batería no incluida.

Esta herramienta ha sido diseñada para **tensar, aflojar y desenroscar tornillos**, así como taladrar en **madera, metal, cerámica y plástico**.



EJE DE SALIDA

**14675** 17,00€

INTERRUPTOR

**14677** 9,00€

CAPARAZÓN DEL CABEZAL

**14679** 9,50€

PLACA BASE + ESTATOR

**14648** 105,15€

CONJUNTO BLOQUE DE IMPACTO

**14676** 36,50€

PLACA BASE

**14678** 86,00€

ROTOR

**14679** 37,75€

5 MARCHAS DISTINTAS



¿Quieres ver cómo funciona?



- Contiene:  
Empuñadura ergonómica.  
Selector de la dirección de rotación.  
Gatillo.  
Luz de trabajo LED.  
Gancho para cinturón.



Utilízalas con las baterías JBM: una única batería apta para todas las herramientas

BATERÍAS LI-ION

2.0Ah



**60012**

4.0Ah



**60013**

6.0Ah



**60015**

CARGADORES



**4A**  
**60016**



**CARGA RÁPIDA**  
**6A**  
**60017**

IMPACTO



## LLAVE DE IMPACTO A BATERÍA 3/4" BRUSHLESS

**1550Nm**

**60034**  
320,00€

3,20 4 144  
Kg l

Batería no incluida.

Esta herramienta ha sido diseñada para **tensar, aflojar y desenroscar tornillos**, así como taladrar en **madera, metal, cerámica y plástico**.

**BRUSHLESS MOTOR**

**20V** 1550 Nm **3/4"**

① 0-900 RPM    ② 0-1600 RPM    ③ 0-1900 RPM

EJE DE SALIDA  
**14675** 17,00€

INTERRUPTOR  
**14677** 9,00€

CAPARAZÓN DEL CABEZAL  
**14679** 9,50€

CONJUNTO BLOQUE DE IMPACTO  
**14676** 36,50€

PLACA BASE  
**14678** 86,00€

ROTOR  
**14679** 37,75€

PLACA BASE + ESTATOR  
**14648** 105,15€

5 MARCHAS DISTINTAS



¿Quieres ver cómo funciona?



- Contiene: Empuñadura ergonómica.
- Selector de la dirección de rotación.
- Gatillo.
- Luz de trabajo LED.
- Gancho para cinturón.





## CARRACA A BATERÍA DE 1/2" BRUSHLESS

**60024**  
189,50€

1,90 5 150  
Kg S.S. l

ESTA REFERENCIA INCLUYE  
X1 BATERÍA Y X1 CARGADOR

Esta herramienta está diseñada para **apretar y aflojar tornillos en espacios reducidos.**



**12V**

80 Nm

**1/2"**

0-175 RPM

LED



**2.0AH**  
60min +/-10min

CE RoHS

INCLUYE:

**CARGADOR 12V**  
PARA REF. 60026

**60025**  
28,50€

0,30 5 4  
Kg S.S. l



**BATERÍA LI-ION 2.0Ah**  
**SAMSUNG**  
PARA REF. 60024

**60026**  
33,00€

0,20 8 5  
Kg S.S. l

## ATORNILLADOR DE IMPACTO BRUSHLESS

**60005**  
132,00€

1,40 4 180  
Kg S.S. l

Batería no incluida.

Esta herramienta ha sido diseñada para **atornillar y apretar tornillos y tuercas de forma rápida**, especialmente al trabajar con **tornillos pasadores largos** y en **materiales robustos.**

Viene equipada con una **luz de trabajo LED** para mejorar la precisión durante su uso, un **porta puntas sin llave hexagonal de 1/4"** que permite una inserción y extracción rápida de las puntas, y un **gatillo que puede bloquearse** para prevenir un arranque accidental de la herramienta.



**BRUSHLESS MOTOR**

**20V**

200 Nm

LED

0-2800 RPM



**1/4"**

- Contiene:  
Luz led incorporada.  
Porta-puntas: hexagonal de 1/4".  
Interruptor de velocidad variable.  
Empuñadura ergonómica blanda.  
Caja de engranajes metálica.  
Gancho de transporte.



BLOQUE DE IMPACTO  
**14637** 15,50€

PLACA BASE  
**14642** 83,00€

EJE EN T  
**14638** 7,00€

PLACA BASE + ESTATOR  
**14765** 96,50€

INTERRUPTOR  
**14640** 8,00€

CABEZAL  
**15254** 12,50€

ROTOR  
**14641** 18,50€

**CONSUMIBLES:** Estuches de puntas de impacto

**53857**



**53858**



ver pág. 110

Utilízalas con las baterías JBM: una única batería apta para todas las herramientas

**BATERÍAS LI-ION**

2.0Ah



**60012**

4.0Ah



**60013**

6.0Ah



**60015**

**CARGADORES**



**4A**  
**60016**



**CARGA RÁPIDA**  
**6A**  
**60017**

## TALADRO PERCUTOR A BATERÍA 2 VELOCIDADES BRUSHLESS

Batería no incluida.  **60006**  
181,50€



PORTABROCAS:  
2-13MM (1/2")

- Contiene:  
Luz led incorporada.  
Interruptor de velocidad variable.  
Empuñadura ergonómica.  
Mango auxiliar.  
Gancho de transporte.

Esta herramienta ha sido diseñada para realizar **tareas de perforación en metal y madera**, tareas de **perforación con impacto**, en ladrillo, hormigón y piedra, así como para **tensar, aflojar y desenroscar tuercas y tornillos**.

Cuenta con un anillo de conversión funcional que permite configurar la herramienta entre el **modo taladro**, **taladro con impacto** o el modo **destornillador**, un anillo de ajuste que permite elegir **23 niveles de torque diferentes**, un **selector de velocidad**, y un **portabrocas sin llave de 1/2"** para una inserción y extracción rápida y eficaz de las brocas.



- PORTABROCAS  
**14643** 24,50€
- INTERRUPTOR  
**14644** 8,00€
- ROTOR  
**14645** 44,50€
- PLACA BASE + ESTATOR  
**14646** 109,50€
- MANGO AUXILIAR  
**14954** 14,50€



MANGO AUXILIAR



## CONSUMIBLES

(ver pág. 108-110)



### BROCAS PARA ALBAÑILERÍA

<b>53861</b>  3-10MM <b>8</b> PCS	<b>53860</b>  4-10MM <b>5</b> PCS	ACERO YG8 
--	--	--

### ESTUCHE DE BROCAS HELICOIDALES HSS-G 4341

<b>53852</b>  1-10MM <b>170</b> PCS	<b>53856</b>  1-13MM <b>25</b> PCS
--	---

### ESTUCHE DE PUNTAS DE IMPACTO CON ADAPTADOR RÁPIDO S2

<b>53857</b>  <b>49</b> PCS	<b>53858</b>  <b>21</b> PCS
--	---

### SIERRAS DE CORONA

<b>53859</b>  <b>8</b> PCS HSS M42 4-6TPI
---

## APLANADOR A BATERÍA BRUSHLESS

**60020**  Batería no incluida.  
175,00€

Esta herramienta está diseñada para realizar **tareas de carpintería**. Se puede utilizar para lograr un **acabado liso** en superficies de madera y realizar **tareas de rebaje**.

Esta herramienta tiene una **base de aleación de aluminio** para proporcionar una mayor precisión, un **sistema de colección del polvo** resultante de la operación, así como un **botón de bloqueo del gatillo** para evitar un arranque accidental de la herramienta.

- Contiene:  
1 perilla de ajuste de la profundidad de galce.  
1 guía paralela.  
3 perillas de fijación.  
1 llave de ajuste.  
1 tornillo.



- Características:  
Pomo de ajuste de la profundidad de corte.  
Base de aluminio.  
Interruptor de bloqueo del gatillo.  
Sistema de colectores de polvo.  
Empuñadura ergonómica.

- ESTATOR  
**14936** 27,50€
- GUÍA DE PROFUNDIDAD DE GALCE  
**14964** 8,00€
- GUÍA DE CORTE PARALELA  
**14965** 8,50€

- CORREA DE TRANSMISIÓN  
**14684** 3,00€
- INTERRUPTOR  
**14685** 5,00€
- PLACA BASE  
**14686** 72,50€
- ROTOR  
**14687** 35,00€





## MARTILLO DE ROTACIÓN A BATERÍA BRUSHLESS

**60023**

**212,00€**

3,10

6

120

Batería no incluida.



**BRUSHLESS MOTOR**

**20V** 4750BPM 2.2 J 1350 RPM

**WOOD** 28mm **CONCRETE** 22mm **STEEL** 13mm

**SDS**

PALANCA DE IMPULSO  
**14693 3,50€**

COJINETE OSCILANTE  
**14694 11,50€**

MARTILLO DE IMPACTO  
**14695 4,00€**

CILINDRO DE AIRE  
**14696 18,00€**

INTERRUPTOR  
**14697 8,00€**

ANILLO DE SELLADO  
**14698 1,00€**

ROTOR  
**14699 30,00€**

COJINETE #61  
**14700 2,50€**

PLACA BASE  
**14702 91,50€**

COJINETE #67  
**14701 2,50€**

CUBIERTA ANTIPOLVO  
**14967 5,50€**

MEDIDOR DE PROFUNDIDAD  
**14968 6,00€**

MANGO AUXILIAR  
**14969 9,00€**

- Contiene:  
1 cubierta antipolvo.  
1 medidor de profundidad.  
1 mango auxiliar.  
1 cincel en punta.  
1 cincel plano.  
3 brocas SDS: 8/10/12 x 150mm.  
Llave de ajuste.



### CONSUMIBLES: CINCELES Y BROCAS

(ver pág. 108)

**14837** EN PUNTA - 14x250mm

**14839** PLANO - 20x250mm

**14842** ADAPTADOR

**14841** PORTABROCAS

**53850** ESTUCHE SDS-PLUS

**14838** PLANO - 40x250mm

**14840** ACANALADO - 250mm



## LIJADORA ORBITAL BRUSHLESS

**60033**

**103,50€**

1

Kg

Batería no incluida.

Esta herramienta está diseñada para **lijar madera, hierro, plástico y materiales similares** utilizando el papel de lija adecuado. Esta lijadora es ajustable a tres velocidades diferentes, cuenta con una empuñadura confortable y lleva incorporada una bolsa de recogida de polvo.



**20V**

6000 RPM  
8500 RPM  
10000 RPM

0°C  
45°C  
x3 SPEED  
150mm

BOLSA RECOGE POLVO  
**15530 7,50€**

SOPORTE PARA LA BOLSA RECOGE POLVO  
**15531 5,00€**

PLACA BASE + ESTATOR + INTERRUPTOR  
**15532 98,00€**

RODAMIENTO  
**15533 4,50€**

RODAMIENTO  
**15534 4,50€**

BASE DE RODAMIENTO  
**15535 3,50€**

RODAMIENTO  
**15536 14,50€**

BLOQUE DE GOMA PARA FRENO  
**15537 6,00€**

BASE PLATO  
**15538 17,00€**

Utilízalas con las baterías JBM: una única batería apta para todas las herramientas

### BATERÍAS LI-ION

2.0Ah



**60012**

4.0Ah



**60013**

6.0Ah



**60015**

### CARGADORES



**4A 60016**



**CARGA RÁPIDA 6A 60017**



LIJAR/PULIR





## PULIDORA A BATERÍA BRUSHLESS

**60009** 2,22 4 80 Batería no incluida.  
**168,00€**



Esta herramienta ha sido diseñada para llevar a cabo procesos de acabado, tales como **pulir y redondear bordes y esquinas**, así como para conseguir un **correcto alisado de superficies** mediante su rueda y almohadilla de pulido.

La velocidad de la rueda es **ajustable a 9 niveles** distintos a través del selector de velocidad, y el **gatillo puede bloquearse** para un uso continuo de la herramienta o para su almacenamiento, previniendo así un arranque accidental.

- Contiene:  
 Almohadilla de pulido.  
 Mango auxiliar en D.  
 Llave Allen hexagonal.  
 Selector de velocidad de 9 fases: 800, 1000, 1200, 1400, 1600, 1800, 2000, 2200, 2400.  
 Empuñadura ergonómica.  
 Interruptor de seguridad.  
 Cierre de eje.



**BRUSHLESS MOTOR** **20V** **800-2400 RPM** **M14**  
**VELOCIDAD AJUSTABLE** **Ø 180mm**

ROTOR <b>14658</b> 45,00€	PLACA BASE + ESTATOR <b>14660</b> 83,00€	COJINETE #24 <b>14662</b> 2,50€	ALMOHADILLA DE PULIDO <b>14958</b> 22,00€
INTERRUPTOR <b>14659</b> 5,00€	ENGRANAJE <b>14661</b> 9,00€	COJINETE #26 <b>14663</b> 2,50€	MANGO AUXILIAR EN D <b>14959</b> 10,00€



## AMOLADORA A BATERÍA ANGULAR BRUSHLESS

Diámetro del disco: **115mm (4-1/2")**  
 1,85 6 168 **60008**  
**140,50€**

Diámetro del disco: **125mm**  
 1,95 6 162 **60028**  
**141,50€**

Batería no incluida.  
 Disco no incluido.

Esta amoladora angular ha sido diseñada para realizar todo tipo de tareas, tales como **cortar, pulir y lijar**.  
 - Tamaño del eje: **M14**.

**BRUSHLESS MOTOR** **20V** **8000 RPM** **M14**

ROTOR <b>14652</b> 45,00€	COJINETE #29 <b>14767</b> 3,00€
INTERRUPTOR <b>14653</b> 5,00€	MANGO AUXILIAR <b>14956</b> 8,00€
PLACA BASE + ESTATOR <b>14654</b> 99,50€	CUBIERTA PROTECTORA DE 115MM <b>14957</b> 7,50€
ENGRANAJE #13 <b>14655</b> 6,50€	CUBIERTA PROTECTORA DE 125MM <b>14808</b> 4,00€
PLACAS DE FIJACIÓN <b>14656</b> 5,00€	TUERCA DE SUJECIÓN RÁPIDA M14 <b>15014</b> 20,00€
COJINETE #23 <b>14657</b> 5,00€	
ENGRANAJE #22 <b>14766</b> 3,50€	



- Contiene:  
 Cubierta protectora.  
 Mango auxiliar.  
 Llave de ajuste.



### CONSUMIBLES

(ver pág.111)

**DISCOS DE CORTE PARA METAL / PARA ACERO INOXIDABLE**

**TUERCA DE SUJECIÓN RÁPIDA M14 PARA AMOLADORA ANGULAR**

**14893**

**14900**

**14893**

**T42**

**T41**





## SIERRA RECIPROCANTE BRUSHLESS

60019

179,50€

3,45

Kg

4

l

96

W

Batería no incluida.

Diseñada para realizar **tareas de corte en un gran variedad de materiales y ser usada para múltiples aplicaciones**. Su diseño permite **cambiar la hoja de corte de manera rápida y precisa**, gracias a su sistema de anclaje sin necesidad de utilizar herramientas, así como adaptar la velocidad de corte dependiendo de la operación que vaya a realizar.



- Incluye:  
Hoja para madera.  
Hoja para metal.



PALANCA RECIPROCANTE

14680 17,00€

PLACA BASE

14683 86,00€

PLACA BASE + ESTATOR

14681 107,50€

ROTOR

14770 40,00€

INTERRUPTOR

14682 9,00€

CONSUMIBLES REF. 60019

(ver pág.111)

14995

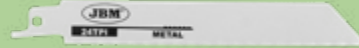

14994



CONSUMIBLES REF. 60010

(ver pág.111)

14993



14991



## SIERRA A BATERÍA DE CORTE VERTICAL BRUSHLESS

60010

169,50€

2,45

Kg

4

l

144

W

Batería no incluida.

Esta herramienta ha sido diseñada para realizar **tareas de corte en diferentes materiales**, tales como **madera, acero, plástico y metal**. Cuenta con **4 niveles de acción pendular**: 3 acciones de corte orbitales y una acción de corte recto, que permiten ajustar la velocidad de la hoja según la dureza del material a cortar.



20V

WOOD Max: 135mm

STEEL Max: 8mm

26mm

2600 SPM LED

PLACA BASE + ESTATOR

14664 95,50€

INTERRUPTOR

14665 9,00€

PLACA BASE

14666 78,00€

ENGRANAJE

14667 9,00€

PALANCA RECIPROCANTE

14668 8,00€

RODILLOS DE GUÍA

14670 5,00€

ROTOR

14768 28,00€

TUBO DEL POLVO

14960 7,50€

GUÍA DE CORTE PARALELA

14961 7,50€

- Contiene:  
Hoja para madera.  
Guía de corte.  
Adaptador para el conducto del polvo.

- Características:  
Caja de engranajes metálica.  
Empuñadura ergonómica blanda.  
Interruptor de velocidad variable.  
4 niveles de acción pendular.  
Base de aluminio.  
Luz led incorporada.  
Interruptor de seguridad.

Utilízalas con las baterías JBM: una única batería apta para todas las herramientas

BATERÍAS LI-ION

2.0Ah



60012

4.0Ah



60013

6.0Ah



60015

CARGADORES



4A  
60016



CARGA RÁPIDA  
6A  
60017

# MINI SIERRA A BATERÍA CIRCULAR BRUSHLESS

**60011**

**175,00€**

2,55 4 128



Batería no incluida.

Esta herramienta ha sido diseñada para realizar tareas de **corte en madera**. La **hoja de sierra de 115 mm de diámetro y 24 dientes** hace que sea ideal para realizar **cortes longitudinales y transversales rectos** en paneles y tablones de madera, así como cortes en **ángulo de hasta 45°**.

Cuenta también con un **botón de bloqueo del gatillo** para prevenir un arranque accidental de la herramienta, y una **protección de aluminio**.



- Contiene:  
Hoja de 115mm 24T TCT.  
Guía de corte.  
Tubo para el polvo.  
Llave hexagonal.

- Características:  
Interruptor de seguridad.  
Empuñadura ergonómica.  
Protección de aluminio.  
Sistema colector de polvo.

**BRUSHLESS MOTOR**

**20V**

**4000 RPM**

**AL**

90° : 42,8mm

45° : 28mm

Ø 115mm 10mm

ROTOR **14671** 44,00€ PLACA BASE + ESTATOR **14674** 72,50€ GUÍA DE CORTE PARALELA **14963** 7,50€

INTERRUPTOR **14672** 5,00€ TUBO DEL POLVO **14962** 6,50€



## CONSUMIBLES REF. 60011

(ver pág.111)

Hoja de sierra circular 24T 115mm

**14989** **14986**



## CONSUMIBLES REF. 60007

(ver pág.111)

Hoja de sierra circular 24T 165mm

**14988** **14985**

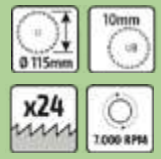

# SIERRA CIRCULAR BRUSHLESS

**60007**

**170,00€**

3,2 4 56



Batería no incluida.

Esta herramienta ha sido diseñada para realizar tareas de **corte en madera**. La hoja de sierra de **165 mm de diámetro y 24 dientes** hace que sea ideal para realizar **cortes longitudinales y transversales rectos** en paneles y tablones de madera, así como **cortes en ángulo de hasta 45°**.



**BRUSHLESS MOTOR**

**20V**

**4300 RPM**

**AL**

90° : 55mm

45° : 136mm

20mm

**LED**

- Características:  
Interruptor de seguridad.  
Empuñadura ergonómica.  
Protección de aluminio.  
Luz LED incorporada.

INTERRUPTOR **14647** 3,00€ ENGRANAJE **14650** 5,00€ GUÍA DE CORTE PARALELA **14955** 7,50€

ROTOR **14649** 50,00€ PLACA BASE + ESTATOR **14651** 86,00€

- Incluye:  
Hoja TCT de 24dientes de 165mm.  
Guía de corte.  
Llave hexagonal.







## SIERRA A BATERÍA BRUSHLESS

**60022**

11,40 1 9

**662,50€**



Batería no incluida.

Esta herramienta ha sido diseñada para realizar tareas de **corte en madera y materiales similares**. Puede ser usada para realizar **cortes en bisel**, donde se requiere un corte inclinado sobre la pieza de trabajo, **cortes en inglete**, para cortar generalmente juntas que forman un ángulo de 90°, y **cortes compuestos**, donde sea necesario un corte en ángulo simultáneo en el borde y superficie frontal de la pieza.

Viene equipada con una **bolsa de extracción para el polvo**, una **guía láser**, una **llave de ajuste** para la inserción y extracción de la hoja de corte, y una **prensa de sujeción de la pieza de trabajo**. Además, cuenta con un **botón de seguridad** para activar el gatillo para prevenir un arranque accidental de la herramienta.



MOTOR

**14691 166,50€**

INTERRUPTOR

**14692 5,50€**

BOLSA DE EXTRACCIÓN DEL POLVO

**14966 7,50€**

- Contiene:  
1 hoja de corte de 40 dientes.  
1 abrazadera de sujeción.  
1 llave para la hoja de corte.  
1 bolsa de extracción del polvo.



### CONSUMIBLES REF. 60022

(ver pág.111)

Hoja de sierra circular 40T 185mm

**14990**

**14987**



METAL



MADERA



- Material: puntas YG8, cuerpo de carburo de tungsteno



Utilízalas con las baterías JBM: una única batería apta para todas las herramientas

BATERÍAS LI-ION

2.0Ah



**60012**

4.0Ah



**60013**

6.0Ah



**60015**

CARGADORES



**60016**



**CARGA RÁPIDA 6A 60017**

VARIOS



- Contiene:  
1 boquilla para juntas.  
1 tubo de extensión.  
1 boquilla con cepillo.  
1 boquilla para suelos.

## ASPIRADOR PORTÁTIL

**60001** 1,70 4 48 **90,00€** Batería no incluida.

Este aspirador eléctrico **sin cable** ha sido diseñado para **eliminar y aspirar** cualquier resto de polvo u otro material que no sea dañino para la salud.

La **batería recargable** hace que sea **fácil de transportar** de un sitio a otro y los diferentes accesorios permiten realizar labores de limpieza en multitud de sitios y rincones distintos.



**20V** 3.8 kPa 500mL

FILTRO	TUBO DE EXTENSIÓN	BOQUILLA PARA SUELOS
<b>14628</b> 2,50€	<b>14950</b> 6,50€	<b>14952</b> 19,00€
INTERRUPTOR	BOQUILLA PARA JUNTAS	BOQUILLA CON CEPILLO
<b>14629</b> 4,00€	<b>14951</b> 9,50€	<b>14953</b> 8,50€
MOTOR		
<b>14630</b> 22,00€		

## INFLADOR / COMPRESOR A BATERÍA

Batería no incluida. **60003** 1,52 4 104 **109,50€**

Este inflador le permite inflar ruedas de automóvil y motocicletas, pelotas, lanchas neumáticas, colchones inflables, etc.

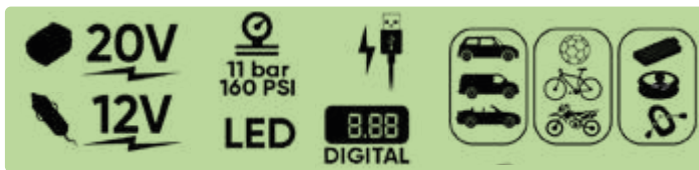

- Contiene:

BOMBA	SELECTOR DEL MODO DE TRABAJO
<b>14634</b> 36,50€	<b>14631</b> 3,50€
SOPLADOR	INTERRUPTOR DE LA LUZ LED
<b>14635</b> 10,00€	<b>14632</b> 3,50€



MANGUERA ALTA PRESIÓN **15151** 10,50€



Longitud manguera alta presión: **760 mm**  
Longitud manguera alta capacidad: **460 mm**

Utilízalas con las baterías JBM: una única batería apta para todas las herramientas





## MULTIHERRAMIENTA OSCILANTE A BATERÍA

60041

1,12

77,00€



Batería no incluida.



PALANCA DE BLOQUEO

15320 1,00€

CUBIERTA INTERMEDIA

15322 3,50€

RODAMIENTO DE BOLA 625

15321 3,00€

MOTOR

15323 24,00€

REGULADOR DE VELOCIDAD

15324 18,00€

JUNTA

15326 1,00€

PLACA BASE

15325 3,50€

MANGO AUXILIAR

15327 5,50€

La multiherramienta eléctrica oscilante le permite acoplar diferentes tipos de accesorios para poder realizar variados trabajos. Es especialmente útil para hacer rascados, lijados y vaciados en espacios estrechos.



### CONSUMIBLES

(ver pág.110)

#### SET DE CLAVOS BRAD DE CALIBRE 18

53999

54000

54002

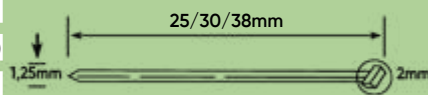

#### SET DE GRAPAS DE CALIBRE 18

54008

54010

54011

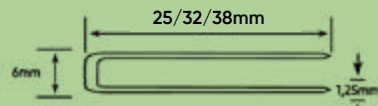

## CLAVADORA/GRAPADORA A BATERÍA

60037

2,9

221,50€



Batería no incluida.



Esta herramienta está diseñada para el **clavado y grapado** de cartón, material aislante, tela, láminas, cuero y materiales similares **en superficies de madera o materiales similares** a la madera mediante su disparo de impacto de alta potencia accionado por aire comprimido.

disparo de las cabezas de los clavos/grapas. También cuenta con un gancho de transporte para el cinturón y una empuñadura ergonómica blanda.

Viene equipada con una luz LED para indicar el estado de la herramienta; una luz LED para una mayor visibilidad durante la operación; un selector para seleccionar entre el modo de disparo simple o por contacto, para un disparo más preciso o rápido; y una rueda de ajuste para seleccionar la profundidad de

Además, viene equipada con un **pasador de contacto de seguridad**, que debe ser presionado contra la pieza de trabajo antes de accionar el gatillo para disparar clavos/grapas en el modo de disparo simple, funcionando como un mecanismo de seguridad para prevenir un arranque accidental de la herramienta.



Longitud máxima de los clavos	50 mm
	Clavos BRAD de calibre 18
Anchura máxima de la sección transversal del clavo	1.25 mm
Grosor máximo de la sección transversal del clavo	1.05 mm

Longitud máxima de las grapas	40 mm
	Grapas de corona estrecha de calibre 18 de uso ligero
Anchura máxima de la sección transversal de la grapa	1.2 mm
Grosor máximo de la sección transversal de la grapa	1 mm
Corona máxima de las grapas	6 mm

CONJUNTO PIN DE CONTACTO  
15276 45,50€

MOTOR  
15279 68,50€

CUBIERTA DE SELLADO  
15277 9,00€

CONMUTADOR  
15280 91,00€

MARCO DE SEGURIDAD  
15278 3,50€

Utilízalas con las baterías JBM: una única batería apta para todas las herramientas

#### BATERÍAS LI-ION

2.0Ah



60012

4.0Ah



60013

6.0Ah



60015

#### CARGADORES



4A  
60016



CARGA RÁPIDA 6A  
60017

## PISTOLA ENGRASADORA A BATERÍA

60038

255,00€

3,35

Kg

Batería no incluida.

Esta herramienta ha sido diseñada para **tareas de lubricación** y puede ser fácilmente transportada y manipulada en cualquier lugar gracias a su diseño sin cables.

Está equipada con una luz de trabajo LED para una mayor visibilidad en el área de trabajo, una válvula de purga de seguridad para evitar la presión excesiva y el atasco, una empuñadura blanda ergonómica para un mejor control y un botón de bloqueo del gatillo para evitar un arranque accidental de la herramienta. Además el caudal de salida de la grasa se puede cambiar hasta **8 marchas distintas** mediante la rueda de ajuste de la velocidad.



20V

9000PSI  
620BAR

Volumen/caudal  
Volume/flow rate  
200g/min

Capacidad del cartucho de grasa  
Grease cartridge capacity  
600g

Tipo de grasa hasta  
Grease type up to  
NLGI #2

760mm

8  
Niveles de caudal  
Flow level

BOMBA

15380 168,50€

PLACA BASE

15382 42,00€

MICROGATILLO

15381 5,50€

CON JUNTO DE PORTABROCAS  
Y ENGRANAJES

15386 130,00€

MANGUERA FLEXIBLE

15440 33,00€

## PISTOLA DE SILICONA A BATERÍA

Batería no incluida.

1,56

4

60032

122,50€

Esta herramienta está diseñada para **sellar cualquier hueco o grieta en una amplia variedad de materiales** como metal, vidrio, madera y cerámica.

Viene equipada con una **luz LED** para una mejor visibilidad al trabajar en sitios oscuros, un **selector de velocidad variable** y un **sistema de bloqueo** del gatillo. Además, presenta un **sistema antigoteo**. Después de soltar el gatillo 0,2-0,3s, el tiempo de encolado posterior es de 0,8s.



20V

2500 Nm

300ml

0,5-8mm/s

LED

VELOCIDAD AJUSTABLE

MECANISMO ANTIGOTEO  
ANTI-DROP MECHANISM



MOTOR

15126 19,50€

PLACA BASE

15127 29,00€



Utilízalas con las baterías JBM: una única batería apta para todas las herramientas

BATERÍAS LI-ION

2.0Ah



60012

4.0Ah



60013

6.0Ah



60015

CARGADORES



4A  
60016



CARGA RÁPIDA  
6A  
60017



## PISTOLA DE CALOR A BATERÍA

60042

1,6

Batería no incluida.

105,50€

Kg



La pistola de calor eléctrica se utiliza principalmente para la **retracción de PVC, soldadura, curvado de piezas de plástico y secado ordinario, fusión y descongelación.**



20V

15A

550°C  
1022°F

Max.  
200L/min.

0.6kg

270W



VARIOS

## PULVERIZADOR DE PINTURA A BATERÍA

60043

1,3

Esta herramienta está diseñada para pulverizar pintura en superficies de interior y de exterior.

122,50€

Kg

3

Batería no incluida.

1,3 kg

900ML

20V 243W

5m



2,5mm

60 DIN/s

700ml/min



El pulverizador dispone de tres modos diferentes de pulverización: circular, horizontal y vertical.

Utilízalas con las baterías JBM: una única batería apta para todas las herramientas

BATERÍAS LI-ION

2.0Ah



60012

4.0Ah



60013

6.0Ah



60015

CARGADORES



4A  
60016



CARGA RÁPIDA  
6A  
60017

## HIDROLIMPIADORA A PRESIÓN A BATERÍA BRUSHLESS

La hidrolimpiadora a presión eléctrica brushless está diseñada para limpiar vehículos, equipos, herramientas, muebles de exterior, etc.

60039

264,50€

4,3



Batería no incluida.



319-507 PSI  
22-25 BAR

20V

2.0-2.4 L/min

2.0 kg



Incluye una boquilla regulable para adaptar la salida del chorro de agua al tipo de suciedad y superficie sobre la cual se aplica.



TAPON ROSCADO PARA TUBO DE LA VÁLVULA INTERIOR

15481 4,50€

CONECTOR PARA TUBO DE LA VÁLVULA INTERIOR

15484 5,50€

SET DE 6 VÁLVULAS UNIDIRECCIONALES

15487 58,50€

VÁLVULA DE NO RETORNO PARA TUBO DE ENTRADA Y SALIDA

15490 4,00€

ARANDELA SUPERIOR PARA EL MUELLE DE LA VÁLVULA INTERIOR

15482 4,00€

ANILLO HERMETICO PARA INTERRUPTOR

15485 4,00€

ANILLO HERMETICO PARA TUBO INTERIOR Y EXTERIOR

15488 4,00€

MUELLE PARA VÁLVULA DE ESCAPE

15491 4,00€

MUELLE PARA VÁLVULA INTERIOR

15483 4,00€

INTERRUPTOR PARA PISTOLA LIMPIADORA

15486 9,00€

TUBO DE ENTRADA Y SALIDA

15489 10,50€

TUBO ACODADO

15492 5,00€

MUELLE

15493 4,50€



## PULVERIZADOR INDUSTRIAL A BATERÍA DE MOCHILA 15L

60027

121,50€

5,65

6

15



Batería no incluida.

Lanza telescópica extensible.

Adecuado para la **desinfección medioambiental** de hogares, lugares públicos, explotaciones ganaderas, jardines, etc., contribuyendo a la **erradicación de todo tipo de partículas infecciosas y su divulgación**, así como la **prevención de plagas y enfermedades**.

Bomba de diafragma con un **interruptor de presión inteligente** que puede ser bloqueado **para un uso continuo**.

Equipada con **4 cabezales diferentes intercambiables** para adaptar la potencia y flujo de pulverización según la necesidad requerida: 1 cabezal de cono hueco, 1 cabezal de doble cono hueco, 1 cabezal de 4 salidas, 1 cabezal de aire inducido.

Tapa con un diseño de sellado a prueba de fugas

Mango para transportar fácilmente

Soporte para colocar la lanza



Almohadilla para la espalda **TRANSPIRABLE Y ERGONÓMICA** que evita la sensación de pesadez cuando se utiliza durante un periodo largo de tiempo y facilita la transpiración y evaporación del sudor.



20V

15L

0.3-0.45 Mpa

1-1.2m

40 - 80cm



- Contiene:



Utilízalas con las baterías JBM: una única batería apta para todas las herramientas

BATERÍAS LI-ION

2.0Ah



60012

4.0Ah



60013

6.0Ah



60015

CARGADORES



4A  
60016



CARGA RÁPIDA  
6A  
60017





## MOTOSIERRA A BATERÍA BRUSHLESS

**60029**  
239,50€

3,2 1  
Kg fl

Batería no incluida.

Esta herramienta ha sido diseñada para realizar **tareas forestales en madera** tales como la tala de árboles y cortar ramas y troncos, entre otras. Está equipada con una perilla para ajustar la barra guía y la tensión de la cadena y un protector frontal para frenar la cadena en caso de contragolpe. Además, presenta un **sistema de lubricación automático** de la cadena y un botón de **bloqueo del gatillo** para prevenir un arranque accidental de la herramienta. También incluye una barra guía, una cadena y una **cubierta para proteger** tanto la barra como la cadena para su almacenaje y transporte.



BRUSHLESS MOTOR  
20V  
720W

93 dB(A) 7.8m/s 22cm

130ml 9.5mm (3/8")

254mm (10")  
350x225x245mm  
600x228x245mm

INTERRUPTOR DE SEÑAL  
**15098** 11,50€

BOMBA DE ACEITE  
**15101** 11,00€

CADENA  
**15104** 31,50€

GATILLO  
**15099** 5,50€

ROTOR  
**15102** 40,00€

BARRA GUÍA  
**15105** 30,00€

PLACA BASE  
**15100** 70,00€

ESTÁTOR  
**15103** 20,50€

MANGO AUXILIAR EN D  
**15106** 15,00€



## CORTASETOS A BATERÍA

**60031**  
161,50€

2,2 1  
Kg fl

Batería no incluida.

Esta herramienta está diseñada para realizar **tareas de jardinería** como recortar, cortar o podar setos o arbustos **de forma rápida y cómoda**. Alimentada con una batería de iones de litio, es ideal para ser transportada de un sitio a otro gracias a su diseño sin cables y su peso ligero.

Viene equipada con una **cubierta para la cuchilla** para ayudar a mantener la herramienta en buenas condiciones, una **protección** para desviar las astillas u otros desechos lejos **de las manos y los ojos del usuario**, y un **mango auxiliar** para un mejor control y comodidad. Además, cuenta con dos interruptores y un **botón de bloqueo** para evitar un arranque accidental de la herramienta.

20V  
230W

65Mn steel

<93dB(A) 1490RPM 475mm <2.5m/s2

18mm 45° 920x215x192mm

20-25mm

GATILLO TRASERO  
**15114** 6,00€

MICRO INTERRUPTOR #8  
**15115** 8,50€

PLACA BASE  
**15116** 29,50€

MOTOR  
**15117** 29,50€

CUCHILLA DE CORTE  
**15118** 52,00€

MICRO INTERRUPTOR #31  
**15119** 10,00€

GATILLO FRONTAL  
**15120** 6,50€

MANGO AUXILIAR EN D  
**15121** 12,00€



Utilízalas con las baterías JBM: una única batería apta para todas las herramientas

BATERÍAS LI-ION

2.0Ah



**60012**

4.0Ah



**60013**

6.0Ah



**60015**

CARGADORES



4A  
**60016**



CARGA RÁPIDA  
6A  
**60017**

## DESBROZADORA MULTIFUNCIÓN A BATERÍA 4 EN 1

60040

439,50€

8,3

Kg

Batería no incluida.

La máquina eléctrica multifunción 4 en 1 está diseñada para una multitud de tareas al aire libre, como desbrozar los espacios verdes, arreglar los setos del jardín, cortar ramas, etc. Es un producto ideal para el mantenimiento integral del jardín.



- Incluye una sierra de pértiga, un corta setos y una desbrozadora con un cabezal de hilo y un disco de corte de tres puntas.

- Contiene

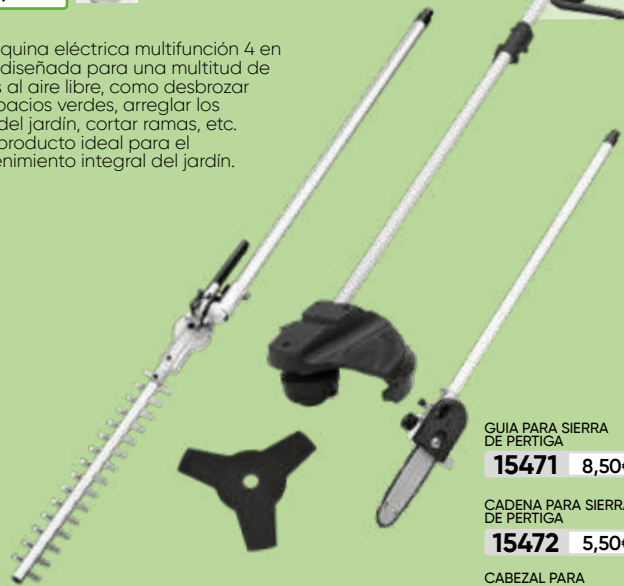

GUIA PARA SIERRA DE PERTIGA  
**15471** 8,50€

CADENA PARA SIERRA DE PERTIGA  
**15472** 5,50€

CABEZAL PARA DESBROZADORA  
**15473** 3,00€

HILO PARA DESBROZADORA  
**15474** 0,50€

DISCO DE CORTE DE TRES PUNTAS PARA DESBROZADORA  
**15475** 1,50€

COBERTURA PARA DESBROZADORA  
**15476** 1,50€

BASE DE COBERTURA PARA DESBROZADORA  
**15477** 1,00€

CUCHILLA PARA DESBROZADORA  
**15478** 0,50€



## SOPLADOR A BATERÍA

60030

118,00€

1,75

Kg

1

Bt

Batería no incluida.

Esta herramienta ha sido diseñada para **barrer hojas, pasto, papel y otros materiales similares**. Alimentada con una batería de iones de litio, es ideal para transportarla de un lugar a otro gracias a su diseño sin cables y su peso ligero. Viene equipada con un interruptor para una configuración de **alta o baja velocidad de flujo de aire y volumen**, y una **empuñadura ergonómica blanda** para un mayor control y agarre.



20V 280W  
MOTOR POWER



MICRO INTERRUPTOR  
**15107** 7,50€

GATILLO  
**15108** 5,50€

PLACA BASE  
**15109** 28,00€

CONMUTADOR  
**15110** 10,00€

MOTOR  
**15111** 32,50€

CONO DE ENTRADA  
**15112** 7,00€

TUBO DE SOPLADO  
**15113** 15,00€



Utilízalas con las baterías JBM: una única batería apta para todas las herramientas

BATERÍAS LI-ION

2.0Ah



60012

4.0Ah



60013

6.0Ah



60015

CARGADORES



4A  
60016



CARGA RÁPIDA  
6A  
60017



## FARO DE TRABAJO LED A BATERIA

**60004**  
79,00€

1,45 4 96  
Kg fl

Batería no incluida.

Este faro de trabajo LED ha sido diseñado para garantizar una **perfecta iluminación** del área de trabajo y cualquier otro lugar. Su funcionamiento con la batería de litio portátil hace que sea **ideal para moverlo libremente de un sitio a otro, y en situaciones donde no se tiene acceso al suministro eléctrico**. Aun así, si la batería se agota, es posible conectar el **cable de alimentación** provisto en la ranura de la parte trasera del faro y enchufarlo a la toma de corriente de 230V.

- Contiene:  
Cable de alimentación.



1,5m



**20V 2400 LED LM**

INTERRUPTOR  
**14636 30,00€**

TRÍPODE PARA FARO DE TRABAJO LED (REF. 60004)

**15049**  
44,50€

↑1200mm  
↓595mm

1,84  
Kg

280mm

325mm

275mm

1200mm

ILUMINACIÓN



ÁNGULO DE AJUSTE DE 360°



## PORTÁTIL DE TRABAJO LED A BATERIA

**60035**  
30,00€

0,25 5  
Kg fl

Batería no incluida.

Este faro de trabajo LED ha sido diseñado para garantizar una **perfecta iluminación del área de trabajo** y cualquier otro lugar. Su funcionamiento con la batería de litio portátil hace que sea **ideal para moverlo libremente de un sitio a otro, y en situaciones donde no se tiene acceso al suministro eléctrico**.

La lente de luces LED proporciona una potencia de luz que puede ajustarse a **500 y 1000 lúmenes**, y el cabezal del faro tiene un **ángulo de ajuste de 90°** para adaptar la dirección de la luz según convenga. También incluye una empuñadura blanda ergonómica para un mayor control y confort y un gancho para poder colgarlo a cualquier objeto.



**20V 10W**

500 Lm

1000 Lm

90°

220-240V 50Hz

Parpadeante Flashing



FUENTE DE LUZ  
**15124 9,50€**

PLACA BASE  
**15125 23,00€**



Utilízalas con las baterías JBM: una única batería apta para todas las herramientas

BATERÍAS LI-ION

2.0Ah



**60012**

4.0Ah



**60013**

6.0Ah



**60015**

CARGADORES



4A  
**60016**  
48,50€



CARGA RÁPIDA 6A  
**60017**  
63,50€

## PATINETE ELÉCTRICO 36V 350W BRUSHLESS

53920

537,00€

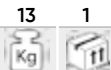

Batería incluida e incorporada.

- Dimensiones desplegado: 109x42x109cm
- Tamaño de la base: 67x14cm
- Altura del manillar: 109cm
- Limite de peso: hasta 107kg
- Edad recomendada: 15+
- Tamaño del neumático: 22 cm
- Max. Velocidad: 25km/h
- Autonomía: hasta 26 km

**350W**

**BRUSHLESS MOTOR**

**25 km/h**

**26km**

**107kg**

**36V 1500mAh**

**100-240V**

**3.4Ah**

**LCD** Pantalla Screen

**Disco trasero** Rear disc

**22cm**

**S** Acero Steel

15+



Gestiona todas las **características técnicas** desde tu móvil:

- Indicador de nivel de batería.
- Cambia el modo limite de velocidad.
- Cambia el modo de arranque.
- Controla la velocidad a la que circulas.
- Enciende/apaga la luz LED.
- Bloquea el patinete para que no pueda ser usado o robado (bloqueo de motor).

**FRENO DE DISCO TRASERO**



**PANTALLA LCD**



**DIMENSIONES PLEGADO**  
109X42X46CM



## ROBOT ASPIRADOR

54020

288,00€



Este robot inteligente realiza de forma automática tareas de **aspiración y fregado**. Gracias a su sistema de mapeo inteligente puede realizar una limpieza exhaustiva de la zona de trabajo. Es altamente configurable ya que le permite elegir entre diferentes modos de funcionamiento, ajustar niveles de aspiración y humedad y programar tareas para horas determinadas.

**20W**

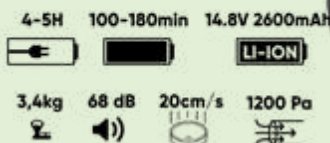

**CONEXIÓN APP**



**Máxima superficie cubierta**  
Maximum covered area  
**120m<sup>2</sup>**

**Capacidad tanque de agua**  
Water tank capacity  
**300ml**

**Capacidad del depósito de polvo**  
Dust box capacity  
**300ml**

**CEPILLO LATERAL IZQUIERDO**

**15340** 5,50€

**CEPILLO PRINCIPAL**

**15342** 9,00€

**CEPILLO DE LIMPIEZA**

**15344** 6,50€

**ESTACION BASE**

**15346** 24,00€

**CEPILLO LATERAL DERECHO**

**15341** 5,50€

**FILTRO HEPA**

**15343** 9,50€

**JUEGO DE 5 MOPAS**

**15345** 10,50€

**TRANSFORMADOR DE CORRIENTE**

**15349** 8,50€

## ROBOT CORTACÉSPED

52598

1.080,00€

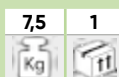

- Robot autónomo cortacésped.
- Fácil de almacenar e inalámbrico.

Altura de corte: 2,5 - 5,5cm  
Ancho de corte: 18cm  
Estación de carga  
Velocidad de giro de la cuchilla: 3500rpm

**5200 mAh**

Capacidad de la batería  
Battery capacity

**1400m<sup>2</sup>**

Superficie de corte  
Mowing area

**2,5H**

**2H**

**22m/min**

**115,44W**

Consumo de energía  
Power consumption

**AC 100-240V**  
50/60Hz  
Tensión de entrada  
Input Voltage

**DC 15-25,5V**  
Tensión de salida  
Output Voltage

**IP X4**

**70 dB**



**CABLE DELIMITADOR 150M**

**15424** 105,00€

**CLAVOS PARA ESTACION DE ACOPLAMIENTO**

**15427** 9,00€

**ADAPTADOR**

**15430** 83,00€

**GARAJE PARA CORTACÉSPED**

**15433** 169,00€

**MOTOR DE CORTE**

**15436** 97,00€

**GRAPAS PARA CABLE DELIMITADOR**

**15425** 50,00€

**BATERÍA 22.2V, 2600MAH**

**15428** 238,00€

**ESTACION BASE**

**15431** 241,00€

**RUEDA TRASERA Y MOTOR**

**15434** 147,00€

**PLACA BASE**

**15437** 305,50€

**HOJA DE CORTE Y TORNILLOS**

**15426** 10,00€

**CABLE DE EXTENSION 5M**

**15429** 23,50€

**CONECTOR DE CABLE DE CONEXIÓN**

**15432** 18,50€

**PLACA DE LA CORTE Y PLACA DE PROTECCIÓN**

**15435** 24,50€

**SENSOR DE CABLE DELIMITADOR**

**15438** 31,00€

**RUEDAS DELANTERAS**

**15439** 52,00€

**CONEXIÓN APP**





# Utilízaslas con las baterías JBM: una única batería apta para todas las herramientas

Tres tipos de batería y dos tipos de cargador. Escoge el que prefieras!

\*Baterías y cargadores NO INCLUIDOS en las herramientas.



## BATERÍAS LI-ION



INDICADORES DE CARGA LED



SISTEMA PROTECTOR DE CORTOCIRCUITOS



SISTEMA PROTECTOR DE SOBRECARGAS



SISTEMA PROTECTOR DE SOBRECARGAS

### 20V

### 12V

2.0Ah



4.0Ah



6.0Ah



2.0Ah



PARA REF. 60024

**60012**

0,45 5 1.080

41,50€



**60013**

0,75 5 840

79,50€



**60015**

1 5 550

122,00€



**60026**

0,20 8 5

33,00€



## CARGADORES

50-60Hz

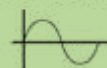

100V  
240V



INDICADORES DE CARGA LED



SISTEMA PROTECTOR DE SOBRECARGAS



SISTEMA PROTECTOR DE SOBRECARGAS

### 20V



SISTEMA PROTECTOR DE CORTOCIRCUITOS

### 12V



4A

**60016**

0,70 5 240

48,50€



6A  
CARGA RÁPIDA



**60017**

0,80 5 240

63,50€



CARGADOR 12V  
PARA REF. 60026

**60025**

0,30 5 4

28,50€



2.0AH 4.0AH  
30min +/-10min 60min +/-15min

6.0AH  
90min +/-15min

2.0AH 4.0AH  
30min +/-10min 45min +/-10min

6.0AH  
60min +/-15min

2.0AH  
60min +/-10min



## CINCELES SDS-PLUS

- Material: acero 40Cr, superficie arenada.  
- Para albañilería: piedra, ladrillo, pared, hormigón, cemento, etc.



60023

EN PUNTA - 14x250mm

14837

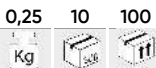

3,00€

PLANO - 40x250mm

14838

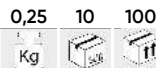

3,00€

ACANALADO - 250mm

14840

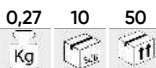

4,00€

PLANO - 20x250mm

14839

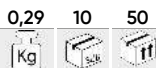

4,00€



ACCESORIOS

## ESTUCHE DE BROCAS SDS-PLUS PARA TALADRO PERCUTOR

53850



13,50€



60023



PARA ALBAÑILERÍA



5x110, 6x110, 6x160, 8x110, 8x160, 10x160, 12x160mm

- Flauta simple, punta plana, superficie arenada.  
- Material: puntas de aleación de acero YG8, cuerpo de acero al carbono.  
- Para albañilería: piedra, ladrillo, pared, hormigón, cemento, etc.



### DESPIECE DISPONIBLE

REF.	mm	Kg	Paq	Pcs	€
14826	Ø 5x110mm	0,05	125	500	1,50€
14828	Ø 6x110mm	0,05	25	500	1,50€
14830	Ø 8x110mm	0,04	25	500	1,50€
14829	Ø 6x160mm	0,04	25	500	1,50€
14831	Ø 8x160mm	0,05	25	500	1,50€
14832	Ø 10x160mm	0,05	25	200	2,00€
14920	Ø 12x160mm	0,10	100	200	2,50€

### TAMBIÉN TE PUEDE INTERESAR...

REF.	mm	Kg	Paq	Pcs	€
14825	Ø 4x110mm	0,05	100	200	1,50€
14827	Ø 5x160mm	0,04	25	500	2,00€
14833	Ø 10x210mm	0,10	20	200	2,05€
14834	Ø 12x210mm	0,10	100	200	2,50€
14835	Ø 14x210mm	0,10	20	125	3,00€
14836	Ø 16x210mm	0,14	20	120	3,50€

## ADAPTADOR SDS PLUS 1/2" PARA PORTABROCAS

14841

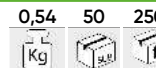

1,50€

60023

- Material: acero 40Cr, superficie arenada  
- Longitud: 75mm  
- Diámetro: 10mm

PARA ALBAÑILERÍA

ACERO 40CR



## PORTABROCAS DE ROSCA 2-13MM DE 1/2"-20UNF

14842



7,50€

60023

- Tipo: sin llave.  
- Capacidad: 2-13mm.  
- Montaje: 1/2"-20UNF.  
- Material: Acero.  
- Longitud: 6cm.  
- Diámetro: 4cm.



## ESTUCHES DE BROCAS PARA ALBAÑILERÍA

- Material: puntas de aleación de acero YG8, cuerpo de acero al carbono.  
- Para albañilería: piedra, ladrillo, pared, hormigón, cemento, etc.



60006

3-10MM

53861



5,00€

8 PCS

3x60, 4x75, 5x80, 6x100, 7x100, 8x120, 9x120, 10x120mm

4-10MM

53860



3,50€

5 PCS

4x75, 5x80, 6x100, 8x120, 10x120mm

### DESPIECE DISPONIBLE

REF.	mm	Kg	Paq	Pcs	€
14907	Ø 3x60mm	0,01	50	100	0,50€
14908	Ø 4x75mm	0,01	50	100	0,60€
14909	Ø 5x80mm	0,01	50	100	0,80€
14910	Ø 6x100mm	0,01	50	100	1,00€
14911	Ø 7x100mm	0,01	50	100	1,30€
14912	Ø 8x120mm	0,05	50	100	1,55€
14913	Ø 9x120mm	0,05	50	100	1,90€
14914	Ø 10x120mm	0,04	20	100	2,10€

### TAMBIÉN TE PUEDE INTERESAR...

REF.	mm	Kg	Paq	Pcs	€
14915	Ø 11x150mm	0,05	20	100	2,65€
14916	Ø 12x150mm	0,06	20	100	2,95€
14917	Ø 13x150mm	0,10	20	100	3,45€





## ESTUCHE DE BROCAS HELICOIDALES HSS-G 4341

- Material: HSS-G 4341.  
- Para metales: acero inoxidable, hierro, cobre, aluminio, etc.

1-10MM

**53852**  
175,50€

4,20 4 **170**  
Kg **PCS**

1x34, 1.5x40, 2x49, 2.5x57, 3x61, 3.5x70, 4x75, 4.5x80, 5x86, 5.5x93, 6x93, 6.5x101, 7x109, 7.5x109, 8x117, 8.5x117, 9x125, 9.5x125, 10x133mm

- Incluye 170 brocas:  
1.0 - 8.0mm x 10 brocas (incrementos de 0.5mm).  
8.5 - 10mm x 5 brocas (incrementos de 0.5mm).



HSS-G  
4341  
  
METAL  
PARA  
METALES

60006



1-13MM

**53856**  
53,00€

1,32 5 10 **25**  
Kg **PCS**

1x34, 1.5x40, 2x49, 2.5x57, 3x61, 3.5x70, 4x75, 4.5x80, 5x86, 5.5x93, 6x93, 6.5x101, 7x109, 7.5x109, 8x117, 8.5x117, 9x125, 9.5x125, 10x133, 10.5x133, 11x142, 11.5x142, 12x151, 12.5x151, 13x151mm



1-10MM

**53854**  
23,50€

0,63 5 20 **19**  
Kg **PCS**

1x34, 1.5x40, 2x49, 2.5x57, 3x61, 3.5x70, 4x75, 4.5x80, 5x86, 5.5x93, 6x93, 6.5x101, 7x109, 7.5x109, 8x117, 8.5x117, 9x125, 9.5x125, 10x133mm



DESPIECE DISPONIBLE

REF.	mm				€
14868	Ø 1x34mm	0,01	50	400	0,55€
14869	Ø 1.5x40mm	0,01	50	400	0,60€
14870	Ø 2x49mm	0,01	50	400	1,00€
14871	Ø 2.5x57mm	0,01	50	400	1,00€
14872	Ø 3x61mm	0,01	50	400	1,00€
14873	Ø 3.5x70mm	0,01	50	400	1,00€
14874	Ø 4x75mm	0,01	50	400	1,00€
14875	Ø 4.5x80mm	0,01	50	400	1,50€
14876	Ø 5x86mm	0,01	50	300	1,50€
14877	Ø 5.5x93mm	0,02	50	300	1,50€
14878	Ø 6x93mm	0,02	25	400	2,00€
14879	Ø 6.5x101mm	0,02	25	400	2,00€
14880	Ø 7x109mm	0,03	25	400	2,50€
14881	Ø 7.5x109mm	0,03	25	400	2,50€
14882	Ø 8x117mm	0,04	25	400	3,00€
14883	Ø 8.5x117mm	0,04	25	400	3,50€
14884	Ø 9x125mm	0,05	25	400	3,65€
14885	Ø 9.5x125mm	0,05	25	400	4,00€
14886	Ø 10x133mm	0,06	25	400	4,60€
14887	Ø 10.5x133mm	0,07	25	400	5,00€
14888	Ø 11x142mm	0,08	25	400	6,00€
14889	Ø 11.5x142mm	0,09	25	400	6,50€
14890	Ø 12x151mm	0,10	25	300	7,00€
14891	Ø 12.5x151mm	0,09	25	200	7,50€
14892	Ø 13x151mm	0,09	25	200	8,00€

ACCESORIOS

## ESTUCHE DE BROCAS HELICOIDALES HSS-R 4241 (NEGRO)

- Material: HSS-R 4241 NEGRO.  
- Para metales: acero inoxidable, hierro, cobre, aluminio, etc.

1-10MM

**53851**  
74,50€

3,80 4 **170**  
Kg **PCS**

1x34, 1.5x40, 2x49, 2.5x57, 3x61, 3.5x70, 4x75, 4.5x80, 5x86, 5.5x93, 6x93, 6.5x101, 7x109, 7.5x109, 8x117, 8.5x117, 9x125, 9.5x125, 10x133mm

- Incluye 170 brocas:  
1.0 - 8.0mm x 10 brocas (incrementos de 0.5mm).  
8.5 - 10mm x 5 brocas (incrementos de 0.5mm).



HSS-R  
4241  
  
METAL  
PARA  
METALES

60006



DESPIECE DISPONIBLE

1-13MM

**53855**  
21,50€

1,19 5 10 **25**  
Kg **PCS**

1x34, 1.5x40, 2x49, 2.5x57, 3x61, 3.5x70, 4x75, 4.5x80, 5x86, 5.5x93, 6x93, 6.5x101, 7x109, 7.5x109, 8x117, 8.5x117, 9x125, 9.5x125, 10x133, 10.5x133, 11x142, 11.5x142, 12x151, 12.5x151, 13x151mm



1-10MM

**53853**  
11,50€

0,58 5 20 **19**  
Kg **PCS**

1x34, 1.5x40, 2x49, 2.5x57, 3x61, 3.5x70, 4x75, 4.5x80, 5x86, 5.5x93, 6x93, 6.5x101, 7x109, 7.5x109, 8x117, 8.5x117, 9x125, 9.5x125, 10x133mm



REF.	mm				€
14843	Ø 1x34mm	0,01	50	400	0,50€
14844	Ø 1.5x40mm	0,01	50	400	0,50€
14845	Ø 2x49mm	0,01	50	400	0,50€
14846	Ø 2.5x57mm	0,01	50	400	0,50€
14847	Ø 3x61mm	0,01	50	400	0,50€
14848	Ø 3.5x70mm	0,01	50	400	0,50€
14849	Ø 4x75mm	0,01	50	400	1,00€
14850	Ø 4.5x80mm	0,01	50	400	1,00€
14851	Ø 5x86mm	0,01	50	300	1,00€
14852	Ø 5.5x93mm	0,02	50	300	1,00€
14853	Ø 6x93mm	0,02	25	400	1,00€
14854	Ø 6.5x101mm	0,02	25	400	1,00€
14855	Ø 7x109mm	0,03	25	400	1,00€
14856	Ø 7.5x109mm	0,03	25	400	1,00€
14857	Ø 8x117mm	0,03	25	400	1,50€
14858	Ø 8.5x117mm	0,04	25	400	1,50€
14859	Ø 9x125mm	0,04	25	400	1,50€
14860	Ø 9.5x125mm	0,05	25	400	2,00€
14861	Ø 10x133mm	0,06	25	400	2,00€
14862	Ø 10.5x133mm	0,07	25	400	2,00€
14863	Ø 11x142mm	0,07	25	400	2,50€
14864	Ø 11.5x142mm	0,07	25	400	2,50€
14865	Ø 12x151mm	0,08	25	300	2,50€
14866	Ø 12.5x151mm	0,09	25	200	3,00€
14867	Ø 13x151mm	0,09	25	200	3,00€

## ESTUCHE DE PUNTAS DE IMPACTO CON ADAPTADOR RÁPIDO S2

**53857** 0,40 6 24 1.416  
23,50€

60005/60006

ACERO S2 **49 PCS**

- Material: acero S2, óxido negro con ribete, DIN estándar.

- Incluye:

- 49 puntas de impacto de 25mm: PH1x3, PH2x3, PH3x3, PZ1x3, PZ2x3, PZ3x3, SL4x2, SL5x2, SL6x2, H:3,4,5, T:10x2, 15x2, 20x2, 25x2, 27x2, 30x2, 40x2
- T INVOLABLE: 10, 15, 20, 25, 27, 30, 40
- 7 puntas de impacto de 65mm con ribete: PH2, PH3, PZ1, PZ2, T20, T25, SL6
- 1 adaptador de mandril de liberación rápida de 60mm.



EN EXPOSITOR DE 6 UNIDADES



## ESTUCHE DE PUNTAS DE IMPACTO CON ADAPTADORES S2

**53858** 0,55 6 24 768  
25,00€

60005/60006

ACERO S2 **21 PCS**

- Material: acero S2, óxido negro con ribete.

- Incluye 21 puntas de impacto de 25mm:

- 4x PH:1,2,2,3
- 3x PZ:1,2,3
- 4x H:3,4,5,6
- 4x SL:3,4,5,6
- 6x T:10,15,20, 25, 30, 40
- 6x puntas de impacto de 75mm: T15, T20, T25, PH2, PZ2, SL5
- 1x barra de extensión de 80mm
- 1x adaptador de mandril de liberación rápida de 60mm
- 4x llaves de tuercas de 50mm: 6,7,8,10mm



EN EXPOSITOR DE 6 UNIDADES



## SET DE CLAVOS BRAD DE CALIBRE 18

REF.	DESCRIPCIÓN	kg	caj.	caj.	€
53999	25x1.25mm	0,20	50		2,00€
54000	30x1.25mm	0,24	50		2,50€
54002	38x1.25mm	0,29	50		3,00€

60037

**1000 PCS**

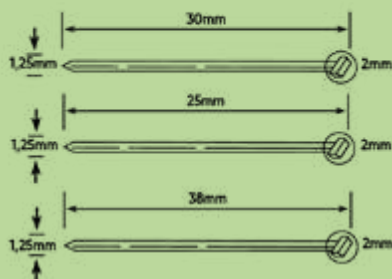

## SET DE GRAPAS DE CALIBRE 18

REF.	DESCRIPCIÓN	kg	caj.	caj.	€
54008	25x6mm	0,43	40		3,50€
54010	32x6mm	0,47	40		4,50€
54011	38x6mm	0,63	40		5,00€

60037

**1000 PCS**

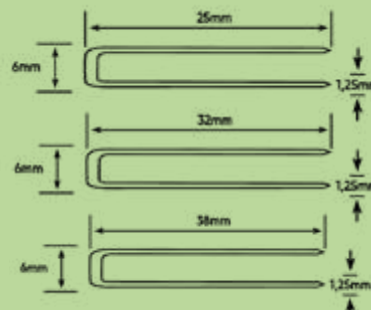

## ESTUCHE DE SIERRAS DE CORONA BIMETÁLICAS CON ADAPTADORES

**53859** 1,35 5 10 120  
57,00€

60006

HSS M42 4-6TPI **8 PCS**



PARA METALES Y ACERO INOXIDABLE

- Para cortar metal y acero inoxidable.
- Material de las sierras: Puntas: Bimetal HSS M42, 4-6TPI. Cuerpo: Acero al carbono.
- Material husillos: Bimetal HSS.



x6	22, 29, 35, 44, 51, 68mm
x2	14-30mm, 32-152mm



### DESPIECE DISPONIBLE

REF.	mm	kg	caj.	caj.	€
14901	Sierra 22mm	0,04	10	50	3,60€
14902	Sierra 29mm	0,08	10	50	4,60€
14903	Sierra 35mm	0,10	10	50	5,25€
14904	Sierra 44mm	0,12	10	50	6,85€
14905	Sierra 51mm	0,12	10	50	8,50€
14906	Sierra 68mm	0,19	10	50	10,15€
14934	Husillo 14-30mm	0,07	10	50	4,25€
14935	Husillo 32-152mm	0,2	10	50	8,40€



# HOJAS DE SIERRA

## PARA METAL (ACERO INOXIDABLE, ALUMINIO, COBRE)

PARA	REF.	DESCRIPCIÓN	€
60011	14989	Hoja de sierra circular 24T 115mm 0,08 - 20 100	6,00€
60007	14988	Hoja de sierra circular 24T 165mm 0,19 - 20 40	8,00€
60022	14990	Hoja de sierra circular 40T 185mm 0,26 - 20 40	10,50€
60019	14995	Hojas de sierra de sable 150mm 24TPI 0,01 2 20 200	8,00€
60010	14993	Hojas de sierra de calar T118A 0,01 5 20 200	5,00€

## PARA MADERA

PARA	REF.	DESCRIPCIÓN	€
60011	14986	Hoja de sierra circular 24T 115mm 0,07 - 20 100	4,00€
60007	14985	Hoja de sierra circular 24T 165mm 0,18 - 20 40	6,00€
60022	14987	Hoja de sierra circular 40T 185mm 0,24 - 20 40	8,50€
60019	14994	Hojas de sierra de sable 150mm 6TPI 0,01 2 20 200	3,50€
60010	14991	Hojas de sierra de calar T244D 0,01 5 20 200	2,00€

**14989** **14986**

METAL MADERA

Ø 115mm 10mm x24 1.000 RPM



- Material: puntas YG8, cuerpo de carburo de tungsteno.

**14988** **14985**

METAL MADERA

Ø 165mm 20mm x24 1.000 RPM



- Material: puntas YG8, cuerpo de carburo de tungsteno

**14990** **14987**

METAL MADERA

Ø 185mm 25.4mm 1.3mm x40 7.000 RPM



- Material: puntas YG8, cuerpo de carburo de tungsteno

**14995**

METAL 150mm 24 TPI 10mm CORTE MÁX. MAX. CUT



- Material: acero HSS.

**14993**

METAL 76mm 8mm CORTE MÁX. MAX. CUT T118A



- Material: acero HSS.

**14994**

MADERA 150mm 6 TPI 150mm CORTE MÁX. MAX. CUT



- Material: acero con alto contenido en carbono.

**14991**

MADERA 100mm 100mm CORTE MÁX. MAX. CUT T244D



- Material: acero con alto contenido en carbono.

## DISCOS DE CORTE

- Material: alúmina monocristalina fundida SA 50% / Alúmina fundida blanca 50%.

### PARA METAL

REF.	DESCRIPCIÓN	€
14893	T42 - 115x2.5mm 0,05 50 100	2,00€
14894	T42 - 125x2.5mm 0,70 50 100	2,60€
14895	T27 - 115x6mm 0,15 25 100	2,90€
14896	T27 - 125x6mm 0,78 25 100	3,60€



### PARA ACERO INOXIDABLE

REF.	DESCRIPCIÓN	€
14897	T41 - 115x1mm 0,01 50 400	1,00€
14898	T41 - 125x1mm 0,03 50 400	1,00€
14899	T41 - 115x1.6mm 0,03 50 400	2,60€
14900	T41 - 125x1.6mm 0,04 50 400	2,85€



PARA METALES Y ACERO INOXIDABLE



60008/60028

**14893** **T42**

Ø 115mm 22.23mm 2.5mm 13.300 RPM 80 m/s

**14895** **T27**

Ø 115mm 22.23mm 6mm 13.300 RPM 80 m/s

**14897** **T41**

Ø 115mm 22.23mm 1mm 13.300 RPM 80 m/s

**14898** **T41**

Ø 125mm 22.23mm 1mm 12.200 RPM 80 m/s

**14894** **T42**

Ø 125mm 22.23mm 2.5mm 12.200 RPM 80 m/s

**14896** **T27**

Ø 125mm 22.23mm 6mm 12.200 RPM 80 m/s

**14899** **T421**

Ø 115mm 22.23mm 1.6mm 13.300 RPM 80 m/s

**14900** **T41**

Ø 125mm 22.23mm 1.6mm 12.200 RPM 80 m/s

## TUERCA DE SUJECIÓN RÁPIDA M14 PARA AMOLADORA ANGULAR

**15014**

20,00€

0,10 50 100 Kg 50 11



60008/60028



## BANDEJA SOPORTE

**14622**  
17,00€

0,9 10  
Kg fl

PARA REF. 60001, 60003,  
60004, 60020

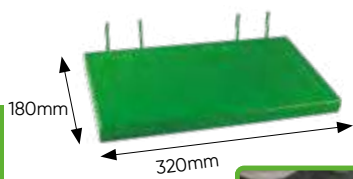

**14624**  
17,00€

0,6 10  
Kg fl

PARA REF. 60007,  
60010, 60011

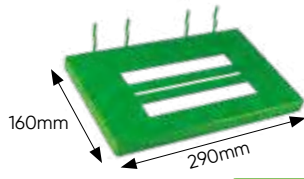

## SOPORTE

**14625**  
14,00€

0,5 10  
Kg fl

PARA REF. 60008,  
60009

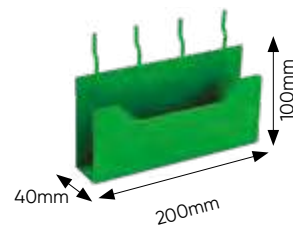

ALMACENAMIENTO

## GANCHO

**14623**  
8,00€

0,1 10  
Kg fl

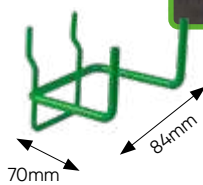

**14626**  
7,00€

0,1 10  
Kg fl

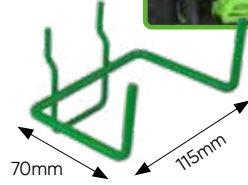

## MOCHILA PARA HERRAMIENTAS ELÉCTRICAS

**53702**  
24,50€

1 5 180  
Kg fl

PEQUEÑA



**53703**  
32,00€

1,40 5 120  
Kg fl

MEDIANA



**53704**  
36,00€

1,65 5 120  
Kg fl

GRANDE



## MOCHILA PARA HERRAMIENTAS ELÉCTRICAS - GRANDE

**53782**  
14,00€

0,70 20 60  
Kg fl

25Kg/13L



## MOCHILA PARA HERRAMIENTAS

**53258**  
75,40€

2,6 2 32  
Kg fl

1.165mm 575mm 230mm

15Kg

- No incluye herramientas.



## MALETA DE HERRAMIENTAS

**53253**  
98,00€

4,5 2 12  
Kg fl

420mm 360mm 250mm

20Kg/18L

- 600D Polyester.  
- No incluye herramientas.





PORTÁTILES DE TALLER



114

PORTÁTILES DE LUZ FRONTAL / TOMAS DE MECHERO Y TRANSFORMADORES



118

LUPAS LED / LÁMPARAS DE BOLSILLO



119

BARRAS LED



120

LÁMPARAS DE INSPECCIÓN / ALINEADOR DE FAROS



121

BALIZA DE EMERGENCIA / GIROFAROS



122

AVISADORES ACÚSTICOS



125

FAROS DE TRABAJO



125

PARA REMOLQUE

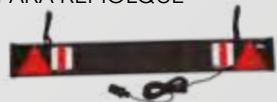

128

LÁMPARAS TURISMO



129



# ILUMINACIÓN



SERIE362

## PORTÁTIL DE TALLER COB 400LM

53734

18,00€

0,25 20 60 1.080  
Kg ft ft ft



BASE ROTATIVA  
360°  
IMANTADA

32mm

380mm

potente luz LED :  
de 30Lm a 400Lm

SELECTOR DE  
INTENSIDAD  
DE LUZ

CON COLGADOR

CARGADOR USB

EN EXPOSITOR  
DE 20 UNIDADES

## PORTÁTIL DE TALLER CON BASE IMANTADA ARTICULADA

53465

38,00€

0,4 12 24 384  
Kg ft ft ft



53466

39,90€

0,4 12 24 384  
Kg ft ft ft



53467

47,00€

0,4 12 24 336  
Kg ft ft ft

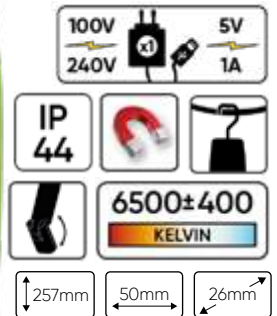

EN EXPOSITOR  
DE 12 UNIDADES

## LÁMPARA PORTÁTIL COB PLEGABLE CON BASE GIRATORIA IMANTADA ARTICULADA

53216

49,00€

0,6 10 120  
Kg ft ft



390mm

100mm

180mm

## LÁMPARA PORTÁTIL COB FLEXIBLE CON BASE IMANTADA

53217

29,00€

0,3 20 620  
Kg ft ft



380mm

45mm



## PORTÁTIL DE TALLER COB EXTRAFINO

53519

29,00€

0,2 12 72 576



EXTRAFINO

12mm

300mm

38mm



EN EXPOSITOR DE 12 UNIDADES



## LÁMPARA PORTÁTIL SLIM LED C.O.B. ARTICULADA CON BATERÍA RECARGABLE

52536

57,00€

0,4 10 330

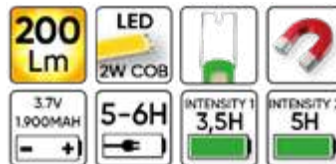

LÁMPARAS PORTÁTILES

## PORTÁTIL DE TALLER 24+6 LEDS CON BATERÍA RECARGABLE

51889

45,00€

0,43 10 360



255mm 56mm

DOBLE GANCHO Y DOBLE IMÁN



## PORTÁTIL EXTRAPLANO CON LED C.O.B.

52384

19,00€

0,33 20 600



- Longitud del cable: 5m  
- DC Longitud del cable: 0,1m  
- DC longitud del cable de la pinza: 0,3m

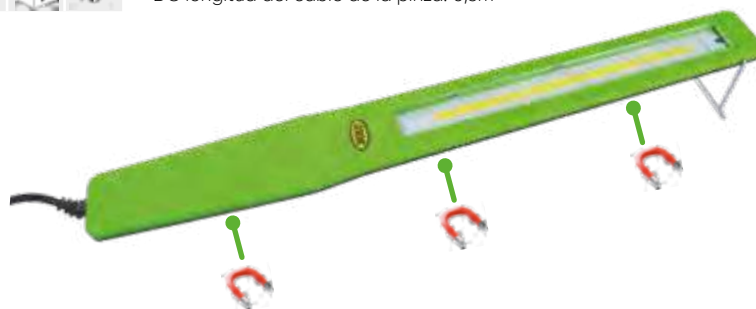

7mm

90mm

325mm



## LÁMPARA DE BOLSILLO CON BATERÍA

**53776** 0,15 12 48 1.728  
16,50€

90-250 Lm 2,5H  
3,5-6H 3.7V 15Ah  
ABS



EN EXPOSITOR DE 12 UNIDADES



### 3 MODOS DE LUZ



LÁMPARAS PORTÁTILES

## LÁMPARA DE BOLSILLO CON BATERÍA

**52987** 0,17 10 40 640  
19,00€



EN EXPOSITOR DE 10 UNIDADES

120 Lm LED 3W COB 3.7V 1000mAh  
2,5H 2,5H

## LÁMPARA LED COB CON BASE ARTICULADA

**52883** 0,31 20 640  
38,00€



180+80 Lm LED 2W COB 3.7V 1.800MAH  
4-5H 3,5-4H

## LÁMPARA PORTÁTIL COB ULTRAVIOLETA FLEXIBLE CON BASE IMANTADA

**53530** 0,3 5 20 620  
43,50€



LUZ ULTRAVIOLETA

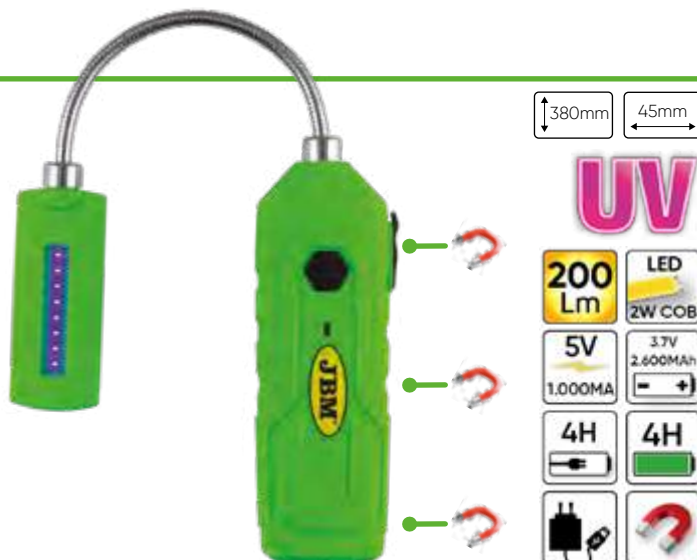

380mm 45mm

**UV**  
200 Lm LED 2W COB 5V 3.7V 2.600MAH 1.000MA  
4H 4H



## LÁMPARA LED DE TALLER 400LM

53780

14,50€

0,45 5 20 320



CABLE DE ALIMENTACIÓN DE 2,5M

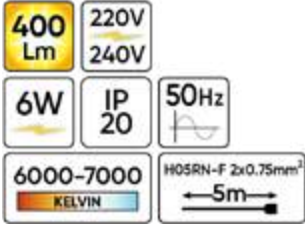

INCLUYE GANCHO SUPERIOR PARA PODER TRABAJAR CÓMODAMENTE

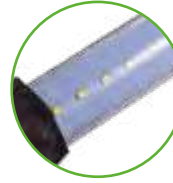

POTENTE LUZ PERFECTA PARA ILUMINAR LA ZONA DE TRABAJO

## FARO DE TRABAJO RECARGABLE

53974

35,50€

0,75 5 20 240



¿Quieres ver cómo funciona?



4 MODOS DE LUZ  
100% 50% SOS FLASH



MULTIPOSICIÓN



## FARO PORTÁTIL LED CON LINTERNA / ALTAVOZ / CARGADOR

53199

24,00€

0,4 18 306



- Gancho de fijación.  
- Altavoz bluetooth



# PORTÁTILES DE LUZ FRONTAL

COB + LED 350LM

**54004** 0,10 12 96 1.920  
23,00€

**COB**  
350Lm  
5W COB

**LED**  
90Lm  
3W XPE

3.5V  
1200Ah

2.5H

IP  
X4

2m

Gel de sílice  
Silica gel

70g

USB

Hand icon



350Lm 150Lm



150Lm 60Lm



- Material: Gel de sílice.
- Indicador de encendido, indicador de inducción.
- Modo de activación por sensor de movimiento.
- Cable de carga USB incluido.

BOTÓN SENSOR DE MOVIMIENTO



Pulsar para activar/desactivar.  
Pasar la mano por delante del botón para encender y apagar la luz.

ON +



CREE + COB 800LM

**53569** 0,35 10 50 400  
18,00€

MAX  
800  
Lm

High/Low  
Flash/COB

x2  
18650

LED  
COB + CREE

150M

+2,5H



BATERÍAS  
RECARGABLES



REGULADOR DE ENFOQUE

INDICADOR DE LUZ ENCENDIDA



**3** MODOS DE LUZ



90°



350LM

**53568** 0,2 10 100 400  
12,00€

High/Low  
Flash/SOS

2000  
mAh  
Li-Ion

MAX  
350  
Lm

150M

+2,5H



REGULADOR DE ENFOQUE

90°



**3** MODOS DE LUZ





## LUPA LED DE MESA

53227

28,00€

0,6 6 24 192



- Hasta 500 ciclos de carga.  
- LED de luz blanca, grandes ahorros.  
- Vida extendida y alta luminosidad.



## LUPA DE 8 LEDS (5x)

53085

29,00€

0,31 10 40 1.500



Incluye:  
- Paño limpialupa  
- Funda antigolpes

## LINTERNA PLÁSTICA 9 LEDS

52555

1,80€

52558

1,80€

93mm 30mm

0,03 12 48 192 3.456



27 Lm x9 LED x3 AAA Incluidas

## LINTERNA DE 21 LEDS

51326

4,40€

0,07 12 144 2.880



63 Lm x21 LED x3 AAA Incluidas



EN EXPOSITOR DE 12 UNIDADES

- Artículo Auxiliar.  
- 21 Led's de larga duración.

## MINI LINTERNA IMANTADA

53427

5,00€

0,05 12 96 3.072



45 Lm x6 LED x3 AAA Incluidas

160mm 32mm



EN EXPOSITOR DE 12 UNIDADES



## LINTERNA DINAMO DE 2 LEDS

51573

2,50€

0,07 12 96 3.456



6 Lm x2 LED

PRESENTACIÓN EN CAJA INDIVIDUAL

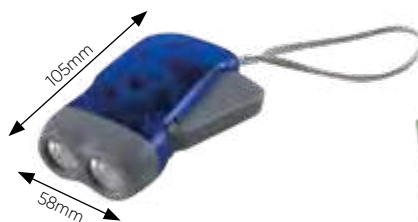

## LINTERNA DINAMO DE 3 LEDS

51446

2,50€

0,08 12 96 3.456



10 Lm x3 LED



EN EXPOSITOR DE 12 UNIDADES



## PILAS DE RECAMBIO

"AAA" R03 1,5V

51258

0,15€

0,01 60 2.400



PARA REF. 51325, 51326, 51829, 52233, 51001, 52582, 52555, 52556, 52557, 52558, 52584



x3

PILA CUADRADA 9V

10923

1,10€

0,05 10 500 1.000



PARA REF. 52162, 52450, 51929, 50942



## BARRA LED IMANTADA

53707

2,25 4 80

152,50€



1000 Lm

LED 3x5W COB

3 LEDS 1000LM

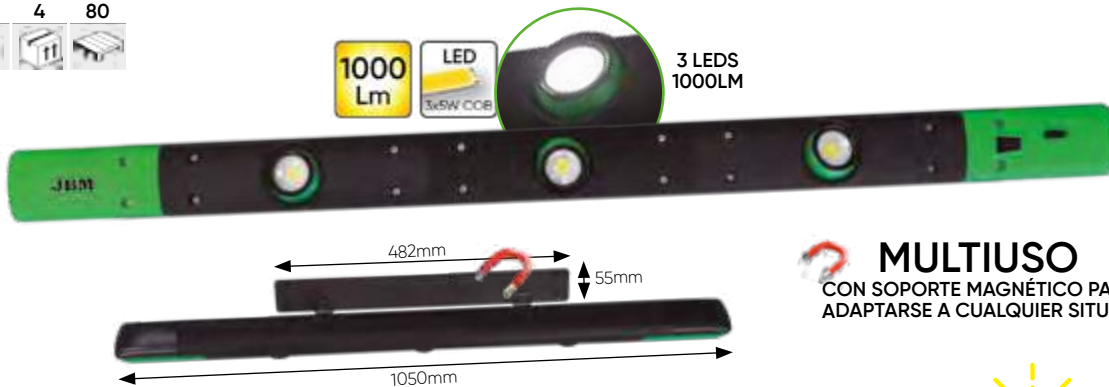

**MULTIUSO**  
CON SOPORTE MAGNÉTICO PARA ADAPTARSE A CUALQUIER SITUACIÓN

**3 MODOS DE LUZ**

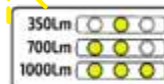

PERMITE DIRIGIR EL FOCO DE LUZ INDIVIDUALMENTE DONDE SE PRECISE



LUCES INDICADORAS DEL ESTADO DE LA BATERÍA

BATERÍA RECARGABLE



AUMENTAN NOTABLEMENTE LA VISIBILIDAD EN LA ZONA DE TRABAJO.

## BARRA LED PARA CAPÓ CON BRAZOS EXTENSIBLES

53570

2,7 4 48

154,00€



1000 Lm

LED 3x5W COB

3 LEDS 1000LM

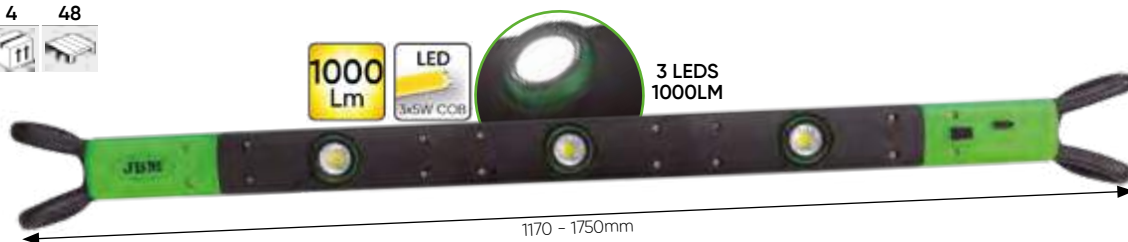
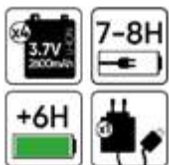

**3 MODOS DE LUZ**



BRAZOS EXTENSIBLES DE 1170MM A 1750MM



PERMITE DIRIGIR EL FOCO DE LUZ INDIVIDUALMENTE DONDE SE PRECISE



LUCES INDICADORAS DEL ESTADO DE LA BATERÍA

BATERÍA RECARGABLE



AUMENTAN NOTABLEMENTE LA VISIBILIDAD EN LA ZONA DE TRABAJO



## TOMAS DE MECHERO Y TRANSFORMADOR

REF.	DESCRIPCIÓN	PARA	Icon	Icon	Icon	€
11107	TOMA DE MECHERO ENTRADA: 100-240V SALIDA: 6V 500MA	53465, 53466, 53467, 51889, 52883, 53568, 53569	0,06	1	250	4,50€
10961	TRANSFORMADOR DE CORRIENTE ENTRADA: 100-240V SALIDA: 6V 500MA	53465, 53466, 53467, 51889, 52883, 53568, 53569	0,08	-	150	13,00€
11989	TOMA DE MECHERO ENTRADA: 100-240V SALIDA: 9V 500MA	52536	0,04	-	200	2,00€
11093	TOMA DE MECHERO ENTRADA: 230V SALIDA: 6V 500MA	52002	0,06	-	250	4,00€
14031	ADAPTADOR USB PARA ENCHUFE DE PARED ENTRADA: 100-240V SALIDA: 5V 1000mA	53465, 53466, 53467, 53216, 53217, 53519, 52987, 52883, 53530, 53451, 53199, 53570, 53707, 53439, 53568, 53569	0,1	10	100	10,00€
13839	ADAPTADOR USB PARA ENCHUFE DE PARED 110V/60HZ	53465, 53466, 53467, 53216, 53217, 53519, 52987, 52883, 53530, 53451, 53199, 53570, 53707, 53439, 53568, 53569	0,04	-	200	8,50€
14032	ADAPTADOR USB PARA TOMA DE MECHERO ENTRADA: 12-24V SALIDA: 5V, 1A/2.1A	53465, 53466, 53467, 53216, 53217, 53519, 52987, 52883, 53530, 53451, 53199, 53570, 53707, 53439, 53568, 53569	0,1	10	100	12,00€
13815	ADAPTADOR USB PARA TOMA DE MECHERO ENTRADA: 12-24V SALIDA: 5V 1000mA	53465, 53466, 53467, 53216, 53217, 53519, 52987, 52883, 53530, 53451, 53199, 53570, 53707, 53439, 53568, 53569	0,1	10	100	8,50€
14033	CABLE USB LONGITUD: 80CM	53216, 53217, 53519, 52987, 53530, 53451, 53199, 53570, 53707, 53499	0,1	10	100	4,50€





# LÁMPARA LED INDUSTRIAL

**54039**

2,60 1 12  
Kg fl

154,00€

Ø :50cm x 38cm

Este artículo está especialmente diseñado para la iluminación de ambientes industriales, talleres y espacios de gran altura.

- Peso ligero
- Potencia: 200W
- Flujo luminoso: 20000Lm
- Diámetro: 50cm x 38cm
- Grado de protección: IP20
- LED: MTC
- Driver: Meanwell
- Temperatura de color: 6500k
- Frecuencia: 50/ 60 Hz

20.000Lm

200W 50-60Hz 220V

RECAMBIO CAMPANAS

**15385**

50  
fl

18,00€



# FOCO LED DE 50W

**53505**

2,25 8 96  
Kg fl

64,00€

3.500 Lm x60 LED  
50W 230V 50Hz IP 65  
+25.000h 6500 KELVIN 70M 2m



# TRÍPODE PARA FOCO LED REF. 53505

**53506**

36,00€

↑1.830mm  
↓840mm

Kg 2,3  
fl 8  
96



680mm



**52254**

64,00€

↑2.770mm  
↓1.290mm

Kg 3,51  
fl 1  
4  
24

CE



- Lámpara no incluida.

## ALINEADOR DE FAROS CON LUXÓMETRO

52740

624,00€

24

1

10



1560mm

520mm

280mm



HALÓGENO / XENON / LED

- Distancia de medición: 50cm.
- Fácil medición de la desviación del eje óptico de la luz de carretera y de la luz de cruce.
- También para camiones.



## ALINEADOR DE FAROS DOBLE LASER CON LUXÓMETRO

52836

1.100,00€

24,85

1

10



270mm

520mm

1560mm



- También para camiones.

HALÓGENO / XENON / LED

REGULACIÓN PANTALLA DE VERIFICACIÓN

LUXÓMETRO DIGITAL



DOBLE LÁSER



## BALIZA DE EMERGENCIA LED

53721

18,80€

0,16

20

80

1.440



HOMOLOGADA: DGT LCOE 2019050378G1

ÚTIL ANTE CUALQUIER SITUACIÓN

- Resistente al viento **180 Pa**.
- Resistente al agua **IP 54**.
- Resistente al polvo.
- Temperatura de trabajo: **-20°C a 50°C**.

CON GRAN VISIBILIDAD

- **24 LED de 0,5W** (luz naranja) + **9 LED de 0,2W** (luz blanca).
- Intensidad de luz: **40-80 CD**.
- Frecuencia: **0,82 Hz**.
- Ángulo superior: **-8° a 8°**.

MODOS DE LUZ

- Incluye 2 modos de luz: **destello de emergencia naranja** + función de **iluminación con luz blanca**.

SIN CABLE

- Incluye pila **6LR61 de 9V**.
- **Tiempo de trabajo:** FLASH naranja (24 horas). LUZ blanca (5 horas).



x9 LED  
1.8W  
5H

x24 LED  
12W  
24H

indicador de estado de batería



Magnético



Amplia visibilidad



Pequeño, ligero y fácil de manejar

BASE IMANTADA



40-80 cd

180Pa

IP 54

0.82Hz

-8° a 8°

ABS

-20°C a 50°C

9V 450mA

ABS

6500±400 KELVIN

1700±200 KELVIN

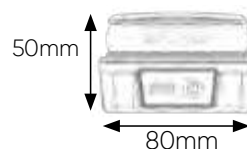

Presentación en expositor de 20 uds





## GIROFARO LED BASE FLEXIBLE

**52456**

32,75€

0,59 20 160



- Lente ABS-BAES.
- Tulipa anti-rotura.
- Consumo: 8W.

- Funciones:
- Función 1: ROTACIÓN
- Función 2: DOBLE DESTELLO
- Función 3: 6 DESTELLOS



## GIROFARO LED 12-24V BASE FLEXIBLE

**53690**

32,85€

0,60 20 200



- Funciones:
- Función 1: DESTELLO
- Función 2: DOBLE DESTELLO
- Función 3: ROTACIÓN



## GIROFARO LED MAGNÉTICO

**53691**

32,85€

0,70 20 320



- Funciones:
- Función 1: DESTELLO
- Función 2: DOBLE DESTELLO
- Función 3: ROTACIÓN



## GIROFARO SIN CABLE

**51962**

23,00€

0,58 20 240



12V  
55W

- Lente ABS - BAES.
- Tulipas anti-rotura.
- Hilo de la lente con sellado duradero.
- Rpm: 40.
- Sistema de piñón / Sinfin.
- Bombilla:
- H1, 12V 55W
- H1, 24V 70W
- Consumo corriente: 3.0 A.

**51963**

27,00€

0,59 20 240



24V  
70W

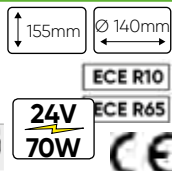

## GIROFARO BASE FLEXIBLE

**51964**

26,50€

0,69 20 160



12V  
55W

- Lente ABS - BAES.
- Tulipas anti-rotura.
- Hilo de la lente con sellado duradero.
- Rpm: 40.
- Sistema de piñón / Sinfin.
- Bombilla:
- H1, 12V 55W
- H1, 24V 70W
- Con base de rosca.
- Consumo corriente: 3.0 A.

**51965**

27,50€

0,68 20 160



24V  
70W

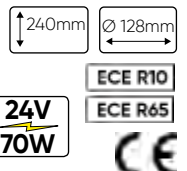

## FARO DESTELLANTE

51966

18,00€

0,31 50 750  
Kg fl

12V  
110V

- Lente ABS - BAES.
- XENON.
- Consumo corriente: 3.0 A.

131mm

Ø 99mm Ø 61mm

BASE TULIPA  
ROSCADA



ECE R10

## GIROFARO DESTELLANTE ROTATIVO LED PERFIL BAJO

52827

45,50€

52910

39,00€

52946

41,50€

52828

42,50€



0,44 20 320  
Kg fl

- Con 3 interruptores de función.
- 3 modos intermitentes:  
ROTATIVO  
6 DESTELLOS  
MODO DUAL FLASH



12V  
24V  
95mm  
129mm  
PC  
4m

CE ECE R10



## GIROFARO CON CABLE IMANTADO

51960

29,80€

0,80 20 240  
Kg fl

12V  
55W



170mm  
Ø 140mm

51961

29,80€

0,78 20 240  
Kg fl

24V  
70W

- Lente ABS - BAES.
- Tulipas anti-rotura.
- Hiló de la lente con sellado duradero.
- Rpm: 40.
- Sistema de piñón / Sinfin.
- Bombilla:  
H1, 12V 55W  
H1, 24V 70W
- Cable: Espiral de 3m + toma de mechero.
- Consumo corriente: 3.0 A.



ECE R10  
ECE R65 CE

## GIROFARO DESTELLANTE DE LED

52375

35,25€

0,68 20 240  
Kg fl

12-24V

- Lente ABS-BAES.
- Tulipa anti-rotura.
- Cable: Espiral de 2,5m + toma mechero.
- Consumo: 9W.

- Funciones:  
Función 1: ROTACIÓN  
Función 2: DOBLE DESTELLO  
Función 3: 6 DESTELLOS

170mm  
Ø 140mm

CE ECE R10

LED 6 EN 1



## CONECTORES DE ASTA PARA GIROFARO

PARA REF. 51964, 51965,  
52300, 52456, 52549, 53131

10750

13,00€

0,25 50  
Kg fl

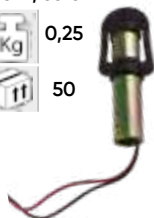

PARA REF. 51964, 51965,  
52300, 52456, 52549, 53131

10751

15,00€

0,33 50  
Kg fl

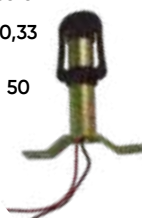

PARA REF. 51966

11103

5,50€

0,01 1  
Kg fl



PARA REF. 51960, 51962, 51964

10766

2,80€

0,02 10 200  
Kg fl



## BARRA EXTENSIBLE PARA GIROFARO

52843

27,00€

1,03 20 1.500  
Kg fl

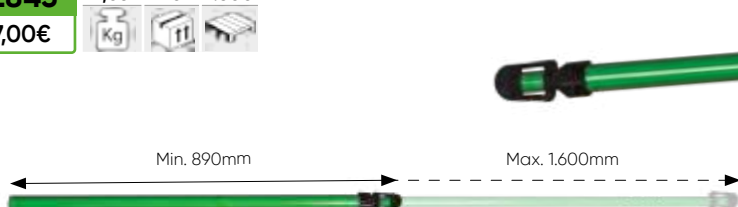



## CAPARAZÓN DE GIROFARO PARA REF. 51960, 51962, 51964

**51969** 0,12 50  
14,00€

**11324** 0,13 50  
17,50€

**11325** 0,12 50  
17,50€

TULIPAS ANTI-ROTURA



## AVISADOR ACÚSTICO 12V - 80V

**51967** 0,3 10 50 1.200  
15,80€

80mm 113mm 50mm

**51968** 0,23 10 50 1.000  
15,80€

80mm 113mm 50mm



51967

51968

- 97 dB.
- Resistente a distintas condiciones climáticas.
- Posibilidad de lavarlo con agua a presión.

- Protegido frente a polaridades inversas.
- Sellado con resinas ipoxy.
- Temperaturas soportadas: de -30 a 70°C.



## LUZ DE SEGURIDAD PARA CARRETILLA ELEVADORA

**53516** 0,7 20 300  
59,00€

10V 30V 10W

**54078** 0,7 20 300  
64,50€

10V 60V 15W



Luz oval de seguridad con 2 leds azules. Se proyecta sobre el terreno con una luz concentrada azul a modo de advertencia para los peatones de la zona.

Esta luz de alerta permite evitar colisiones y accidentes entre carretillas elevadoras y personas, y aumenta la seguridad en el entorno de trabajo, especialmente en puntos ciegos. Perfecto para ambientes ruidosos.

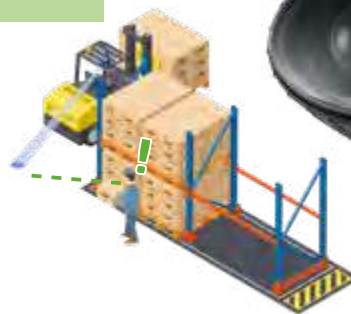

Soporte universal



## FARO DE TRABAJO LUZ DISPERSA

**53428** 0,5 5 20 480  
14,00€

126mm 108mm 48mm

**53429** 0,4 5 20 480  
14,00€

128mm Ø115mm 48mm

1.800 Lm 9V 30V x9 LED 27W LED IP 67 6000 KELVIN AL



## FARO DE TRABAJO LED LUZ DISPERSA

**52566** 1,09 10 360       

23,95€

**52567** 1,02 10 400       

23,95€

## FARO DE TRABAJO LED LUZ CONCENTRADA

**52568** 1,17 10 400       

23,95€

**52569** 1,04 10 400       

23,95€

**1.450 Lm**    
**10V 40V**    
**AI** 



**1.450 Lm**    
**10V 40V**    
**AI** 



## FARO DE TRABAJO LED LUZ DISPERSA

**52302** 0,84 5 20 640       

19,60€

**52303** 0,76 5 20 640       

19,60€

**1.450 Lm**    
**AI**    
**IP 68** 



## FARO DE TRABAJO LED LUZ CONCENTRADA

**52415** 0,84 5 20 640       

15,90€





**52414** 0,76 5 20 640       

15,90€









**1.450 Lm**    
**10V 40V**    
**IP 68** 



## FARO DE TRABAJO LED LUZ CONCENTRADA





**53051** 2,75 6 468    

136,40€









    
**7.200 Lm**    
**AI**    



## FARO DE TRABAJO LED LUZ DISPERSA

**53052** 2,75 6 468    

136,40€

    
**7.200 Lm**    
**AI**    





## FARO DE TRABAJO LED LUZ CONCENTRADA

**53048** 1,5 10 1.000  
78,60€ Kg ft

118mm 123mm 87mm

3.600 Lm x4 LED 10W

AI 9-36V 40W IP 68 +30.000h



## FARO DE TRABAJO LED REGULABLE LUZ CONCENTRADA

**53047** 3,51 4 40  
265,35€ Kg ft

230mm 185mm 150mm

3.200 Lm x10 LED 5W  
AI 12-24V 80W IP 67  
+30.000h 280cm



## FARO DE TRABAJO LED LUZ DISPERSA

**53049** 1,53 10 468  
78,60€ Kg ft

118mm 123mm 87mm

3.600 Lm x4 LED 10W

AI 9-36V 40W IP 68 +30.000h



DISTANCIA REMOTA 100M



VELOCIDAD AJUSTABLE DE MOVIMIENTO



GIRATORIO

## FARO DE TRABAJO LED LUZ DISPERSA

**53045** 1 12 504  
35,00€ Kg ft

155mm 127mm 55mm

2.880 Lm x16 LED 3W

AI 9-36V 46W IP 68 +30.000h



## FARO DE TRABAJO LED LUZ DISPERSA

**53046** 0,74 12 480  
34,00€ Kg ft

139mm 128mm 48,5mm

2.272 Lm x16 LED 1,5W AI  
9-36V 24W IP 68 +30.000h



## KIT MAGNÉTICO 2 PILOTOS LED INALÁMBRICOS

**54044** 1,1 6  
88,00€ Kg ft

WIRELESS

2.4 GHz -10°C 50°C IP65 Transmisor de Radio Inalámbrico 20m

2-3H 10H 7 PINS



## BARRA TELESCÓPICA PARA REMOLQUE DE 1,4 a 2,1M - 6M CABLE

**52458**

53,35€



**7 PINS**



6M

**52848**

75,60€



6M

Homologado E4 7R-0218756

## PILOTO LED PARA BARRA DE REMOLQUE

**53151**

12,50€



**12V**



- 4 funciones:
- Azul: Posición y matrícula.
- Rojo: Luz de freno.
- Amarillo: Intermitente.
- Blanco: Masa.

## BARRA PARA REMOLQUE CON 2 PILOTOS Y 2 CATAREFLECTANTES TRIANGULARES, CABLE DE 5m

**50910**

45,00€



**52838**

56,00€



LED

Homologado E4 7R-0218756

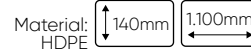

Material: HDPE

**7 PINS**



50910

52838

52838

## KITS MAGNÉTICO CON 2 PILOTOS Y 2 CATAREFLECTANTES

**51886**

44,00€



**52839**

57,00€



LED

Homologado E4-7R-0218756

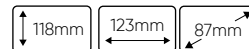

Cable liso: 7m  
Cable de espiral: 2,5m

**7 PINS**



## COMPROBADOR DE LUCES DE REMOLQUE 7/13 PINS

**53536**

28,05€



**7-13 pins**

**9V**



ALARGADOR  
7 PINS

**14753**

13,00€

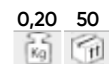

- Este comprobador tiene una toma de 13 pins en cada extremo para ser conectada al enchufe del remolque y en el otro para conectar el enchufe de 7 polos del vehículo.
- Indica rápidamente si hay daños en el cableado tanto del coche como del remolque.
- También útil para la comprobación de caravanas y soportes

- para bicicletas.
- Dispone de dos salidas, una para la toma de salida del vehículo u otra para la toma de entrada del remolque.
- Incluye un adaptador de 13 a 7 pins.
- PILA 9V.

13 PINS

7 PINS



- Incluye clavija de 7 pins y enchufe de 7 pins
- Medida cable: 20cm x 0,5mm<sup>2</sup>

## COMPROBADOR DE LUCES DE REMOLQUE 7 PINS

**51929**

21,00€



**7 pins**

**9V**



- Este comprobador tiene una toma en un costado para conectar el enchufe de 7 polos del remolque y en el otro para conectar el enchufe de 7 polos del vehículo.
- Indica rápidamente si hay daños en el cableado tanto del coche como del remolque.
- También útil para la comprobación de caravanas y soportes para bicicletas.

- Dispone de dos salidas, una para la toma de salida del vehículo y otra para la toma de entrada del remolque.

TOMA  
REMOLQUE

TOMA  
VEHÍCULO





## MINI ESTUCHE DE LÁMPARAS

0,09 10 100 1.800  
Kg u.s. fl

12V H9



**51615**  
6,80€

12V

12V H11



**51612**  
6,80€

12V

12 V HB3



**50523**  
4,50€

12V

12V HB4



**50524**  
4,50€

12V

12V H7+H1



**50915**  
5,40€

12V

12 V H1



**51613**  
3,80€

12V

H4



**51614**  
4,50€

12V

**52047**  
4,50€

24V

H7



**50431**  
4,80€

12V

**52048**  
5,00€

24V

## ARMARIO DE LÁMPARAS PARA TURISMO

**50551**

9,39 1 18

**330,00€**

Kg fl

### Stop de 1 Polo

P21W 21 W BA15s 30u.  
P21WA 21 W BA15s Ambar / 10u.  
PY21W 21 W BAU15s  
Con desc. / 10u.

### Stop de 2 Polos

R21/5 W 21/5 W BAY15d 40u.  
PLAFONIER  
C5W 5 W SV8.5 11x38 22u.

### Lámparas Piloto

R5W 5 W BA15s 30u.  
R10W 10 W BA15s 30u.

### Lámparas indicadoras

T4W 4 W BA9s 22u.

### Lámparas Halógenas

H1 55 W P14.5s 10u.  
H2 55 W X511 4u.  
H3 55 W PK22s 4u.  
H4 60/55 W P43t 10u.  
H7 55 W PX26d 10u.  
HB3 65 W P20d 4u.  
HB4 55 W P20d 4u.  
H9 65 W PGJ19-5 4u.  
H11 65 W PGJ19-2 4u.

### Foco Europeo

T5 12 W W2,1x4,6d 20u.  
T10 5 W W2,1x9,6d 12u.  
T10 3 W W2,1x9,6d 12u.  
T13 10 W W2,1x9,6d 10u.  
T15 18 W W2,1x9,6d 10u.  
T20 21 W W5x16d 10u.  
T20A 21 W W5x16d Ambar 10u.  
T20 21/5 W W5x16d 10u.

560mm

605mm



## H7

**52365** 0,01 10 200 9.000

3,42€    

**12V** - Empaque: Caja 1pcs  
**55W**

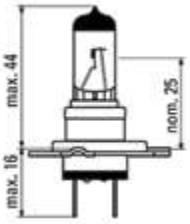

## H4

**52364** 0,02 10 200 4.400

3,92€    

**12V** - Empaque: Caja 1pcs  
**60-55W**

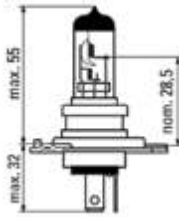

## H1

**52362** 0,01 10 200 14.400

1,68€    

**12V** - Empaque: Caja 1pcs  
**55W**

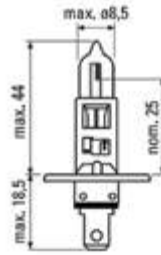

## BA15S

**53203** 0,1 10 200

0,50€     **ÁMBAR**

**12V**  
**21W**

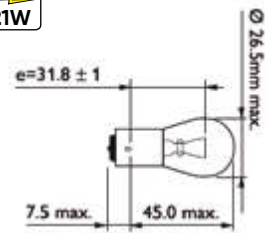

## H1 55W

**10766** 0,02 10 200

2,80€   

**12V** - Empaque: Caja 1pcs  
**55W**

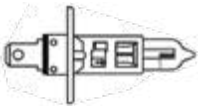

## H3

**52363** 0,02 10 200 14.400

1,68€    

**12V** - Empaque: Caja 1pcs  
**55W**

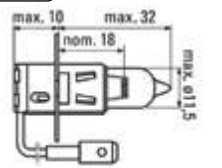

## 1 POLO

**52366** 0,01 10 200 14.400

0,57€    

**12V** - Empaque: Caja 10pcs  
**21W** - Casquillo BA15s

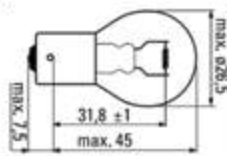

## 2 POLOS

**52367** 0,01 10 200 14.400

0,57€    

**12V** - Empaque: Caja 10pcs  
**21/5W** - Casquillo BAY15d

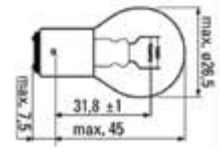

## 2 POLOS

**52369** 0,01 10 1.000 18.000

1,62€    

**12V** - Empaque: Caja 10pcs.  
**21-55W** - Sin casquillo T20

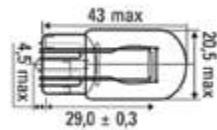

## PLAFONIER

**52371** 0,01 10 2.000 24.400

0,50€    

**12V** - Empaque: Caja 10pcs  
**5W** - Casquillo SV8,3 11x31

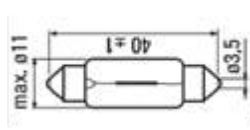

## WEDGE T10

**52861** 0,01 10 5.000

0,50€    

**12V** - Empaque: Caja 10pcs  
**5W** - W2,1x9,5d

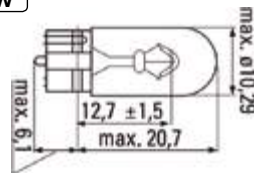

## WEDGE T20

**52862** 0,01 10 1.000

1,80€    

**12V** - Empaque: Caja 10pcs  
**21W** - W3x16d

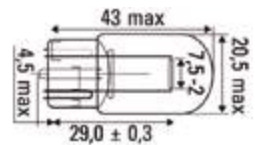

## WEDGE T20

**52863** 0,01 10 1.000 **ÁMBAR**

1,80€    

**12V** - Empaque: Caja 10pcs  
**21W** - WX3x16d

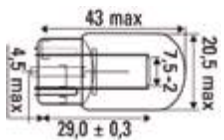

## R5W

**53007** 0,01 10 200

0,50€    

**5V** - Empaque: Caja 10pcs  
**12W** - Casquillo BA15S

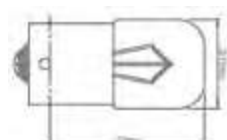

## BAU15S

**52867** 0,01 10 1.000 **ÁMBAR**

1,00€    

**12V** - Empaque: Caja 10pcs  
**21W** - Casquillo BAU15s

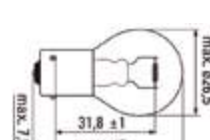

## T20A

**52368** 0,01 10 1.000 18.000

1,56€    

**12V** - Empaque: Caja 10pcs.  
**21W** - Sin Casquillo

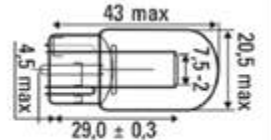

## T20

**52370** 0,01 10 1.000 18.000

1,59€     **ÁMBAR**

**12V** - Empaque: Caja 10pcs.  
**21W** - Sin Casquillo

- Empaque: Caja 10pcs.  
- Sin Casquillo

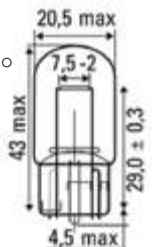

## T20

**52864** 0,01 10 1.000

1,80€    

**12V** - Empaque: Caja 10pcs  
**21/5W** - W3x16q

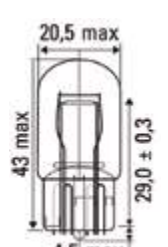

## T13

**52865** 0,01 10 2.000

0,50€    

**12V** - Empaque: Caja 10pcs  
**10W** - Sin casquillo

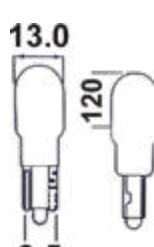

## T15

**52866** 0,01 10 2.000

0,50€    

**12V** - Empaque: Caja 10pcs  
**18W** - Casquillo

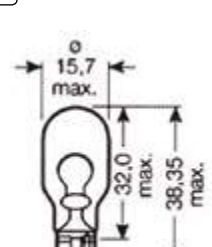



PISTOLAS DE IMPACTO 132-138-142



PARA CAMIONES 134



TALADRO 135-139-143



AMOLADORAS 135-137-139-143



CARRACAS 135-142



CORTADORA 135-139-14



LIJADORA 141



PULIDORAS 141



DESTALONADOR DE LLANTAS / ESMIRILADOR DE VÁLVULAS 140



DISCOS / EXPOSITORES 144



PISTOLAS DE AIRE 145



FILTROS / ACEITES LUBRICANTES 146



PISTOLAS VARIAS 147



CARRETES MANGUERA DE AIRE 148



MANGUERAS DE AIRE 149



CONNECTORES / ADAPTADORES / ENGANCHES 149



# HERRAMIENTAS NEUMÁTICAS



**SERIE124**

## PISTOLA IMPACTO 1/2" COMPOSITE

**53520**

228,00€

2,4 5 10 160



- Con Torsión controlada.



**1756Nm**

COMPOSITE



SET DE REPARACIÓN  
PARA PISTOLA 53520

**14121**

26,00€

0,75 20



## PISTOLA DE IMPACTO NANO 1/2"

**53588**

152,00€

1,65 5 270



**1302Nm**



SET DE REPARACIÓN PARA  
PISTOLA 53588

**14165**

26,50€

0,05 10



## PISTOLA DE IMPACTO DE 1/2" COMPOSITE

**51206**

209,00€

1,46 5 10 150



**1302Nm**

COMPOSITE



SET DE REPARACIÓN  
PARA PISTOLA 51206

**14120**

22,00€

0,15 5



## KIT PISTOLA DE IMPACTO DE 1/2" COMPOSITE + VASOS

**51207**

264,00€

3,95 5 80



COMPOSITE

**1756Nm**



17, 19, 21mm



SET DE REPARACIÓN  
PARA PISTOLA 51207

**14121**

26,00€

0,75 20





## PISTOLA DE IMPACTO DE 3/4" COMPOSITE

**51212** 3,77 4 60  
448,00€

**2034Nm**

COMPOSITE



SET DE REPARACIÓN PARA PISTOLA 51212

**14122** 1,12 20  
34,00€



## PISTOLA DE IMPACTO DE 1" COMPOSITE

**51211** 3,86 4 60  
498,00€

**2034Nm**

COMPOSITE



SET DE REPARACIÓN PARA PISTOLA 51211

**14123** 1,16 20  
33,00€



## PISTOLA DE IMPACTO DE 3/4" + ALARGADOR 15cm COMPOSITE

**51210** 4,49 4 60  
560,00€

**2034Nm**

COMPOSITE

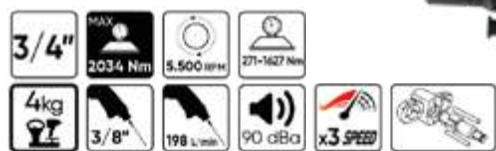

SET DE REPARACIÓN PARA PISTOLA 51210

**14122** 1,12 20  
34,00€



## PISTOLA DE IMPACTO DE 1" + EXTENSOR 19cm COMPOSITE

**51213** 4,77 4 60  
599,00€

**2034Nm**

COMPOSITE



SET DE REPARACIÓN PARA PISTOLA 51213

**14123** 1,16 20  
33,00€

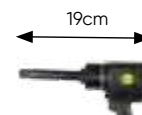

## PISTOLA DE IMPACTO 1/2" COMPOSITE

**53689** 2,10 5 10 140  
230,00€

**1950Nm**

COMPOSITE

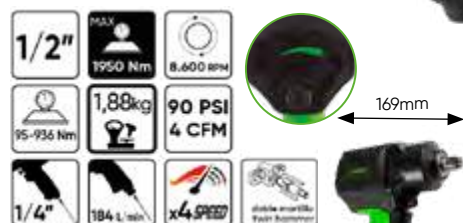

SET DE REPARACIÓN PARA PISTOLA 53689

**14618** 0,05 20  
19,00€



VELOCIDAD Y POTENCIA REGULABLES CON UNA SOLA MANO

## PISTOLA DE IMPACTO 1/2"

**53726** 2,35 10 240  
118,00€

**1650Nm**

COMPOSITE



JBM RECOMIENDA EL USO DE SUS ACEITES LUBRICANTES PARA OPTIMIZAR EL RENDIMIENTO Y ALARGAR LA VIDA ÚTIL DE LA HERRAMIENTA

VER PÁG.146

**14534**  
600ML



**14560**  
100ML



## PISTOLA DE IMPACTO ANGULAR 1/2"

**53733**

1,30 5 10

227,00€



**650Nm**



SET DE REPARACIÓN  
PARA PISTOLA 53733

**14633**

0,75 20

22,50€



## PISTOLA DE IMPACTO 1/2"

**53608**

2,35 5 10 300

88,00€



**1200Nm**



SET DE REPARACIÓN  
PARA PISTOLA 53608

**14583**

0,05 10

6,00€



## PISTOLA NEUMÁTICA PARA RUEDA DE CAMIÓN 1"

**52814**

23,5 1 20

528,00€



- Escape: lateral.  
- Fácil regulación de la velocidad de apriete y desapriete.

**3260Nm**



SET DE REPARACIÓN  
PARA PISTOLA 52814

**14153**

0,1 10

20,50€



## PISTOLA DE IMPACTO PARA CAMIONES 1" - ULTRALIGERA

**53681**

7,98 2 50

742,50€



**2441Nm**



SET DE REPARACIÓN  
PARA PISTOLA 53681

**14336**

1,17 10 10

58,00€





## TALADRO EN ÁNGULO DE 90° 3/8"

**51221** 1,27 10 120  
178,00€

- Reversible por ambos lados.
- Acabado en goma.



SET DE REPARACIÓN  
PARA PISTOLA 51221

**14130** 0,01 10  
21,00€



## MINI AMOLADORA DE 3/8" 6mm

**51245** 0,60 5 20 240  
99,00€



SET DE REPARACIÓN  
PARA PISTOLA 51245

**14135** 0,01 10  
12,50€



## KIT CARRACA MULTIFUNCIÓN DE 1/4" CON CABEZAL ABIERTO COMPOSITE

**51225** 0,89 10 120 COMPOSITE **40,7Nm**  
198,00€

- Kit incluye:  
Convertidor de 1/4" a 3/8".  
Cabezal para Puntas de 1/4".  
Set 2 puntas planas + 2 Puntas  
estrella.



SET DE REPARACIÓN  
PARA PISTOLA 51225

**14132** 0,01 10  
21,50€



## TALADRO REVERSIBLE 1/2" COMPOSITE

**51220** 1,64 10 120  
210,00€

- Reversible por  
ambos lados.



COMPOSITE



SET DE REPARACIÓN  
PARA PISTOLA 51220

0,01 10 **14129**  
12,50€



## CARRACA MINI DE 1/2" COMPOSITE

**53784** 0,55 5 20  
144,00€

COMPOSITE



SET DE REPARACIÓN  
PARA PISTOLA 53784

**14779** 0,05 10  
33,00€



## CARRACA MINI DE 1/4" COMPOSITE

**51214** 0,52 20 240  
138,00€

COMPOSITE



SET DE REPARACIÓN  
PARA PISTOLA 51214

**14124** 0,25 10  
20,50€



JBM RECOMIENDA EL USO DE SUS ACEITES LUBRICANTES  
PARA OPTIMIZAR EL RENDIMIENTO Y  
ALARGAR LA VIDA ÚTIL DE LA HERRAMIENTA

VER PÁG.146

**14534**  
600ML



**14560**  
100ML



## CARRACA DE 1/2"

51215

1,33 20 240

99,00€

Kg fl

- Rotación de aire de admisión y escape.
- Rodamiento a bolas.
- Regulador de Aire.



SET DE REPARACIÓN PARA PISTOLA 51215

14125

0,33 10

19,50€

Kg fl

## KIT CORTADOR NEUMÁTICO CON SALIDA TRASERA

51227

2,03 10 120

193,00€

Kg fl

- Acabado en goma.
- Palanca reversible.
- Diseño MINI.
- Incluye Gafas, palancas, allen y 10 discos 3".

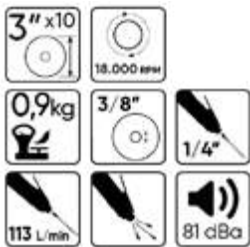

RECAMBIOS EN PÁG.144



SET DE REPARACIÓN PARA PISTOLA 51227

14134

0,01 10

17,50€

Kg fl



## KIT LIJADORA ORBITAL

51226

1,52 10 120

233,00€

Kg fl

- Acabado en goma.
- Palanca de seguridad.
- Diseño MINI.
- Incluye Gafas, palancas y discos de 2".



RECAMBIOS EN PÁG.144

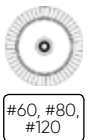

#60, #80, #120

SET DE REPARACIÓN PARA PISTOLA 51226

14133

0,01 10

16,50€

Kg fl



## HERRAMIENTA NEUMÁTICA PARA MONTAJE DE FUELLES DE PALIER

51861

4,08 1 2 32

199,00€

Kg fl

- Material: aluminio.
- Apertura de 20 a 100mm.

9 bar (125 PSI)



## CORTADORA EXTRALARGA

51219

2,1 5 10 120

221,50€

Kg fl

- Acabado en goma.
- Palanca de seguridad en 8 posiciones.

400mm

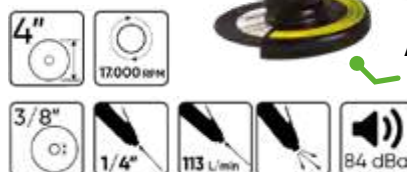

PROTECTOR ANTI CHISPAS

14128

13,50€

SET DE REPARACIÓN PARA PISTOLA 51219

0,01 10

Kg fl

Kg fl



# AMOLADORA ORBITAL COMPOSITE

COMPOSITE

**51218** 2,27 5 10 120  
**248,00€** Kg fl

- Acabado en goma.
- Mayor agarre.
- Palanca Reversible.



SET DE REPARACIÓN PARA PISTOLA 51218

**14127** 0,01 10  
**32,50€** fl

1/4" 12.000 RPM 2kg 1/4" 113 L/min 83 dBa 0,6-8mm Ø 125mm

## KIT PULIDORA

**51216** 4,33 4 16  
**548,00€** Kg fl 3.500 RPM 1/4" 83 dBa



19 PCS

- Protección de Usuario de desechos / chispas.
- Adaptor (patentado).
- Mango anatómico.
- Seguridad en Acelerador de palanca.

- Incluye:  
 Distintos tipos de ruedas (para la preparación de superficies metálicas previo a la remediación de trabajo).  
 11Mm - cepillo de alambre (fino).  
 23Mm - cepillo de alambre (fino).  
 11Mm - cepillo de alambre (grueso).  
 23Mm - cepillo de alambre (grueso).  
 Borrador de goma.

Borrador de pinturas con base de agua.  
 Adaptor de 23mm para borrador de goma y cepillo de alambre.  
 Adaptor de 11mm cepillo de alambre.  
 Pulidor negro de caucho (hasta 6 piezas).  
 Adaptor único de pulidor caucho.  
 Adaptador de doble tira de caucho.  
 Allen.

## ACCESORIOS

ADAPTADORES 25,00€/u.

Para rueda de 23mm

**51439** 0,12 50 800  
 Kg fl

Para rueda de 11mm

**51440** 0,1 1 800  
 Kg fl

Rueda negra doble

**51441** 0,1 1 800  
 Kg fl

Rueda negra simple

**51442** 0,1 1 800  
 Kg fl

CEPILLOS 18,00€/u.

Grueso ángulo de 23mm

**51388** 0,08 100 800  
 Kg fl

Grueso ángulo de 11mm

**51389** 0,05 1 800  
 Kg fl

Fino plano de 23mm

**51390** 0,01 1 800  
 Kg fl

Fino plano de 11mm

**51391** 0,04 1 800  
 Kg fl

RUEDAS RASCADORAS

25,00€/u.

**51392** 0,1 1 800  
 Kg fl

Cepillo - rueda rascador de pintura Ø105mm

**51393** Cepillo rascador de pintura al agua Ø105mm

**14126**

46,50

SET DE REPARACIÓN PARA PISTOLA 51216

0,01 10 fl



MANGO ANATÓMICO

1,2kg Kg

## VENTOSA NEUMÁTICA PARA ABOLLADURAS

**52540** 4,69 3 72  
**220,50€** Kg fl

- Ventosa con martillo neumático deslizando para quitar abolladuras.
- Su diseño permite eliminar abolladuras de una manera rápida y fácil.



JBM RECOMIENDA EL USO DE SUS ACEITES LUBRICANTES PARA OPTIMIZAR EL RENDIMIENTO Y ALARGAR LA VIDA ÚTIL DE LA HERRAMIENTA VER PÁG.146

**14534** 600ML



**14560** 100ML



## PISTOLA IMPACTO 1/2"

**51222** 1,09 20 240  
121,50€

**101Nm**



SET DE REPARACIÓN PARA PISTOLA 51222

**14131** 0,01 10  
24,00€



ACCIONAMIENTO MARIPOSA

## PISTOLA DE IMPACTO DE 1/2" COMPOSITE

**52767** 2,66 10 160  
328,00€

**1492Nm**

COMPOSITE



## PISTOLA DE IMPACTO 3/4"

**53343** 7,9 2 96  
285,00€

**1600Nm**

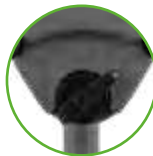

## PISTOLA DE IMPACTO 1"

**53344** 8,05 2  
295,00€

**1600Nm**

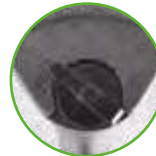

## MINI AMOLADORA 1/4" COMPOSITE

**53137** 0,55 5 20  
38,00€





## AMOLADORA ANGULAR 1/4" COMPOSITE

53141

0,55 4 60

65,50€

Kg us ft



## AMOLADORA ANGULAR NEUMÁTICA

52528

0,69 5 20 960

42,50€

Kg us ft

- Cuerpo fabricado en aluminio con recubrimiento de goma ergonómico.



GATILLO DE SEGURIDAD INCORPORADO

## SIERRA NEUMÁTICA

52574

0,73 4 20 640

64,00€

Kg us ft

- 2 Sierras recambio 95mm de 32 dientes.  
- 2 Llaves allen.  
- 1 protector de sierra.  
- Enganche rápido.



5 HOJAS DE SIERRA 24 DIENTES PARA MADERA

11956

0,03 10 300

5,50€

Kg us ft

5 HOJAS DE SIERRA 32 DIENTES PARA HIERRO

11957

0,01 200

5,50€

Kg us ft



## REMACHADORA NEUMÁTICA

52575

1,71 5 10 200

99,50€

Kg us ft

2,4mm (3/32), 3,2mm (1/8), 4,0mm (5/32), 4,8mm (3/16)

- Tracción: 1586LBS / 720 KGS.  
- Largo de varilla: 9/16" - 14mm.  
- Max. apriete 60FT LB / 23-69NM.  
- Consumo aire medio: 0,03CFM/0,86L/Min.  
- Entrada de aire: 1/4".

Contiene:  
- Cubeta trasera receptora  
- 2 Multiherramientas  
- Enganche rápido  
- Juntas tóricas



## CIZALLA NEUMÁTICA

53541

1,6 5 10

144,50€

Kg us ft

- Cizalla neumática profesional ideal para cortar aluminio, otros metales, caucho y plásticos en general, con una capacidad de corte de 1,02mm.  
- Agarre de pistola ergonómico para un uso cómodo y gatillo fácil de usar.  
- Permite cortar recto, en ángulo o en círculos sin deformación de bordes.



SET DE REPARACIÓN PARA PISTOLA 53541

14136

0,01 5

12,00€

Kg us ft



## CORTADORA NEUMÁTICA COMPOSITE

53140

0,99 14 400

95,00€

Kg us ft



RECAMBIO DISCO PARA REF. 53140

0,1 500

14013

3,50€

Kg us ft

## TALADRO NEUMÁTICO SOLDADURAS CON DESPLAZAMIENTO DE LA BROCA CENTRAL

52724

2,55 6 84

330,00€

Kg us ft

1/4"



52725

2,35 10 180

298,00€

Kg us ft

1/4"



BROCA PARA TALADRO PARA REF. 52725 Y 52724

13817

0,1 500

17,00€

Kg us ft

6,5mm

13818

0,1 500

20,50€

Kg us ft

8mm

JBM RECOMIENDA EL USO DE SUS ACEITES LUBRICANTES PARA OPTIMIZAR EL RENDIMIENTO Y ALARGAR LA VIDA ÚTIL DE LA HERRAMIENTA

VER PÁG.146

14534  
600ML



14560  
100ML



## DESTALONADOR DE LLANTAS NEUMÁTICO

53542

876,50€

6,35 4 40  
Kg fl

- Destalonador de llantas neumático profesional especialmente diseñado para su aplicación en vehículos agrícolas, industriales y en la mayoría de camiones.
- **Extremadamente rápido:** ahorra tiempo con respecto a los rompedores hidráulicos convencionales.
- Permite **desmontajes in-situ** en el lugar de trabajo de la máquina.
- Excelente para trabajar sobre el neumático **sin quitar la rueda:** afloja el talón del neumático de la llanta con apalancamiento.

ESPECIAL VEHÍCULO  
AGRÍCOLA/INDUSTRIAL



- Especificaciones técnicas:  
Capacidad de apertura: 68mm.  
Extensión del pistón: 80mm.  
Entrada de aire: 1/4".  
Consumo de aire: 113 L/min.  
Largo: 396mm.  
Peso: 4,6kg.  
10.000 RPM



SET DE REPARACIÓN PARA  
PISTOLA 53542

14137

130,50€

0,65 5 5  
Kg fl

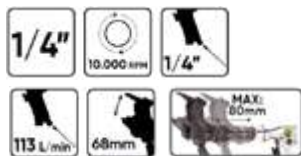

## HERRAMIENTA NEUMÁTICA PARA ESMERILAR VÁLVULAS - PERCUSIÓN Y ROTACIÓN

53572

275,00€

1,90 5 80  
Kg fl

- Contenido :  
1 x Máquina neumática para válvulas.  
5 x Adaptador de válvula.  
1 x 3 mm Llave Allen.  
5 x Ventosa (16, 20, 30, 35 y 45 mm).

REGULA LA  
VELOCIDAD



16mm

14157  
7,50€



20mm

14158  
5,00€



30mm

14159  
11,00€



35mm

14160  
6,50€



40mm

14161  
12,00€



GIRO DERECHO +  
GIRO IZQUIERDO

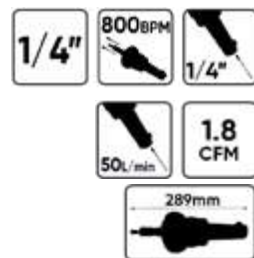

## ESMERILADOR DE VÁLVULAS PARA TALADRO

54033

49,00€

0,3 5 20  
Kg fl

- Diámetro ventosas: 16, 20, 30, 35, 40mm
- Conexión taladro: 8mm
- Longitud: 128mm
- Velocidad de trabajo máxima: 1250rpm



## PISTOLA DE SILICONA NEUMÁTICA

53567

40,00€

1 10  
Kg fl

- Presión de trabajo: 2,5-5 BAR.
- Entrada de aire: 1/4".
- Capacidad del cartucho: 310ml.



## EXTRACTOR DE HUMOS

52824

573,50€

12,5 1 6  
Kg fl

- Largo del tubo retráctil: 4m.
- Capacidad de succión: 185 L/min.

- Extractor neumático de humos, mediante conexión a compresor de aire permite su conexión directa al tubo de escape para canalizar la salida del humo.

- Útil para mantener ambientes de trabajo sanos y en determinados casos dónde el vehículo no realiza una combustión correcta y genera un exceso de humo.

- Tubo flexible retráctil, permite su almacenamiento dentro del cuerpo del extractor para ahorrar espacio de almacenamiento.





## KIT LIJADORA ORBITAL AUTO-ASPIRANTE

**52676**

93,00€

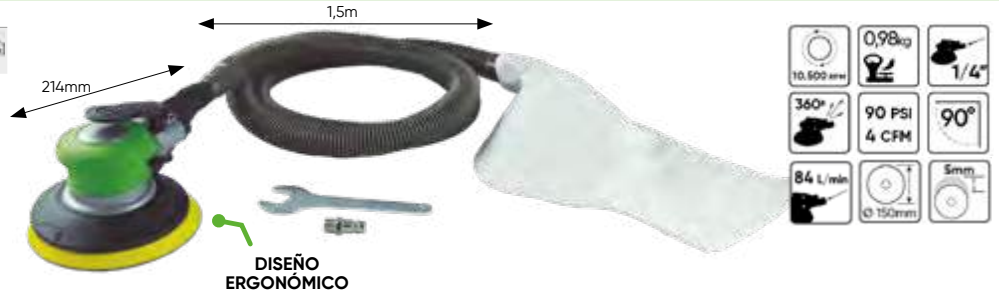

- Cuerpo de aluminio con empuñadura engomada.
- Excelente rendimiento limpieza con bolsa y manguera.

DISEÑO ERGONÓMICO



## LIJADORA ORBITAL ADAPTABLE ASPIRADOR

**52675**

79,00€



**52758**

78,00€



Cuerpo de aluminio con empuñadura engomada



## LIJADORA ORBITAL

**53136**

163,00€



## DISCOS PARA LIJADORAS



DISCO DE 6 AGUJEROS PARA 52675, 52758, 52676

**12009**

11,00€



DISCO DE 66 AGUJEROS PARA 52675, 52758, 52676

**13500**

11,00€

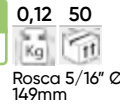

DISCO DE 15 AGUJEROS PARA 52675, 52758, 52676

**13499**

11,00€

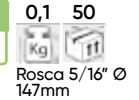

## KIT MINI PULIDORA NEUMÁTICA 3"

**53576**

189,00€



- El kit incluye:
- 1x pulidora neumática de 3".
- 1x disco de lijado de velcro (instalado).
- 1x llave para tuercas.
- 3x esponjas pulidoras con reverso de velcro.

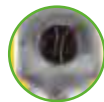

VELOCIDAD REGULABLE



ESPONJA DE LANA PARA REF. 53576

**14162** 0,05 5 50  
22,00€

ESPONJA SÓLIDA PARA REF. 53576 - AMARILLA

**14164** 0,05 5 50  
22,00€

ESPONJA BLANDA PARA 53576 - BLANCA

**14163** 0,05 5 50  
21,50€

DISCO DE VELCRO PARA REF. 53576

**14330** 0,01 5 50  
3,50€

SET DE REPARACIÓN PULIDORA

**14154** 0,05 10  
37,00€

## KIT PULIDORA NEUMÁTICA DE 3"

**53646**

61,50€



- Ideal para trabajar y pulir superficies de pintura, metal y plástico con un acabado altamente brillante.
- Su tamaño reducido permite maniobrar fácilmente accediendo a los puntos más difíciles.
- Con regulador de velocidad ajustable por gatillo.



ESPONJA NARANJA DE POLIÉTER PARA REF. 53646

**14286** 0,05 200  
3,00€

ESPONJA DENSA REF. 53646

**14287** 0,05 200  
3,00€

ESPONJA DE LANA PARA REF. 53646

**14288** 0,05 200  
5,50€

DISCO DE VELCRO PARA REF. 53646

**14289** 0,10 200  
5,00€

JBM RECOMIENDA EL USO DE SUS ACEITES LUBRICANTES PARA OPTIMIZAR EL RENDIMIENTO Y ALARGAR LA VIDA ÚTIL DE LA HERRAMIENTA

VER PÁG.146

**14534**  
600ML



**14560**  
100ML



## KIT DE PULIDO DE FAROS

53626

0,30 12 624

17,00€



Este kit está hecho para restaurar 2 faros.

- Características:  
Diseñado para restaurar la claridad de las lentes de los faros que se han vuelto amarillentas, turbias o nebulosas.  
Mejora el rendimiento de las lentes de los faros.  
Tres pasos sencillos: lijar, pulir y proteger.  
Restaura los faros delanteros, las luces traseras, los faros antiniebla o las luces direccionales.

- Contenido del kit:  
2x P800 Disco para lijar.  
2x P1200 Disco para lijar.  
2x P2000 Disco para lijar.  
1x 85g Pasta Pulidora.  
2x 3.0ml Líquido protector UV.

1x Cinta adhesiva.  
1x Disco Pulidor de Lana.  
1x Disco Esponja Blanco.  
1x Almohadilla de soporte M10 Rosca.  
2x Adaptador (3/8" & 1/4").



## SERIE ESPECIAL PULIDO: PULIDORA + 12 KIT FAROS

SERIE262

214,50€



## KIT HERRAMIENTAS NEUMÁTICAS

PISTOLA DE IMPACTO + MARTILLO NEUMÁTICO + CARRACA NEUMÁTICA + MINI PULIDORA NEUMÁTICA + PISTOLA DE SOPLADO + PISTOLA DE SOPLADO RECTA + ACCESORIOS

52331

7,79 2 48

201,50€



1x Pistola impacto 1/2"  
1x Martillo neumático 150mm  
1x Carraca neumática 3/8"  
1x Pulidora neumática  
1x Muelle de retención  
1x Barra de extensión 1/2" - 75mm  
1x Aceitera mini  
1x Llave hex. 4mm  
8x Vasos impacto: 12, 13, 17, 19, 1/2", 9/16", 5/8", 11/16"  
1x Pistola de soplado  
1x Mini pistola de soplado  
1x Cinta teflón  
4x Escarpas 120mm  
2x Llaves fijas manuales  
5x Disco de lijado 1/4"

5x Disco de lijado 1/2"  
5x Piedras de pulir 1/4"  
5x Piedra de pulir 3/8"  
2x Cilindros de lijado (3/4" y 1")  
1x Adaptador rápido hembra  
1x Conector de escarpa  
8x Tetones de soplado  
1x Conector M-M conexión rápida  
2x Collares 1/8"  
1x Conector rápido M-H  
1x Boquilla de goma  
1x Boquilla cónica  
1x Aguja de inflado  
1x Boquilla de alta presión  
1x Boquilla de seguridad  
1x Caja de plástico



## ESTUCHE 16 PIEZAS NEUMÁTICAS CON PISTOLA 312Nm Y CARRACA IMPACTO 61Nm

52156

5,36 4 112

126,50€



9, 10, 11, 13, 14, 17, 19, 22, 24, 27mm

1/2"

16 PCS

PISTOLA DE IMPACTO:



CARRACA NEUMÁTICA:  
ADAPTADOR M / H



## PISTOLA DE IMPACTO DE 1/2"

52165

2,90 6 168

105,00€



610Nm



## CARRACA NEUMÁTICA DE 1/2"

52167

1,27 5 10 700

43,50€



61Nm





## MARTILLO DE AGUJAS NEUMÁTICO

53625

2,15 5 10

- Velocidad de impacto: 4500BPM

68,00€

- 19 agujas

- Peso: 1,97kg



14188

0,50€

AGUJA RECAMBIO

PARA REF. 53625

0,01 50 200

- 0,01 kg

Recorrido: 43mm

## MARTILLO NEUMÁTICO

52718

2,11 4 8 160

48,00€

- 160 piezas



9

PCS

## TALADRO REVERSIBLE NEUMÁTICO DE 1/2"

52159

1,79 5 10 240

54,50€

- 240 piezas



## TALADRO NEUMÁTICO RECTO - 3/8" Dr.

53573

0,75 5 20

36,00€

- 20 piezas

- Compatible con brocas de 1,5-10mm.



## TALADRO REVERSIBLE NEUMÁTICO DE 3/8"

52160

1,22 5 10 360

42,00€

- 360 piezas



## TALADRO REVERSIBLE NEUMÁTICO 3/8" EN ÁNGULO DE 90°

52527

1,22 5 10 480

78,00€

- 480 piezas



## ESTUCHE DE 16 PIEZAS CON AMOLADORA NEUMÁTICA

52157

1 5 10 300

48,00€

- 300 piezas

## MINI AMOLADORA NEUMÁTICA 1/4"

52171

0,42 10 20 1.080

39,00€

- 20 piezas

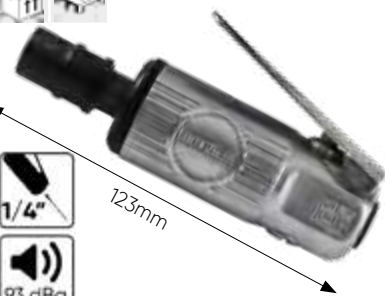

123mm

JBM RECOMIENDA EL USO DE SUS ACEITES LUBRICANTES PARA OPTIMIZAR EL RENDIMIENTO Y ALARGAR LA VIDA ÚTIL DE LA HERRAMIENTA

VER PÁG.146

14534  
600ML

14560  
100ML



## CORTADORA NEUMÁTICA DE 3"

52953

38,00€

0,9 5 20 1.500

Kg us ft



DISCO DE CORTE 3"  
PARA REF. 52953

12987

1,50€

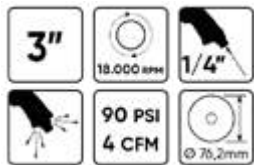

€  
0,02 50 500

Kg us ft



## DISCOS DE CORTE

PARA REF. 51227

51387

2,50€

0,02 50 100 800

Kg us ft

3"

Ø Interior: 9,53mm  
Ø Exterior: 75mm

PARA REF. 51219

51385

3,80€

0,07 25 800

Kg us ft

4"x1/32"

Ø Interior: 9,53mm  
Ø Exterior: 100mm

## DISCOS DE LIJA

PARA REF. 51218

51386

5,40€

0,1 25 800

Kg us ft



5"

Ø Interior: 22mm  
Ø Exterior: 125mm

PARA REF. 51226

51443

5,00€

0,02 25 800

Kg us ft



#60

Ø Exterior: 2"

PARA REF. 51226

51444

5,00€

0,02 25 800

Kg us ft



#80

Ø Exterior: 2"

PARA REF. 51226

51445

5,00€

0,02 25 800

Kg us ft



#120

Ø Exterior: 2"

## EXPOSITOR DE HERRAMIENTA NEUMÁTICA

53492

379,50€

13 1 7

Kg us ft

HERRAMIENTAS  
NO INCLUIDAS



## COLGADOR IMANTADO PARA HERRAMIENTA NEUMÁTICA

52378

9,50€

3Kg Ø 6cm

0,36 10 40 720

Kg us ft



52378

51341

35,00€

9Kg Ø 7cm

1,62 12 96

Kg us ft



51341

## EXPOSITOR DE HERRAMIENTAS NEUMÁTICAS

53147

41,00€

HERRAMIENTAS  
NO INCLUIDAS

1,15  
5  
10  
200

Kg us ft





## PISTOLA DE INFLADO

ANALÓGICA

**53449**

0,4 5 20 320

19,50€



0-7 BAR  
0-100 PSI

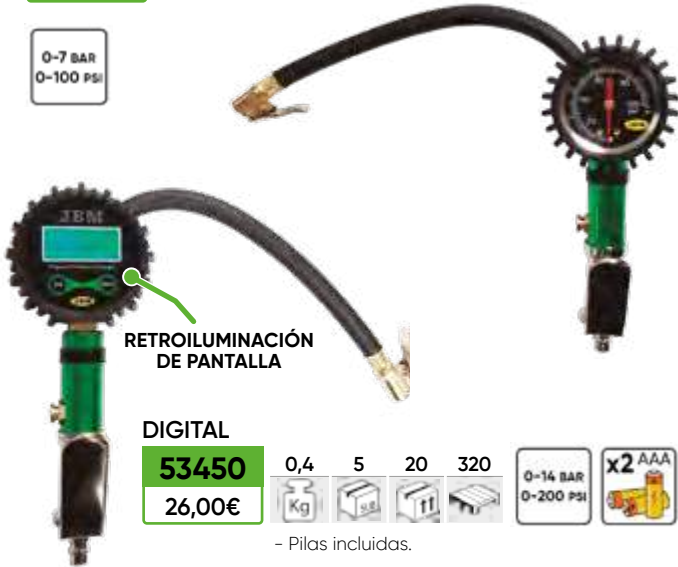

RETROILUMINACIÓN DE PANTALLA

DIGITAL

**53450**

26,00€



0-14 BAR  
0-200 PSI



- Pilas incluidas.

## PISTOLA LIMPIADORA DE FILTROS DE PARTÍCULAS

**52543**

0,84 6 96

157,00€



- Universal.
- Capacidad Máxima 650cc.
- Manguera de Nylon de 4x6x2,7m.
- Rango de presión de trabajo: 3 bar - 7 bar.
- Cuerpo inoxidable de larga duración + base de aluminio.



LÍQUIDO DESCARBONIZANTE

**90003**

35,20€



LÍQUIDO NEUTRALIZANTE

**90004**

25,80€



## PISTOLA DE AIRE + PISTOLA PARA INFLAR NEUMÁTICOS

**51981**

21,50€

0-16 BAR  
0-220 PSI



## PISTOLA DE AIRE PARA INFLAR NEUMÁTICOS

**51980**

15,00€

0-16 BAR  
0-220 PSI



## COMPROBADOR DE PRESIÓN DE NEUMÁTICOS

CON TUBO

**52648**

9,00€



5-6 bar



**53416**

13,50€



0-10 bar



DIGITAL CON TUBO

**53417**

24,00€



0-15 BAR  
0-200 PSI

0-1.500 KPA



DIGITAL

**53418**

15,50€



0-15 BAR  
0-300 PSI

0-1.500 KPA



JBM RECOMIENDA EL USO DE SUS ACEITES LUBRICANTES PARA OPTIMIZAR EL RENDIMIENTO Y ALARGAR LA VIDA ÚTIL DE LA HERRAMIENTA

VER PÁG.146

**14534**  
600ML



**14560**  
100ML



## SET DE HERRAMIENTAS DE AIRE COMPRIMIDO

**51277** 1,84 5 40  
64,00€

- 1x Pistola para pintar por gravedad con tanque de 600ml.
- 1x Inflador de neumáticos con manómetro de presión.
- 1x Pistola de aire.
- 1x Pistola de sopletear con tanque para solución de limpieza.
- 1x Manguera espiral de 5x8mm con conexión rápida 1/4" extensible hasta 4,5m.



## PISTOLA DE SOPLADO EN BLISTER

**51383** 0,27 10 50 650  
10,50€

- Pistola de aire.
- Enganche rápido europeo.
- Enganche de manguera.
- Extensor de tubo 10 cm.
- Extensor de tubo 20 cm.



EN EXPOSITOR DE 10 UNIDADES



## PISTOLA DE AIRE

**52490** 100mm  
6,50€

**52491** 300mm  
10,50€

0,12 10 40 960  
Kg ss fl

0,1 10 80 400  
Kg ss fl

## PISTOLA DE AIRE EXTENSIBLE

**52798** 0,25 10 50 700  
18,00€



285-530mm  
PUNTA RECUBIERTA DE GOMA PARA EVITAR RAYADAS



EN EXPOSITOR DE 10 UNIDADES

## PISTOLA DE AIRE EXTRALARGA

**53611** 0,50 40 160  
27,50€

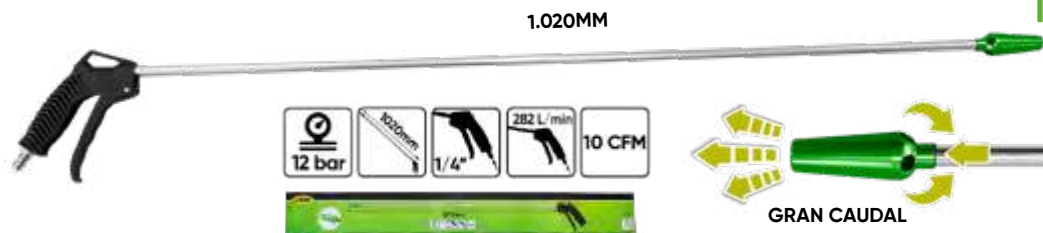

1.020MM



GRAN CAUDAL

## FILTRO Y REGULADOR DE AIRE

**53063** 0,63 5 50 1/4"  
29,00€

**53064** 0,63 5 50 3/8"  
29,00€

**53065** 0,63 5 50 1/2"  
30,00€



## FILTRO, REGULADOR DE AIRE Y LUBRICADOR

**53066** 1,08 5 25 250 1/4"  
49,50€

**53067** 1,07 5 25 250 3/8"  
48,00€

**53068** 1,06 5 25 250 1/2"  
52,00€



## CONECTOR LUBRICANTE 1/4"

**14561** 0,05 25 50 1/4"  
7,50€



## ACEITE LUBRICANTE PARA HERRAMIENTAS NEUMÁTICAS

600ml  
**14534** 0,55 12 540  
16,50€



100ml  
**14560** 0,10 12 72 1.008  
7,50€



- Densidad relativa a 15°C: 0,845.
- Viscosidad: 12,1 cSt a 40°C.
- Color: Incoloro.



## PISTOLA DE SOPLADO GRAN CAUDAL

53205

0,9 48 500

19,00€



- Pistola de soplado de gran caudal.
- Material del cuerpo: Aleación de aluminio.
- Superficie: Niquelado.



GRAN CAUDAL

## PISTOLA DE SOPLADO EN BLISTER INDIVIDUAL

52787

0,2 25 100 1.000

9,00€



## SOPLADOR DE 3/8" CON MANGUERA DE 5m

52381

0,45 5 25 200

20,50€



- Material: PU // 35 giros.



## PISTOLA DE SECADO NEUMÁTICA

53606

0,55 5 20

49,00€



VÁLVULA REGULADORA DE AIRE



## SOPORTE CON 2 PISTOLAS DE SECADO NEUMÁTICAS

53607

7,35 2 36

276,50€



360°

Permite un movimiento de 360° de la pistola así como el bloqueo de la misma en cualquier posición.



Altura ajustable hasta 208cm y ancho hasta 86cm.

- Sostiene de forma segura 2 pistolas de secado.
- Incluye 2 mangueras de aire en espiral: 8mm x 12mm x 5m.
- Cuerpo de acero con acopladores de aire de latón.
- Contiene dos pistolas de secado neumática (ref. 53606) con las siguientes características: Cuerpo de aluminio. Presión de trabajo: 2-4 bar (30-60psi). Consumo de aire: 325 l/min. Entrada de aire: 1/4". Con válvula reguladora de aire.

## PISTOLA CHORREADORA DE ARENA

53593

0,9 5 500

41,00€



- Ideal para la carrocería del coche y todo tipo de superficies metálicas: permite quitar la oxidación, la suciedad excesiva y/o el revestimiento, barniz etc. fácilmente.

- Incluye: 1x Pistola chorreadora. 1x Recogedor de arena. 2x Botes arena de 850g. 4x Casquillos: para chorreado. para chorreado en superficie. para chorreado de esquina exteriores. para chorreado de esquina interiores.



BOTELLA DE ARENA PARA REF. 53593

14168

7,00€

1 20



- Tamaño grano: 46-100MeSH 0.354-0.149mm



## PISTOLA DE PETROLEAR

53202

1,4 10 120

15,65€



- Pistola de limpieza del motor.
- Material del bote: Acero.
- Material del cuerpo: Aleación de aluminio.
- Superficie: Pintura en polvo.



900cc

Presión de trabajo Work pressure

40-120 PSI 2,7-8 BAR

Presión máxima Max. pressure

145 PSI 10 BAR

## PISTOLA DE LIMPIEZA TORNADO

53204

0,9 5 60

78,00€



- Pistola de limpieza de coches, tornado.
- Material pote: PE.
- Material del cuerpo: Aleación de aluminio.
- Superficie del cuerpo: Pulido.



## CARRETE DE MANGUERA DE AIRE 20+2m

53582

10,85

1

14

178,50€



53583

10,85

1

14

169,50€



CON SOPORTE DE PARED INCLUIDO

CON REPARTIDOR



SOPORTE DE PARED  
0,35 20

14772

8,50€

## CARRETE DE MANGUERA DE AIRE 12+1m

53532

6,7

2

30

124,00€



53581

6,7

2

30

107,50€



CON SOPORTE DE PARED INCLUIDO

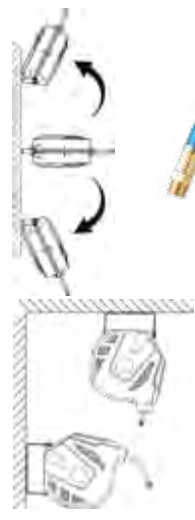

CON REPARTIDOR



SOPORTE DE PARED

0,35 10

14771

10,50€

## CARRETE DE MANGUERA DE AIRE 1/4" 10+1,5m

53881

4,50

4

48

69,00€



53882

4,50

4

48

69,00€

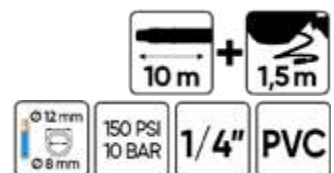

CON SOPORTE DE PARED INCLUIDO

CON REPARTIDOR





## MANGUERAS DE AIRE EN ESPIRAL

<b>10m</b> <b>53629</b> 14,00€ conector 1/4" 0,55 6 390 Kg 11 11	<b>8mm</b> <b>5mm</b>	<b>15m</b> <b>53630</b> 17,50€ conector 1/4" 0,65 6 240 Kg 11 11	<b>8mm</b> <b>5mm</b>	<b>15m</b> <b>53631</b> 31,50€ conector 1/4" 1,40 6 132 Kg 11 11	<b>12mm</b> <b>8mm</b>
<b>15m</b> <b>53632</b> 45,00€ conector 1/4" 2,20 6 78 Kg 11 11	<b>15mm</b> <b>10mm</b>	<b>15m</b> <b>53633</b> 42,50€ conector 3/8" 2,10 6 78 Kg 11 11	<b>15mm</b> <b>10mm</b>	<b>15m</b> <b>53634</b> 57,00€ conector 1/2" 2,60 6 66 Kg 11 11	<b>18mm</b> <b>13mm</b>

CON EXTREMOS GIRATORIOS DE 360 GRADOS PARA UN FÁCIL MOVIMIENTO Y FACILIDAD DE USO



- Material de la manguera: Poliuretano.  
- Material de la rosca: Latón.

## MANGUERA DE AIRE

<b>53594</b> 54,00€ Kg 11 11	<b>3,05</b> <b>4</b> <b>64</b>	<b>53595</b> 61,00€ Kg 11 11	<b>3,20</b> <b>4</b> <b>64</b>
------------------------------------	--------------------------------	------------------------------------	--------------------------------



- Presión de trabajo: 300PSI / 20bar.  
- Presión de rotura: 950PSI / 65bar.  
- Temperatura de trabajo: -40°C / 65°C

- Gran flexibilidad.  
- Regresa a su forma original.  
- Superficie suave, no daña pintura.  
- Muy resistente.



Diámetro interior: 8mm  
Diámetro exterior: 13mm

Para utilizar con:  
Ref. 52736 M8



Diámetro interior: 10mm  
Diámetro exterior: 15mm

Para utilizar con:  
Ref. 52737 M10



**25m** **300 PSI** **20 BAR**

**POLÍMERO HÍBRIDO**



x10 **BOLSA DE 10 ABRAZADERAS 8-16mm**

0,04 10 100 **14169**  
Kg 11 11 **3,00€**

## CONECTOR UNIVERSAL DE SEGURIDAD PARA MANGUERA

<b>14201</b> 4,00€ Kg 11 11	<b>14202</b> 4,00€ Kg 11 11	<b>14203</b> 4,50€ Kg 11 11	
0,1 25 100	0,1 25 100	0,1 25 100	



## CONECTOR ARTICULADO MACHO PARA AIRE COMPRIMIDO

<b>14314</b> 5,00€ Kg 11 11	<b>EUR</b> <b>1/4"</b>	<b>14315</b> 4,50€ Kg 11 11	<b>US</b> <b>1/4"</b>	
0,1 25 100		0,1 25 100		



## CONECTOR PARA MANGUERA

REF.	DESCRIPCIÓN	€
14204	EUR - M6	0,10 1,50€
14205	EUR - M8	0,10 1,50€
14206	EUR - M10	0,10 1,50€
14207	US - M6	0,10 1,50€
14208	US - M8	0,10 1,50€
14209	US - M10	0,10 1,50€

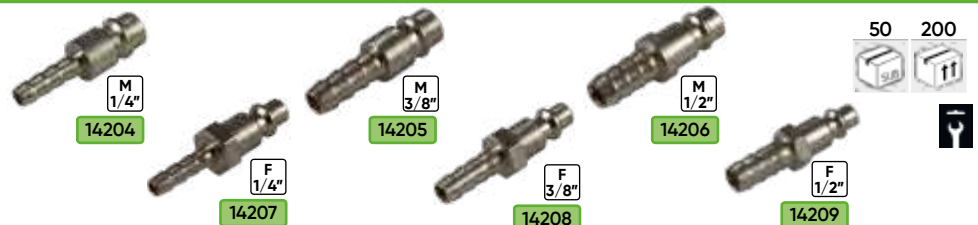

## CONECTOR DE SEGURIDAD UNIVERSAL

REF.	DESCRIPCIÓN	€
14195	CONECTOR HEMBRA - ROSCA MACHO 1/4"	0,10 4,00€
14196	CONECTOR HEMBRA - ROSCA MACHO 3/8"	0,10 4,00€
14197	CONECTOR HEMBRA - ROSCA MACHO 1/2"	0,10 4,50€
14198	CONECTOR HEMBRA - ROSCA HEMBRA 1/4"	0,10 4,00€
14199	CONECTOR HEMBRA - ROSCA HEMBRA 3/8"	0,10 4,00€
14200	CONECTOR HEMBRA - ROSCA HEMBRA 1/2"	0,10 4,50€

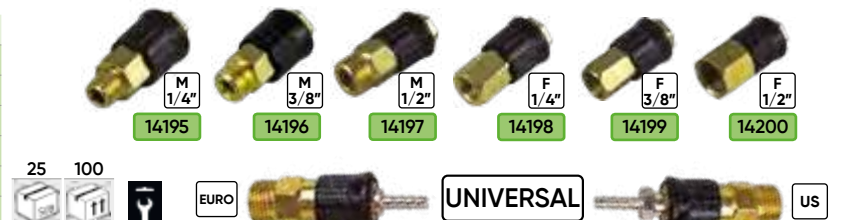

## CONECTOR / ROSCA

REF.	DESCRIPCIÓN	Paquete	€
<b>US</b>			
13930	CONECTOR MACHO - ROSCA MACHO 1/4"	0,05	1,50€
13932	CONECTOR MACHO - ROSCA MACHO 3/8"	0,1	2,50€
14076	CONECTOR MACHO - ROSCA HEMBRA 3/8"	0,1	1,50€
13933	CONECTOR MACHO - ROSCA MACHO 1/2"	0,1	2,00€
13935	CONECTOR MACHO - ROSCA HEMBRA 1/4"	0,05	2,50€
13936	CONECTOR HEMBRA - ROSCA HEMBRA 1/4"	0,05	3,50€
13937	CONECTOR HEMBRA - ROSCA MACHO 1/4"	0,05	4,00€
14078	CONECTOR HEMBRA - ROSCA HEMBRA 3/8"	0,1	4,00€
14191	CONECTOR MACHO - ROSCA HEMBRA 1/2"	0,1	2,00€
14193	CONECTOR HEMBRA - ROSCA HEMBRA 1/2"	0,1	4,00€
<b>EURO</b>			
13931	CONECTOR MACHO - ROSCA MACHO 1/4"	0,05	2,50€
14075	CONECTOR MACHO - ROSCA HEMBRA 3/8"	0,1	2,00€
13934	CONECTOR MACHO - ROSCA HEMBRA 1/4"	0,05	2,50€
13938	CONECTOR HEMBRA - ROSCA HEMBRA 1/4"	0,1	3,50€
13939	CONECTOR HEMBRA - ROSCA MACHO 1/4"	0,1	4,00€
14077	CONECTOR HEMBRA - ROSCA HEMBRA 3/8"	0,1	4,50€
14190	CONECTOR MACHO - ROSCA HEMBRA 1/2"	0,1	2,00€
14192	CONECTOR HEMBRA - ROSCA HEMBRA 1/2"	0,1	4,00€

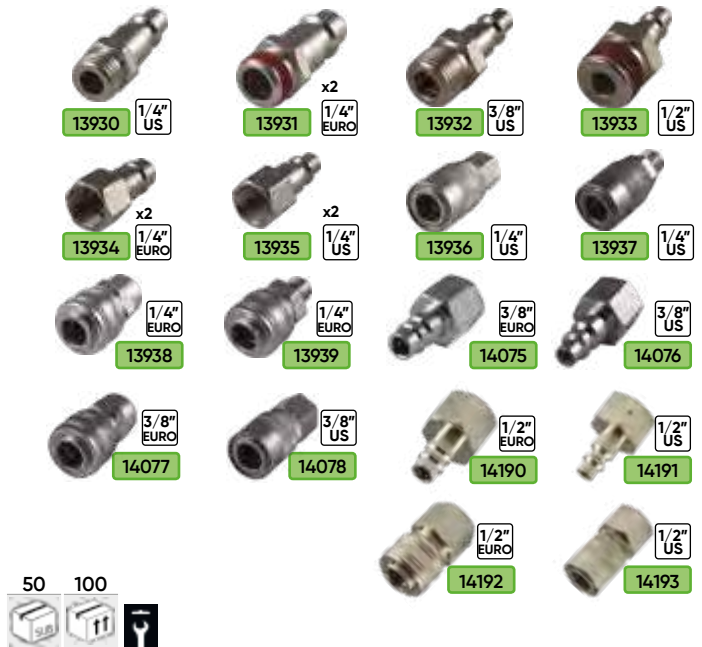

## ENGANCHE NEUMÁTICO RÁPIDO

**52735** 0,07 25 200 **M6**  
4,50€

**52736** 0,07 25 200 **M8**  
4,50€

**52737** 0,08 25 200 **M10**  
5,00€



- Contiene conector macho + conector hembra.

## ADAPTADOR ARTICULADO NEUMÁTICO

**12988** 0,15 125 **1/2"**  
12,00€

**13809** 0,10 250 **1/4"**  
18,50€

**13810** 0,10 250 **3/8"**  
20,50€





SETS DE IMPACTO



152

SETS DE VASOS



153

BARRAS DE EXTENSIÓN / ARTICULACIONES DE IMPACTO



154

SETS DE PUNTAS



155

ADAPTADORES DE IMPACTO / VASOS DE IMPACTO DE 3/4" Y 1"



156

VASOS DE IMPACTO



157

VEHÍCULOS PESADOS



158



# ÚTILES Y VASOS DE IMPACTO



## SET DE 3 VASOS Y 3 PUNTAS DE IMPACTO DE 1/2" HEX

**52337** 1,91 5 10 300  
51,00€

1/2" 6 PCS

CONTIENE

x3 80mmL 30, 32, 36mm  
x3 43mmL 14, 17, 19mm



## SET DE 5 VASOS Y 3 PUNTAS XZN DE IMPACTO DE 1/2"

**52547** 2,76 5 200  
76,00€

1/2" 8 PCS

CONTIENE

x4 27, 30, 32, 34, 36mm  
x3 43mmL M14, M16, M18



## SET DE 13 PIEZAS DE IMPACTO CON VASOS DE 1/2" HEX + ADAPTADOR

**52341** 1,72 12 336  
47,50€

1/2" 13 PCS

10, 11, 12, 13, 14, 17, 19, 21, 22, 24mm

DESPIECE DISPONIBLE

REF.	mm		€	REF.	mm		€
14728	10mm	0,10 5 20	3,00€	11195	17mm	0,10 10 50	3,50€
14729	11mm	0,05 5 20	3,50€	11121	19mm	0,10 10 60	3,50€
14730	12mm	0,05 5 20	3,50€	14733	21mm	0,10 5 20	4,00€
14731	13mm	0,10 5 20	3,00€	14734	22mm	0,15 5 20	4,50€
14732	14mm	0,10 5 20	3,50€	11122	24mm	0,15 10 20	4,50€
14735	Adaptador impacto	0,05 5 20	6,50€	12074	Barra de ext. imp. 125mm	0,23 10 60	11,50€
11990	Articu. univ. de imp.	0,15 10 100	14,00€				

## KIT DE 3 VASOS XZN DE 1/2" DE IMPACTO

**52694** 1,31 5 10 600  
38,00€

1/2" 3 PCS

30, 32, 36mm (78mmL)



## SET DE 19 PIEZAS DE IMPACTO DE 1/2" CON 14 VASOS + ADAPTADORES

**52345** 3,55 6 234  
87,50€

**53531** 3,55 4 234  
87,50€

1/2" 19 PCS

52345: DESPIECE DISPONIBLE

REF.	mm		€	REF.	mm		€
14728	10mm	0,10 5 20	3,00€	14733	21mm	0,10 5 20	4,00€
14729	11mm	0,05 5 20	3,50€	14734	22mm	0,15 5 20	4,50€
14730	12mm	0,05 5 20	3,50€	11122	24mm	0,15 10 20	4,50€
14731	13mm	0,10 5 20	3,00€	11123	27mm	0,35 10 50	5,50€
14732	14mm	0,10 5 20	3,50€	12937	Barra de extensión impacto 50mm	0,11 10 100	9,50€
14970	15mm	0,08 5 20	2,50€	14973	Barra de extensión impacto 150mm	- 5 20	11,50€
14971	16mm	0,07 5 20	2,50€	12075	Barra de extensión impacto 250mm	0,45 10 50	15,50€
11195	17mm	0,10 10 50	3,50€	11962	Adaptador de impacto 1/2"H 3/4"M	0,10 100	7,50€
14972	18mm	0,12 5 20	3,50€	11990	Articulación universal de impacto	0,15 10 100	14,00€
11121	19mm	0,10 10 60	3,50€				

## SET DE 15 PIEZAS DE IMPACTO CON 12 VASOS LARGOS DE 1/2" HEX + ADAPTADOR

**52346** 4,55 6 216  
87,00€

1/2" 15 PCS

DESPIECE DISPONIBLE

REF.	mm		€	REF.	mm		€
12071	24mm	0,30 10 50	11,00€	12061	10mm	0,14 10 100	9,50€
12072	27mm	0,35 10 20	12,00€	12062	12mm	0,15 10 100	9,50€
12074	Barra de extensión impacto 125mm	0,23 10 60	11,50€	12063	13mm	0,15 10 50	9,50€
12075	Barra de extensión impacto 250mm	0,45 10 50	15,50€	12064	15mm	0,17 10 100	9,00€
11990	Articulación universal de impacto	0,15 10 100	14,00€	12065	16mm	0,30 10 20	9,00€
				12066	17mm	0,20 10 50	9,00€
				12067	18mm	0,20 10 20	9,50€
				12068	19mm	0,21 10 50	9,50€
				12069	21mm	0,25 10 50	9,50€
				12070	22mm	0,30 10 20	10,50€





## SET DE 12 VASOS DE IMPACTO DE 1/2" HEX PERFIL BAJO

**53060**  
31,00€

0,86 5 25 500  
Kg US fl

10, 11, 12, 13, 14, 15, 16, 17, 18,  
19, 20, 21mm (28,2mmL)



1/2"

12  
PCS



## SET DE 11 VASOS DE IMPACTO DE 1/2"

**53744**  
51,00€

2,30 5 10  
Kg US fl



**52342**  
53,00€

2,41 5 10 360  
Kg US fl



1/2"

11  
PCS

10, 11, 12, 13, 14, 16, 17, 19,  
21, 22, 24mm (78mmL)



### DESPIECE DISPONIBLE

REF.	mm	Kg	US	fl	€
12061	10mm	0,14	10	100	9,50€
14736	11mm	0,15	5	20	5,00€
12062	12mm	0,15	10	100	9,50€
12063	13mm	0,15	10	50	9,50€
14737	14mm	0,15	5	20	5,00€
12065	16mm	0,30	10	20	9,00€
12066	17mm	0,20	10	50	9,00€
12068	19mm	0,21	10	50	9,50€
12069	21mm	0,25	10	50	9,50€

**52342**



REF.	mm	Kg	US	fl	€
12070	22mm	0,30	10	20	10,50€
12071	24mm	0,30	10	50	11,00€

## SET DE 3 VASOS DE IMPACTO LARGO HEX 1/2"

**52969**  
17,00€

0,8 20 1.500  
Kg US fl

17, 19, 21mm  
(78mmL)



1/2"

3  
PCS



### DESPIECE DISPONIBLE

REF.	mm	Kg	US	fl	€
12066	17mm	0,18	10	50	9,00€
12068	19mm	0,21	10	50	9,50€
12069	21mm	0,20	10	50	9,50€

## SET DE 4 VASOS DE IMPACTO PARA LLANTAS DE ALEACION - 1/2"

**53587**  
36,00€

1,05 5 20  
Kg US fl

1/2"

4  
PCS



### DESPIECE DISPONIBLE

REF.	mm	Kg	US	fl	€
14172	15mm - SMART	0,20	10	50	8,50€
14173	17mm - MERCEDES	0,20	10	50	9,50€
14177	22mm - OPEL	0,25	10	50	9,50€
14178	21mm - HYUNDAI/KIA	0,25	10	50	9,50€



## KIT DE 4 VASOS DE IMPACTO DE 1/2" ESPECIAL EXTRACCIÓN RUEDAS

**52338**  
32,50€

1,12 5 20 640  
Kg US fl



1/2"

4  
PCS

17, 19, 21, 22mm (85mmL)



### DESPIECE DISPONIBLE

REF.	mm	Kg	US	fl	€
11314	17mm	0,21	10	100	8,50€
11315	19mm	0,23	10	100	8,50€
11316	21mm	0,26	10	100	8,50€
11628	22mm	0,27	10	50	9,50€



## KIT DE 3 VASOS DE IMPACTO DE 1/2" ESPECIAL EXTRACCIÓN RUEDAS

**51336**  
21,05€

0,82 5 725  
Kg US fl

17, 19, 21mm  
(85mmL)



1/2"

3  
PCS



## KIT DE 10 VASOS DE IMPACTO DE 1/2" ESPECIAL EXTRACCIÓN RUEDAS

53988

90,00€

1,5

5

85mm



1/2"

10  
PCS

### CONTIENE

x7 1/2"	15, 17, 19, 21, 22, 23, 24mm
x1 7/8"	Tesla
x1 17mm	Mercedes
x1 21mm	Hyundai/Kia



## KIT DE 12 VASOS DE IMPACTO DE 1/2" HEX ESPECIAL EXTRACCIÓN RUEDAS

52343

43,00€

1,89

4

360



1/2"

12  
PCS

### CONTIENE

x3 85mmL	17, 19, 21mm
x1 42mmL	27mm
x8 38mmL	10, 11, 13, 14, 17, 19, 22, 24mm



## SET DE 4 VASOS DE IMPACTO PARA TORNILLOS DE SEGURIDAD 1/2"

53197

40,50€

1,17

5

20

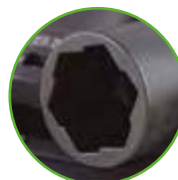

1/2"

4  
PCS

17, 19, 21, 22mm  
(82mmL)

## BARRAS DE EXTENSIÓN DE IMPACTO 1/2"

53077

61,00€

1,58

10

240



CrMo

1/2"

5  
PCS



100, 110, 120,  
135, 150 Nm

### DESPIECE DISPONIBLE

200NM	13680	0,36	175NM	13682	0,32	150NM	13684	0,28	120NM	13686	0,23	100NM	13688	0,22
	15,50€	Kg		15,50€	Kg		15,50€	Kg		15,50€	Kg		15,50€	Kg
190NM	13681	0,35	160NM	13683	0,3	135NM	13685	0,26	110NM	13687	0,22	90NM	13689	0,2
	15,50€	Kg		15,50€	Kg		15,50€	Kg		15,50€	Kg		15,25€	5 50

## BARRAS DE EXTENSIÓN DE IMPACTO 1/2"

12937

9,50€

0,11

10

100

1.500



12074

11,50€

0,23

10

60



12075

15,50€

0,43

10

50



1/2"



50mm



125mm



250mm

## ARTICULACIÓN UNIVERSAL DE IMPACTO 3/4" - 1/2"

11938

39,00€

0,6

60

3/4"



11938

11990

14,00€

0,16

100

1/2"



11990

## SET 3 ARTICULACIONES IMPACTO CON DOBLE POSICIÓN (FIJO / ARTICULADO)

53043

38,50€

0,43

5

50

1.000



1/2"

3/8"

1/4"

3  
PCS





## SET DE 8 VASOS IMPACTO HEX. 1/2" CON DOBLE POSICIÓN (FIJO / ARTICULADO)

53044

2,43 8 1.000

116,00€



1/2"

8  
PCS

13, 14, 15, 16, 17,  
19, 21, 22mm



## SET DE 6 VASOS-PUNTAS XZN DE IMPACTO DE 1/2"

52546

0,81 30 720

31,50€



1/2"

6  
PCS



### CONTIENE

- x3 43mmL M14, M16, M18
- x3 78mmL M14, M16, M18

## VASOS PUNTA XZN INVIOLEABLE 1/2"

52810

0,17 100 M16

9,20€



1/2"

75mm



- Vaso de impacto 75 mm de largo y cuadrado de 1/2" para la extracción del tornillo de drenaje con pistola de impacto en transmisiones de vehículos VAG, Porsche, Ford, etc.

52811

0,17 5 100 M18

9,20€



- Para la extracción del brazo de dirección en vehículos del grupo VAG.



## SET DE 13 PUNTAS DE IMPACTO DE 1/2" HEXAGONAL Y TORX

52344

1,89 4 288

158,00€



1/2"

13  
PCS



### CONTIENE

- x5 45mmL 5, 6, 8, 10, 12mm
- x8 45mmL T30, T40, T45, T50, T55, T60, T70, T80

## SET DE 8 PUNTAS DE IMPACTO HEX DE 1/2"

52339

1,27 5 10 480

58,00€



### DESPIECE DISPONIBLE



REF.	mm				€
14004	5mm	0,1	10	240	9,50€
14005	6mm	0,1	10	60	10,50€
14006	7mm	0,1	10	240	9,50€
14007	8mm	0,2	10	240	9,50€
14008	10mm	0,1	10	240	9,50€
14009	12mm	0,1	10	240	9,50€
14010	14mm	0,1	10	60	11,00€
14011	17mm	0,2	10	60	11,00€



1/2"

8  
PCS

5, 6, 7, 8, 10, 12, 14,  
17mm (78mmL)

## SET DE 8 PUNTAS DE IMPACTO TORX DE 1/2"

52340

1,16 5 10 300

58,00€



### DESPIECE DISPONIBLE



REF.	mm				€
12938	T25	0,08	10	50	10,00€
12939	T30	0,09	10	50	10,00€
12940	T40	0,09	10	50	10,00€
12941	T45	0,09	10	50	10,00€
12942	T50	0,09	10	60	10,00€
12943	T55	0,1	10	50	10,00€
12944	T60	0,12	10	50	10,00€
12945	T70	0,14	10	20	10,50€



1/2"

8  
PCS

T25, T30, T40, T45, T50,  
T55, T60, T70 (78mmL)

## SET DE 6 ADAPTADORES DE IMPACTO

53743

34,00€

0,80 5 20  
Kg Uds Tl

6  
PCS



M	F
3/4"	1/2"
1/2"	3/4"
3/8"	1/4"
1/4"	3/8"
1/2"	3/8"
3/8"	1/2"



### DESPIECE DISPONIBLE

REF.	mm				€
14749	1/4" F - 3/8" M	-	20	100	2,00€
14750	3/8" M - 1/4" F	-	20	100	2,00€
14751	3/8" M - 1/2" F	-	20	100	4,00€
14752	1/2" F - 3/8" M	-	10	100	4,00€

## JUEGO DE 2 ADAPTADORES DE IMPACTO 1"-1/2"

52545

138,00€

1,97 4  
Kg Tl

1" 1/2" F - 1" M  
1" F - 1" 1/2" M



## SET DE 8 VASOS DE IMPACTO LARGOS HEX. 3/4"

53470

146,50€

7,5 1 85  
Kg Uds Tl



3/4" 8  
PCS

24, 27, 29, 30, 32, 34, 36, 38mm (90mmL)



## SET DE 16 PUNTAS DE IMPACTO 3/4"

51028

158,00€

6,26 3 380  
Kg Uds Tl

3/4" 16  
PCS

### CONTIENE

	3/4"	x4	E18, E20, E22, E24
	3/4"	x5	T60, T70, T80, T90, T100
	3/4"	x4	H17, H19, H22, H24
	1" - 3/4"	x2	
		x1	4mm



### DESPIECE DISPONIBLE

REF.	mm				€
14723	H17	0,35	-	10	18,00€
14724	T60	0,30	-	10	18,50€
14725	T70	0,30	-	10	18,50€
14726	T80	0,30	-	10	17,50€



## SET DE 6 ADAPTADORES DE IMPACTO

52544

78,00€

2,89 4 420  
Kg Uds Tl

6  
PCS

1"

3/4"

1/2"

### CONTIENE

1/2" x2	F x 1" M (50mmL), F x 3/4" M (48mmL)
3/4" x2	F x 1" M (63mmL), F x 1/2" M (85mmL)
1" x2	F x 3/4" M (69mmL), F x 1/2" M (70mmL)



### DESPIECE DISPONIBLE

REF.	mm				€
11962	1/2" H - 3/4" M	0,16	10	100	7,50€
11963	1/2" H - 1" M	0,26	6	54	9,00€
11964	3/4" H - 1/2" M	0,34	6	36	12,50€
11965	3/4" H - 1" M	0,44	6	48	16,00€
11966	1" H - 1/2" M	0,53	6	36	18,00€
11967	1" H - 3/4" M	0,53	4	36	18,00€

## SET DE 8 VASOS DE IMPACTO HEXAGONALES 3/4"

52347

130,50€

6,53 4 200  
Kg Uds Tl



3/4"

8  
PCS

26, 27, 29, 30, 32, 35, 36, 38mm (90mmL)



## SET DE 8 VASOS DE IMPACTO DE 1"

52348

154,00€

6,08 2 252  
Kg Uds Tl



1"

8  
PCS

24, 27, 30, 32, 33, 36, 38, 41mm



### DESPIECE DISPONIBLE

REF.	mm				€
13859	24mm	0,6	6	96	16,00€
13874	27mm	0,6	6	24	17,50€
13875	30mm	0,5	6	18	18,50€
13876	32mm	0,6	6	24	18,50€
13877	33mm	0,6	6	24	18,50€
11153	36mm	0,7	6	18	19,00€
11155	38mm	0,9	6	12	20,00€
11158	41mm	0,95	6	18	23,50€





# VASOS DE IMPACTO



1"

REF.	mm				€
11153	36mm	0,71	6	18	19,00€
11154	37mm	0,73	6	24	19,50€
11155	38mm	0,74	6	12	20,00€
11156	39mm	0,74	6	24	21,50€
11157	40mm	0,78	6	12	24,00€
11158	41mm	0,81	6	18	23,50€
11159	42mm	0,91	6	18	25,00€
11160	43mm	0,94	6	12	24,50€
11161	44mm	0,93	6	18	26,00€
11162	45mm	0,94	4	8	26,50€
11163	46mm	1,00	4	12	27,00€
11164	47mm	1,02	4	8	27,50€
11165	48mm	1,01	4	8	28,00€
11166	50mm	1,18	4	12	28,00€
11167	51mm	1,18	4	8	34,00€
11168	52mm	1,18	1	10	33,50€
11169	53mm	1,27	4	12	35,50€
11170	54mm	1,33	4	12	36,00€
11171	55mm	1,44	2	8	40,00€
11172	56mm	1,47	4	8	43,00€
11173	57mm	1,44	4	8	42,00€
11174	58mm	1,58	4	8	42,00€
11175	59mm	1,58	4	8	43,50€
11176	60mm	1,62	2	4	44,50€
11177	62mm	1,63	2	4	49,00€
11178	63mm	1,75	-	8	47,50€
11179	65mm	1,87	2	8	51,50€
11180	67mm	1,93	2	8	52,50€
11181	68mm	1,93	2	8	58,00€
11182	70mm	2,09	2	4	59,00€
11183	71mm	3,10	-	6	63,50€
11184	73mm	3,27	1	4	77,50€
11185	75mm	3,34	1	6	79,00€
11186	76mm	3,70	1	5	80,50€
11187	78mm	3,47	1	5	87,50€
11188	80mm	3,69	1	4	91,00€
11189	85mm	3,81	1	4	98,50€
11190	89mm	3,80	1	2	122,00€
11191	90mm	4,29	1	4	117,50€
11192	92mm	4,50	1	2	133,50€
11193	95mm	4,89	1	2	147,00€
11194	100mm	4,36	1	4	155,00€
11621	105mm	7,81	-	2	273,00€
11622	110mm	7,75	-	2	341,60€
11623	115mm	8,21	-	3	380,00€

1/2"

REF.	mm				€
14728	10mm	0,10	5	20	3,00€
14729	11mm	0,05	5	20	3,50€
14730	12mm	0,05	5	20	3,50€
14731	13mm	0,10	5	20	3,00€
14732	14mm	0,10	5	20	3,50€
11195	17mm	0,10	10	50	3,50€
11121	19mm	0,10	10	60	3,50€
14733	21mm	0,10	5	20	4,00€
14734	22mm	0,15	5	20	4,50€
11122	24mm	0,14	10	20	4,50€
11123	27mm	0,17	10	50	5,50€
11124	30mm	0,20	10	50	6,50€
11125	32mm	0,22	10	50	7,00€

3/4"

REF.	mm				€
11126	19mm	0,25	6	60	10,00€
11127	21mm	0,29	6	24	11,50€
11128	22mm	0,34	6	24	11,50€
11129	24mm	0,32	6	54	11,50€
11130	25mm	0,33	6	24	12,00€
11131	26mm	0,32	6	36	11,50€
11132	27mm	0,35	6	54	11,00€
11133	28mm	0,40	6	48	11,00€
11134	30mm	0,41	6	54	12,00€
11135	32mm	0,44	6	48	14,00€
11136	33mm	0,47	6	24	14,00€
11137	34mm	0,51	6	24	14,50€
11138	35mm	0,49	6	12	15,00€
11139	36mm	0,52	6	18	15,50€
11140	38mm	0,53	6	24	16,50€
11141	40mm	0,54	6	12	17,00€
11142	41mm	0,61	6	12	17,00€
11143	46mm	0,74	6	18	21,50€
11144	50mm	1,00	6	24	27,00€
11145	51mm	1,10	4	12	29,00€
11146	55mm	1,23	4	12	30,50€
11147	57mm	1,23	4	12	36,00€
11148	60mm	1,40	4	12	38,00€
11149	63mm	1,32	4	12	40,50€
11150	65mm	1,50	-	8	44,00€
11151	67mm	1,49	4	12	50,50€
11152	70mm	1,49	4	12	56,50€

1"

REF.	mm				€
11624	65mm	2,42	1	2	151,00€
11625	85mm	5,11	1	2	242,50€
12984	105mm	4,8	-	2	288,50€

1/2" 78mmL

REF.	mm				€
14738	10mm	-	10	100	5,00€
14739	11mm	-	10	100	5,00€
14740	12mm	-	10	100	5,00€
14741	13mm	-	10	100	5,00€
14742	14mm	-	10	100	5,00€
14743	16mm	-	10	100	5,00€
14744	17mm	-	10	50	5,00€
14745	19mm	-	10	50	5,50€
14746	21mm	-	10	50	6,00€
14747	22mm	-	10	50	6,50€
14748	24mm	-	10	50	7,00€
11613	27mm	0,34	10	20	10,00€
11614	30mm	0,42	10	40	12,00€
11615	32mm	0,38	6	24	12,50€
11616	33mm	0,45	6	12	15,50€
11617	34mm	0,40	6	24	16,50€
11618	35mm	0,46	6	18	16,50€
11619	36mm	0,47	6	36	17,00€

1/2" 78mmL

REF.	mm				€
12061	10mm	0,14	10	100	9,50€
14736	11mm	0,15	5	20	5,00€
12062	12mm	0,15	10	100	9,50€
12063	13mm	0,13	10	50	9,50€
14737	14mm	0,15	5	20	5,00€
12064	15mm	0,17	10	100	9,00€
12065	16mm	0,16	10	20	9,00€
12066	17mm	0,18	10	50	9,00€
12067	18mm	0,23	10	20	9,50€
12068	19mm	0,21	10	50	9,50€
12069	21mm	0,24	10	50	9,50€
12070	22mm	0,28	10	50	10,50€
12071	24mm	0,30	10	50	11,00€
12072	27mm	0,35	10	20	12,00€

LARGOS

3/4" 90mmL

REF.	mm				€
13723	19mm	0,41	6	54	15,00€
13724	21mm	0,48	6	12	15,00€
13725	22mm	0,61	6	18	15,00€
13726	24mm	0,56	6	24	15,50€
13727	26mm	0,51	6	18	14,50€
13728	27mm	0,50	6	18	14,50€
13729	29mm	0,71	6	24	17,50€
13730	30mm	0,68	6	24	17,50€
13731	32mm	0,71	6	24	17,50€
13732	33mm	0,78	5	15	18,50€
13733	34mm	0,81	6	18	19,50€
13734	35mm	0,80	6	18	20,00€
13735	36mm	0,81	6	12	20,50€
13736	38mm	0,83	-	6	20,00€

EXTRALARGOS

1" 90mmL

REF.	mm				€
13745	28mm	0,77	6	24	19,50€
13746	30mm	0,95	6	12	19,50€
13747	32mm	0,90	6	12	19,50€
13748	33mm	0,89	6	12	19,00€



# UTILLAJES VEHÍCULOS PESADOS

## VASO DE BUJE CAMIÓN BPW

**52914** 3,16 1 4  
199,00€



- Extracción bujes eje trasero BPW.



120mm 8 CARAS  
CUADRADO HEXAGONAL 41mm

## VASO DE BUJE CAMIÓN BPW

**52915** 2,94 1 8 1.500  
179,00€



- Extracción bujes eje trasero BPW.



111mm OVAL  
CUADRADO HEXAGONAL 41mm

## VASO DE BUJE CAMIÓN BPW

**52916** 2,57 1 8 1.000  
169,00€



- Extracción bujes eje trasero BPW.



109mm 8 CARAS  
CUADRADO HEXAGONAL 41mm

## VASO EXTRACCIÓN EJES CAMIÓN BPW

**52917** 1,11 1  
118,00€



- Extracción bujes tractoras 6,5-9 TON.



65mm OVAL  
CUADRADO HEXAGONAL 36mm

## VASO TAPACUBOS TRASERO EJE BPW

**52918** 2,05 1 8 1.500  
135,00€



- Extracción bujes eje trasero BPW.



95mm  
CUADRADO 3/4"

## VASO TUERCA RUEDA BPW

**52919** 2,8 1 8 1.500  
165,00€



- Extracción eje trasero BPW.



110mm 8 CARAS  
CUADRADO 3/4"

## VASO EXTRACCIÓN TUERCA COJINETES EJE BPW

**52920** 1,35 1 10 1.000  
132,50€



- Para extraer la tuerca anterior a los cojinetes en ejes BPW 12 TON.



80mm  
CUADRADO 3/4"

## VASO EXTRACCIÓN TUERCA COJINETES EJE TRASERO BPW

**52921** 0,73 1 12  
99,00€



- Para extraer la tuerca anterior a los cojinetes en ejes BPW 6,5-9 TON.



65mm  
CUADRADO 3/4"

## VASO EXTRACCIÓN TUERCA EJES BPW

**52922** 2,24 1 10 1.000  
134,00€



- En ejes BPW 16 TON.



85mm 6 CARAS  
CUADRADO 3/4"

## VASO EXTRACCIÓN TUERCA DE SUSPENSIÓN SCANIA

**52923** 0,45 1 12 1.500  
47,50€



28x37mm  
CUADRADO 3/4"



# UTILLAJES VEHÍCULOS PESADOS

## VASO EXTRACCIÓN EJE SUSPENSIÓN SCANIA

52924 0,65 1 24 1.500

58,00€



34x46mm

CUADRADO 3/4"

## VASO EXTRACCIÓN TUERCA SCANIA

52925 1,95 1 8 1.500

142,50€



- Extracción tuerca ejes delanteros.



80mm

8 CARAS

CUADRADO HEXAGONAL 41mm

## VASO EXTRACCIÓN RUEDA TRASERA SCANIA

52926 2,93 1 8 1.500

159,50€



- Extracción tuerca ejes traseros.



100mm

8 CARAS

CUADRADO 3/4"

## VASO EXTRACCIÓN TUERCA BALLESTA SCANIA

52927 0,78 1 20 1.000

65,00€



34x56mm

CUADRADO 3/4"

## VASO DE BUJE SCANIA

52928 2,01 1 10 1.500

139,00€



- Extracción bujes de eje delantero.



80mm

8 CARAS

CUADRADO 3/4"

## VASO TUERCA RUEDA SCANIA

52929 2,68 1 8 1.500

145,00€



- Extracción tuerca buje tercer eje en camiones de 10 ejes.



95mm

8 CARAS

CUADRADO 3/4"

## ÚTIL INSTALACIÓN RETÉN TRASERO ACEITE DEL CIGÜEÑAL SCANIA

52930 2,86 1 4 1.500

115,00€



SCANIA 310/320

RETÉN 0366303-R

## VASO CAMIÓN SCANIA ROTACIÓN ÁRBOL DE LEVAS

52931 0,23 1 60

45,00€



CUADRADO 1/2"

## VASO PARA VÁLVULA DE INYECCIÓN ELECTROMAGNÉTICA SCANIA

52932 0,47 1 20 1.500

44,00€



Ø 38mm

CUADRADO 1/2"

## VASO 8 ALMENAS SCANIA

52933 3,15 1 5

165,50€



SCANIA 420

8 ALMENAS

CUADRADO 3/4"

Ø Exterior: 11,6cm  
Ø Interior: 10cm

# UTILLAJES VEHÍCULOS PESADOS

## VASO DE BUJE PARA IVECO

**53430** 2,90 1 8  
239,50€

- Se utiliza con llave o vaso de 36mm.



Ø Exterior: 134mm  
Ø Interior: 110,5mm

IVECO  
12 CARAS  
118x134mm



## VASO EJE TRASERO CAMIÓN BENZ/MAN

**52936** 1,58 1 10 1.500  
158,00€

- Útiles en furgones.



80-95mm 6 ALMENAS  
CUADRADO 3/4"



## VASO EXTRACCIÓN TUERCA DIRECCIÓN CAMIÓN BENZ/MAN

**52938** 3,22 1 6 1.500  
157,50€

- Para la extracción de la tuerca del eje de dirección.



100mm 6 ALMENAS  
CUADRADO 3/4"



## VASO CAMIÓN BENZ / MAN PARA TUERCA DIFERENCIAL TRASERO

**52940** 4,34 1 4 1.500  
200,00€



104mm 6 ALMENAS  
CUADRADO 3/4"



## ÚTIL ROTACIÓN VOLANTE DE MOTOR BENZ / MAN 3 ENGRANAJES

**52942** 0,87 1 20  
84,50€

- Para Mercedes Actros y Atego.  
- Para Man de 5,6 y 8 cilindros.



CUADRADO 1/2"



## VASO EXTRACCIÓN TUERCA COJINETES EJE BPW

**52944** 0,94 1 20 1.500  
89,00€



30mm  
CUADRADO HEXAGONAL 19mm



## VASO EXTRACCIÓN TUERCA COJINETES EJE TRASERO BPW

**52945** 2,74 8  
220,50€



39mm  
CUADRADO HEXAGONAL 26mm



## VASO TUERCA PRISIONERA CAMIÓN BENZ/MAN

**52935** 0,97 1 10 1.000  
85,00€



60mm CUADRADO 3/4"



## VASO EXTRACCIÓN BUJE TRASERO CAMIÓN BENZ/MAN

**52937** 3,05 1 6 1.500  
215,00€

- Extracción bujes eje trasero.



95-115mm 6 ALMENAS  
CUADRADO 3/4"



## VASO EXTRACCIÓN VÁLVULA INYECCIÓN MAN / BENZ / SCANIA

**52939** 0,18 1 30 1.500  
28,00€



22-28mm 4 ALMENAS  
CUADRADO 3/4"  
DIESEL



## ÚTIL ROTACIÓN VOLANTE DE MOTOR BENZ / MAN 2 ENGRANAJES

**52941** 0,54 1 20 1.500  
61,00€



CUADRADO 1/2"

- Para Benz de 6, 8 y 10 cilindros.  
- Para Man de 12 cilindros.



## ÚTIL CAMIÓN ROTACIÓN VOLANTE DE MOTOR MAN

**52943** 0,49 1 30 1.500  
69,00€



CUADRADO 1/2"



## VASO TUERCA PRISIONERA CAMIÓN BENZ/MAN

**52934** 1,05 1  
88,00€



56mm CUADRADO 3/4"





PARA CHAPISTA



162

PARA FAROS / CASCOS SOLDADURA



163

SETS PALANCAS



164

JUEGO PARA ABRIR COCHES /  
SUSTITUCIÓN DE LUNAS / MORDAZAS



166

PISTOLAS SILICONA / VENTOSAS / CINTAS  
DE SUJECIÓN



169

CARRO ALMACENAJE / CABALLETES



170

SOPORTES



172

MANTENIMIENTO DEL VEHÍCULO



173

EXPOSITORES



174

COLCHONETAS



175

PLATAFORMAS DE ALUMÍNIO



176



# CARROCERÍA



## SET REPARADOR DE ABOLLADURAS

53224

141,50€

3,9

5

40

32  
PCS

- 1 Pistola de pegamento (220-240V ~, 50Hz, 40W).
- 1 Martillo deslizante para la extracción de abolladuras profundas.
- 1 Levantador de abolladuras para la extracción de abolladuras ligeras en superficies planas.
- 1 Limpiador de pegamento.
- 1 Rascador para la extracción suave de las lengüetas para pegamento.
- 8 Barras de pegamento negro (11 x 200mm).
- 19 Lengüetas para pegamento en varios tamaños y formas.



### DESPIECE DISPONIBLE

REF.	DESCRIPCIÓN				€
13842	Bolsa de 5 discos azules	0,15	10	100	8,50€
13843	Bolsa de 4 discos amarillos	0,1	10	100	7,00€
13844	Bolsa de 10 discos rojos	0,3	10	100	9,00€
13845	Bolsa de 5 barras de pegamento	0,95	10	100	8,00€



13842



13843



13844



13845

## PANTALLA PARA INSPECCIÓN DE ABOLLADURAS

53486

28,00€

0,3

10

40

320

- Permite detectar cualquier abolladura, grande o pequeña, de manera muy fácil y notoria, en cualquier parte de la carrocería con su diseño lineal.



Ø 800mm

## CONJUNTO DE MATRICES

Permiten marcar numérica o alfabéticamente todo tipo de superficies metálicas mediante prensado o golpeo. El acabado redondeado de su extremo evita la aparición de grietas o roturas en la superficie trabajada.

### LETRAS Y NÚMEROS

52422

24,00€

0,82

3

6

540

36  
PCS

3/16"



5mm

A-Z & 0-9

53119

45,00€

1,94

3

6

504

36  
PCS

5/16"



8mm

A-Z & 0-9

### NÚMEROS

52882

14,00€

0,30

10

60

1.500

9  
PCS

1/4"



6mm

0-8

## KIT TAS CHAPISTA

52876

182,00€

3,13

6

84

7  
PCS

RECUBIERTOS DE PLÁSTICO



12959



12955



12956



12957



12958



12960



12961

### DESPIECE DISPONIBLE

REF.	DESCRIPCIÓN				€
12955	Tas cara plana y cara oval	0,29	-	25 99	27,80€
12956	Tas de rail	0,31	-	25 99	27,80€
12957	Tas con cara oval	0,37	5	25 99	27,80€
12958	Tas mango con cuña	0,41	-	25 -	27,80€
12959	Tas en coma	0,3	5	25 99	27,80€
12960	Tas de tacón	0,18	-	25 1.500	27,80€
12961	Tas de coma con mango	0,34	-	25 -	27,80€



## SET MARTILLOS ESPECIAL PARA CHAPA



51131

56,00€

5 5 100  
Kg fl

7  
PCS



11544



11541



11542



11543



11545



11546



11547

### DESPIECE DISPONIBLE

REF.	DESCRIPCIÓN				€
11541	Martillo de boca plana	0,43	5	25	8,00€
11542	Martillo plano Peña	0,38	5	25	7,50€
11543	Martillo plano cónico	0,42	5	25	7,50€
11544	Tas de tacón	0,69	5	25	6,50€
11545	Tas de aleta	0,79	5	25	9,50€
11546	Tas dos cantos romo	0,81	5	25	6,50€
11547	Tas de cuña en 8 o carril	0,81	5	25	6,50€

## KIT DE RESTAURACIÓN DE FAROS

53673

98,00€

2,20 10 80  
Kg fl

- Polímero líquido que al evaporizarse permite restaurar los faros que hayan sido dañados debido a inclemencias climatológicas, proporcionando un brillo y acabado perfectos.

- Incluye:  
Líquido especial de lijado (100ml).  
6 papeles de lija.  
Cinta de pintor.  
Placa de lijar.  
Embudo de plástico.  
Tapón especial para la salida de gas.  
Tapón y tubo de plástico para salida de gas.  
Taza vaporizadora.  
Enchufe toma de corriente.  
Enchufe toma de mechero.



14572

38,00€

**BOTELLA DE LÍQUIDO**  
600ml

Polímero líquido que al evaporizarse permite restaurar los faros que hayan sido dañados debido a inclemencias climatológicas, proporcionando un brillo y acabado perfectos.

0,85 4 24 600  
Kg fl

**BRILLO Y ACABADO PERFECTOS**



ACCESORIOS

### DESPIECE DISPONIBLE

REF.	DESCRIPCIÓN				€	REF.	DESCRIPCIÓN				€	REF.	DESCRIPCIÓN				€
14564	Set de 6 papeles de lija	0,10	10	100	9,20€	14568	Tapón de plástico curvado para salida de gas	0,1	10	200	9,20€	14571	Placa de lijar	0,05	10	100	9,20€
14565	Enchufe toma corriente	0,20	10	50	26,70€	14569	Tapón y tubo de plástico para salida de gas	0,1	10	200	9,20€	14572	Botella de líquido 600ml	0,70	4	24	38,00€
14566	Enchufe toma mechero	0,05	10	100	16,70€	14570	Embudo de plástico	0,01	10	200	4,05€	14573	Cinta de pintor	0,01	10	100	4,05€
14567	Taza vaporizadora	0,15	10	20	37,95€												

### BOLSAS DE 10 PAPELES DE LIJA

GRANO 180

14710

0,25

3,50€

GRANO 280

14711

0,20

3,75€

GRANO 360

14712

0,20

4,00€

GRANO 600

14713

0,15

4,25€

GRANO 800

14714

0,15

4,50€

GRANO 1200

14715

0,10

4,75€

## KIT DE PULIDO DE FAROS

53626

17,00€

0,30 12 624  
Kg fl

- Diseñado para restaurar la claridad de las lentes de los faros que se han vuelto amarillentas, turbias o nebulosas.  
- Mejora el rendimiento de las lentes de los faros.  
- Tres pasos sencillos: lijar, pulir y proteger.  
- Restaura los faros delanteros, las luces traseras, los faros antiniebla o las luces direccionales.  
- Este kit está hecho para restaurar 2 faros.

- Contenido del kit:  
2x P800 Disco para lijar.  
2x P1200 Disco para lijar.  
2x P2000 Disco para lijar.  
1x 85g Pasta Pulidora.  
2x 3.0ml Líquido protector UV.  
1x Cinta adhesiva.  
1x Disco Pulidor de Lana.  
1x Disco Esponja Blanco.  
1x Almohadilla de soporte M10 Rosca.  
2x Adaptador (3/8" & 1/4").



EN EXPOSITOR DE 12 UNIDADES

## CASCO PARA SOLDADURA CON REGULADOR MANUAL

53414

61,00€

0,85 6 40



## CASCO PARA SOLDADURA CON REGULADOR DIGITAL

53415

181,00€

0,95 4 40



REGULADOR DIGITAL DE SENSIBILIDAD, OSCURECIMIENTO Y CADENCIA

## CINTURÓN DE SEGURIDAD PARA AUTOCARES

CINTURÓN DE 2 PUNTOS

50644

11,60€

0,40 40 1.600



CUMPLE CON: E4-16R-0436213

CINTURÓN DE 2 PUNTOS ENROLLABLE

50717

21,00€

0,75 10 20 500



CUMPLE CON: E8-16R-0812201

CINTURÓN DE 3 PUNTOS ENROLLABLE

51266

27,60€

1,13 20 320



CUMPLE CON: E4-16R-0436275

## ESTUCHE DE 4 PALANCAS EXTRALARGAS

52977

120,00€

8,61 1 48

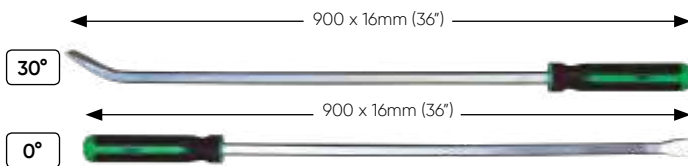

## SET 27 PALANCAS DE NYLON

52788

39,00€

1,18 10 140



- Con diferentes curvaturas y terminaciones, facilitando el trabajo en lugares de difícil acceso, tanto en interiores como en exteriores de los vehículos.



## SET DE 5 PALANCAS DE NYLON

50901

16,00€

0,04 5 20 240



27 PCS

- Universal  
- Especial zonas estrechas  
- Con tirador  
- Uso práctico  
- Tapicerías

- Medidas:  
6 x 160mm  
63 x 175mm  
30 x 200mm  
20 x 180mm  
20 x 215mm





## SET DE 4 PALANCAS DE NYLON TIPO CUCHILLA

51832

18,00€

0,55 6 24 192

Kg S.B. Tl. Tl.



19x273, 22x273, 25x273, 38x273mm



## SET DE 2 PALANCAS EXTRACCIÓN GRAPAS

52851

8,10€

0,24 6 60 800

Kg S.B. Tl. Tl.

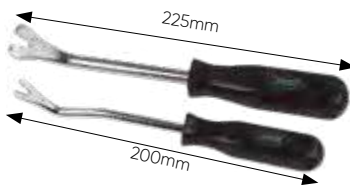

## SET DE 2 PALANCAS DE METAL

52026

25,55€

2,04 5 10 210

Kg S.B. Tl. Tl.

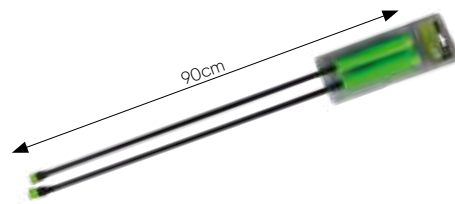

## SET DE 5 PALANCAS DE METAL

50903

23,80€

1,95 4 8 200

Kg S.B. Tl. Tl.



60, 43, 38, 28, 18cm

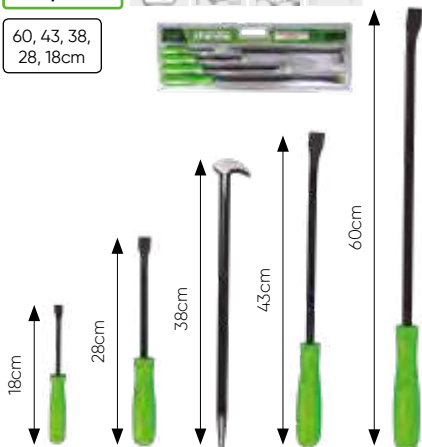

## SET DE 6 PALANCAS

53110

22,00€

1,42 6 12 144

Kg S.B. Tl. Tl.



6 PCS

5"x8.5 / 5"x10.3  
5"x4.5 / 15"x8.5  
15"x10.3 / 15"x4.5mm



## PALANCA EUROPEA CON GANCHO

51360

6,00€

51361

9,80€

0,75  
5  
20

18" x 5/8

1,46  
5  
10  
500

24" x 3/4

FABRICADAS EN ACERO

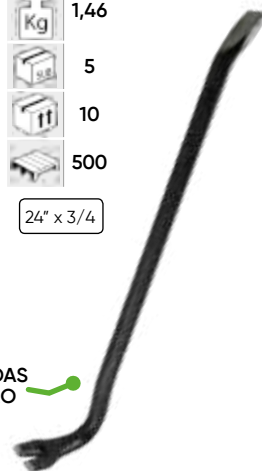

## JUEGO DE ÚTILES PARA ABRIR COCHES

53230

19,00€

0,65 24 360

Kg S.B. Tl. Tl.



UNIVERSAL

8 PCS

- Juego de útiles especial para abrir vehículos sin llave.
- Compuesto de cuñas plásticas, palancas y ganchos curvos.
- Contiene llave universal para tapas de depósito de combustible.
- Para uso en talleres y asistencias.

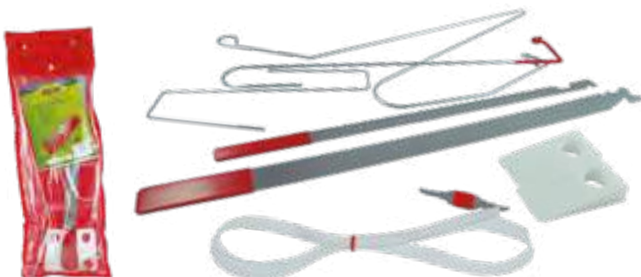

## SET DE 4 ALMOHADILLAS HINCHABLES

52077

29,50€

0,35 5 40 240

Kg S.B. Tl. Tl.

40-50mm

- Introduciéndolas entre el cristal y el marco de la puerta, permiten abrir el vehículo fácilmente y sin dañarlo.
- Presión máxima soportada: 100kg.

- Contiene: Almohadilla de 16x16cm, Almohadilla de 32x12cm, Almohadilla de 19x6cm, Almohadilla de 18x4,5cm, Bomba de mano



PARA REF. 53232

## CABLE PARA EXTRACCIÓN DE LUNAS

13813

6,00€

0,1 10 60

Kg S.B. Tl. Tl.



## ÚTILES DE EXTRACCIÓN DE LUNAS

13814

10,00€

0,2 10 60 840

Kg S.B. Tl. Tl.



## HERRAMIENTAS PARA SUSTITUCIÓN DE LUNAS

53232

39,00€

1,15 10 160

Kg S.B. Tl. Tl.



- Contiene: 1x útil extractor de molduras, 1x palanca para extraer la goma, 1x gancho extractor, 1x 1.8m de alambre de corte, 2x mangos para el alambre de corte, 1x pasa-cables.

# MORDAZAS

**53675**

43,00€

0,75

Kg

RECTA

**53676**

38,00€

0,85

Kg

CURVA



53675

**53677**

47,50€

0,90

Kg

PLETINA ARTICULADA

**53678**

44,50€

0,90

Kg

CURVA LARGA



53677



53678



53678

REF	←	→	10"
53675	250mm	70mm	
53676	250mm	90mm	
53677	250mm	80mm	
53678	300mm	105mm	



EN EXPOSITOR DE 10 UNIDADES



## MORDAZA BLOQUEO

**52505**

18,00€

0,27

5

40

2.160

Kg

us

fl

us

Presentación en caja



CrMo

0-40mm



## MORDAZA BLOQUEO CON PLETINA

**52506**

16,00€

0,29

6

48

2.160

Kg

us

fl

us

Presentación en caja



CrV

0-50mm



## MORDAZA SOLDADURA CON PLETINA

**52512**

44,50€

1,32

20

280

Kg

fl

us

Presentación en caja



CrMo

0-210mm



## MORDAZA DE SOLDADURA

**52511**

40,50€

1,32

20

280

Kg

fl

us

- Presentación en caja



CrMo

0-225mm



## MORDAZA BOCA PLANA

**52507**

27,00€

0,77

30

420

Kg

fl

us

- Presentación en caja



CrMo

0-80mm



## MORDAZA DOBLE PATA

**52504**

25,00€

1,14

30

480

Kg

fl

us

- Presentación en caja



CrMo

0-60mm



## MORDAZA DE SOLDADURA CON PLETINA

**52503**

29,50€

0,85

10

30

540

Kg

us

fl

us

- Presentación en caja



CrMo

0-105mm



## MORDAZA DE SOLDADURA

**52510**

28,50€

0,47

10

50

1.500

Kg

us

fl

us

- Presentación en caja



CrMo

0-150mm



## MORDAZA DE SOLDADURA

**52502**

28,00€

0,84

10

30

540

Kg

us

fl

us

- Presentación en caja



CrMo

0-110mm





## JUEGO DE 6 ALICATES MORDAZA

52385

219,50€

3,72 6 120



Tipo W 195mm



Tipo T 215mm



Tipo L 225mm



Tipo J 210mm



Tipo LL 195mm



Tipo JJ 195mm

TIPO W 195mm

14103 28,00€

TIPO T 215mm

14104 28,00€

TIPO L 225mm

14105 28,00€

TIPO J 210mm

14106 28,00€

TIPO LL 195mm

14107 28,00€

TIPO JJ 195mm

14108 28,00€

## KIT DE 3 ALICATES DE MORDAZA EXTRALARGOS

52982

49,00€

1,6 4 8 400



37cm: punta recta  
36cm: ángulo de 45°  
34cm: ángulo de 90°

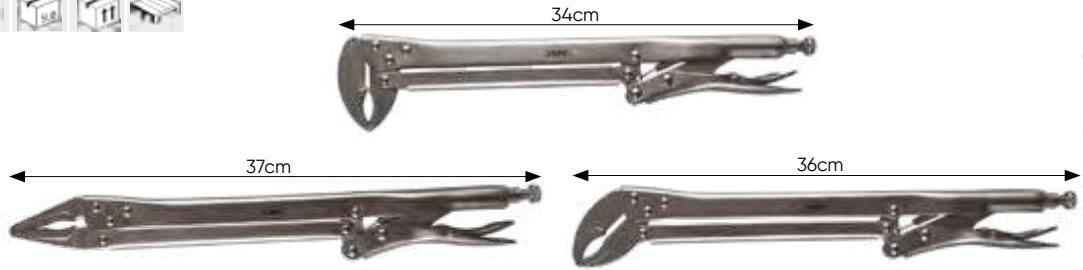

## ALICATE MORDAZA PRESIÓN

50577

12,00€

0,47 5 40 1.000



CrV 280mm

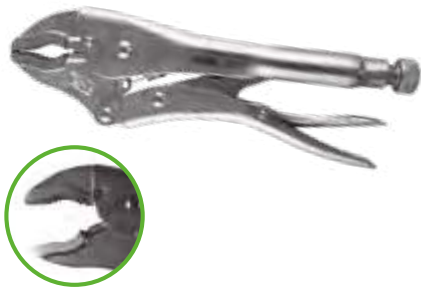

## ALICATE PICO DE LORO CURVADO

52386

22,00€

0,44 10 50 1.500

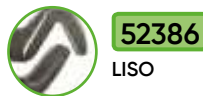

52386

LISO



52387

DENTADO

52387

22,80€

0,44 10 50 1.000



CrMo

215mm



- Agarre a 6 medidas distintas de tuerca / tornillo hexagonal

## MORDAZA ESPECIAL SOLDADURA

52390

31,00€

0,5 5 40 460



250mm CrMo



## ALICATE ESPECIAL EMBRAGUE

52388

24,50€

0,82 5 20 320



305mm CrMo



ACABADO EN ÁNGULO

### MORDAZA PINZA

52477

2,60 10 1.500

61,00€



0-60mm



### MORDAZA 90°

52478

2,75

49,00€

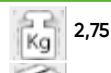

10

1.500

0-20mm



### MINI MORDAZA PLANA 90°

52479

1,18 30

40,80€



0-20mm



### MORDAZA ARGOLLA

52474

3,49 5 1.500

57,50€



0-20mm



### MORDAZA PLANA

52475

3,60 10 1.500

54,50€



0-25mm



### MORDAZA CUADRADA

52476

3,04 6 1.500

49,80€



0-25mm



### MINI MORDAZA CUADRADA 90°

52480

2 10

43,80€



0-25mm



### MORDAZA CUADRADA

52481

1,91 9 1.500

46,00€



0-20mm



Ancho punta 4x1,5mm

### MORDAZA PLANA 45°

52482

2,13 12 1.500

43,80€



0-10mm



### MORDAZA PLANA MINI 5T

52483

2,02 12 1.500

40,80€



0-10mm



### MORDAZA PINZA

52487

2,27 9 1.000

55,00€



0-20mm



### UNIÓN CADENAS

52484

1,19 11 1.500

56,50€



0-110mm



### UNIÓN GANCHOS

52485

1,17 11 1.000

46,50€



0-90mm



### UNIÓN CADENA GANCHO

52486

1,21 11 1.500

51,50€



0-110mm



MORDAZAS



## PISTOLA DE SILICONA PROFESIONAL

52533

0,75 12 24 120

10,00€



9"

300ml



## PISTOLA DE SILICONA NEUMÁTICA

53567

1 10

40,00€



- Presión de trabajo: 2,5-5 BAR.  
- Entrada de aire: 1/4".  
- Capacidad del cartucho: 310ml.



310ml

## SET DE 2 MINI VENTOSAS

52295

0,15 10 100 1.200

6,50€



5KG

Ø 60mm



## VENTOSA EXTRACCIÓN CON MANGO

52589

0,28 10 40 640

12,50€



8KG

Ø 70mm

VENTOSAS

## VENTOSAS

UNITARIA

52262

0,31 12 48 320

7,50€



40KG

Ø 115mm



DOBLE

52263

0,59 6 24 288

13,50€



70KG

Ø 115mm



TRIPLE

52264

0,92 6 10 100

23,00€



100KG

Ø 115mm



CUÁDRUPLE

52265

1,24 10 100

30,50€



120KG

Ø 115mm



## VENTOSA DOBLE ARTICULADA

52765

0,87 5 20 120

21,50€



100KG

Ø 115mm

- Destinada a operaciones de mantenimiento, instalación y desinstalación de partes del vehículo, tanto de chapa como de cristal.  
- De fácil manejo y adaptable a las posibles curvaturas de la superficie.



## CONJUNTO DE VENTOSAS Y CORREA CON TRINQUETE

52998

2,03 8 1.500

55,15€



80KG

Ø 120mm



5m x 25mm

## CINTA DE SUJECIÓN CON TENSOR

52321

0,4 5 20 1.200

5m x 25mm

8,80€



52327

0,46 5 20 1.000

8m x 25mm

12,00€



## CARRO PORTA PIEZAS - PARABRISAS Y CAPÓ

53983

19,40 1 35

214,50€



- Disponible para parabrisas, chapas metales, capós, puertas,...etc.

150  
KG

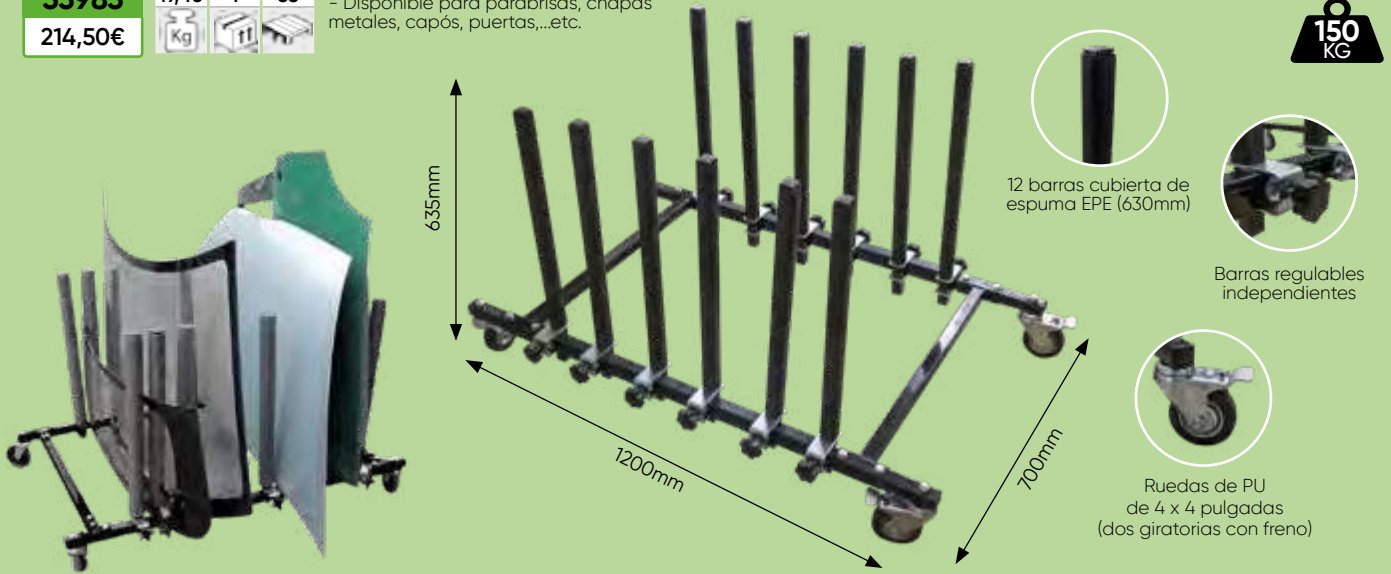

## CARRO PARA ALMACENAJE DE PIEZAS

53125

51 1 12

408,00€



1.800mm

895mm

585mm

200  
KG





# CABALLETE UNIVERSAL TELESCÓPICO

53124

21,10 1 11

286,50€



100 KG



MEDIDAS ALTO

↑ 1.320mm  
↓ 840mm

MEDIDAS LARGO

↑ 1.380mm  
↓ 225mm



## CABALLETE PARA LUNAS DE COCHE

53080

7,87 1 45

99,00€



70 KG



CABALLETE DE MONTAJE  
CON VENTOSA DE GOMA  
SUAVE

MEDIDAS PLEGADO

1.130mm 990mm

## CARRO TRANSPORTADOR ESPECIAL PLANCHA

50923

32,9 1 15

390,00€



480mm 1.300mm 800mm

- Separación de 0 a 110cm.

340 KG



RUEDA PARA REF. 50923

12022 33,70€

CE

## CABALLETE PLEGABLE

52749

6,25 1 29

79,00€



80mm 58mm

220 KG



ESPUMA DE RECAMBIO  
PARA REF. 52749

11959

0,08 100

10,50€



## CABALLETE EN "X"

53079

6,77 1 44

89,00€



100 KG

MEDIDAS DESPLEGADO

660mm 600mm 870mm

MEDIDAS PLEGADO

1140mm 600mm 300mm

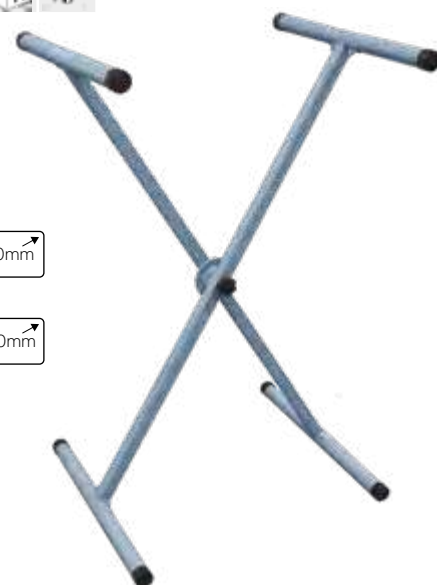

## SOPORTE PARACHOQUES

**53736**

8,10 1 42

97,50€



- Ideal para la sujeción de parachoques, para pintarlos y repararlos con mayor comodidad.

- Anchura ajustable: 75 Cm -160cm  
- Altura máxima: 148cm



ANCHURA AJUSTABLE PERMITE QUE EL SOPORTE SEA ADECUADO PARA SOSTENER VARIOS TIPOS Y ESTILOS DE PARACHOQUES

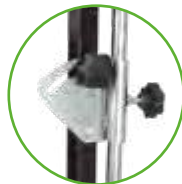

ACERO

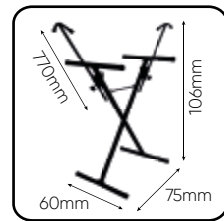

**53685**

14,50 1 14

310,00€

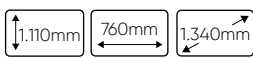

- Sostiene cualquier parachoques sin tocar la superficie pintada.

- Facilita y agiliza las reparaciones y pinturas.

- Giro en 90 grados permite acceder fácilmente a todas la superficie.

- Cinco posiciones distintas de bloqueo.

- Cuatro ruedas de calidad industrial, con bloqueo total para la estabilidad.



AJUSTE DE LOS BRAZOS DE APOYO DE 134 - 198cm

ACERO CON RECUBRIMIENTO DE POLVO

4 RUEDAS DE 4 PULGADAS (DOS GIRATORIAS CON FRENO)

## SOPORTE PARA PINTURA AJUSTABLE

**53134**

14,7 1 36

116,50€



150 KG

- 6 ganchos para sujetar piezas para pintar o secar.

- Marco ajustable que se extiende de 127cm a 203cm.

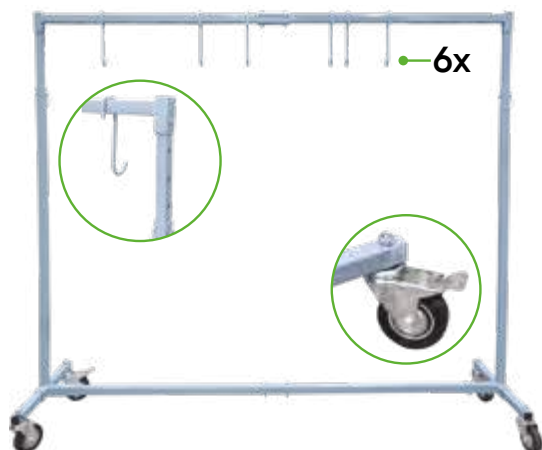

## SOPORTE BASCULANTE PARA PINTURA

**53126**

243,00€

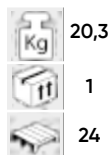

50 KG

- Ideal para puertas, capós, parachoques, aletas, spoilers etc.

- 6 brazos de sujeción:  
4 con gancho fijo  
2 con agujero





# SOPORTE DE REPARACIÓN DE BICICLETAS

53919

85,00€



PARA TODO TIPO DE BICICLETA  
CIUDAD / CARRETERA / BICICLETA DE MONTAÑA

ABRAZADERA  
AJUSTABLE DE  
LIBERACIÓN  
RÁPIDA DE 360°

- Material: Acero Q195, ABS, nylon
- Dimensiones montado: 190x104cm
- Altura ajustable: 107-188cm
- Longitud del tubo transversal giratorio: 37 cm
- Diámetro del tubo transversal giratorio: 35mm
- Diámetro del tubo telescópico: 35mm
- Diámetro del tubo principal: 38mm
- Diámetro del tubo de las patas: 25mm
- Peso máximo de carga: 30 kg



BARRA AJUSTABLE DE  
FIJACIÓN: 50-90CM



Hecha de material  
ABS reforzado y nylon  
para girar la bicicleta  
a cualquier ángulo y  
no dañar la pintura.



CON BANDEJA DE  
HERRAMIENTAS DE PP  
MULTIFUNCIONAL  
25x13cm



4 PATAS  
CON DISEÑO  
ANTIDESLIZANTE

## PORTABOBINA DE PAPEL PARA PARED Y SOBREMESA

53922

23,50€



PAPEL NO  
INCLUIDO

- Material: acero inoxidable
- Rollo: Ancho máx. de 38 cm.

- Sierra de plástico ABS gris.
- Montaje con tornillo y tuercas de acero inoxidable.



## PORTABOBINA DE PAPEL

53921

35,00€



PAPEL NO  
INCLUIDO

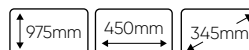

- Material: Acero inoxidable.
- Rollo: Max. ancho 38 cm.
- Sierra de plástico ABS.

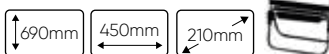
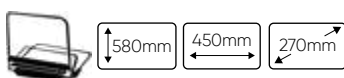

## ROLLO DE FUNDAS DE PROTECCIÓN

MODELO CUIDAMOS  
/ SIN FALDÓN

51978

79,00€



25mc

250 u.

MODELO DIBUJO ANÓNIMO  
/ SIN FALDÓN

52244

79,00€



25mc

250 u.



AMPLIA COBERTURA  
DEL ASIENTO

51978

52244

25 MICRAS  
DE GROSOR

## SET DE EXPOSITOR + MATERIAL DE CUIDADO DEL VEHÍCULO

INCLUYE REF.: 52065,  
52244, 52057, 52058

**50403**

8,9 1 70

99,00€



INCLUYE REF.: 51985, 51978,  
52057, 52058, 50409

**50400**

17 1 35

158,00€



INCLUYE REF.: 51985, 52244,  
52057, 52058, 50409

**50410**

12,44 1 35

158,00€



## EXPOSITOR PARED DE BOBINA CUBREASIENTO, ROLLO VOLANTE Y POSAPIES

**53705**

5,02 1 40

105,50€



**51985**

5,02 1 40

109,00€

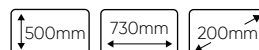

- Soporte funda posapiés.
- Soporte funda asiento.
- Soporte mango film cubrevolante.

## EXPOSITOR PARED DE BOBINA CUBREASIENTOS

**52065**

2,19 1 70

44,50€



## ROLLO DE FILM CUBREVOLANTE

FILM

**52057**

0,62 24 600

6,80€



- Largo: 200m
- Anchura: 12,5cm
- Espesor: 23mc

MANGO

**52058**

0,06 125 2.500

4,50€



## FUNDA POSAPIÉS ANÓNIMA EN PAPEL

**50409**

3,54 250 160

26,00€



250 UDS



## PROTECTOR DE VOLANTE PLÁSTICO

**51824**

1,45 8 72

38,00€



250 UDS



## KIT DE MANTENIMIENTO EN BOLSA INDIVIDUAL

**50916**

0,07 100 400 3.200

0,88€



DISPENSADOR

5in1



20mc



ALFOMBRILLA DE PAPEL



## FUNDA DE ASIENTO COCHE

53226

13,50€

0,3 5 50 900  
Kg UDS PACK

- Universal.  
- De nylon.



## CORTINA PROTECTORA IMANTADA

51622

19,90€

0,45 30 540

Kg UDS PACK

110cm

64cm



4 PUNTOS  
IMANTADOS



DOS CARAS:  
UNA ATERCIOPELADA  
Y UNA PLÁSTICA

## GUANTES CON PALMA REFORZADA DE POLIURETANO

2,00€

0,03 12 144 3.456  
Kg UDS PACK



51640N T. 8

51642N T. 9

51636N T. 10

51638N T. 11



## GUANTES CON PALMA REFORZADA DE NITRILO

2,00€

0,04 12 144 3.456  
Kg UDS PACK



51633 T. 8

51634 T. 9

51632N T. 10

51398N T. 11



## COLCHONETAS

DESPLIEGABLE

53192

49,00€

0,7 2 80  
Kg UDS PACK

- De espuma EVA.  
- Medidas de la colchoneta  
plegada:  
20cm x 40,5cm x 12,5cm.

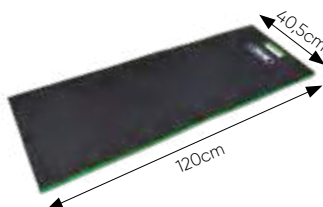

INDIVIDUAL

53191

14,80€

0,15 5 215  
Kg UDS PACK

32cm

48cm



- De espuma EVA.



IVA no incluido



www.jbmcamp.com

175

## PLATAFORMA DE ALUMINIO TELESCÓPICA

**52230**

**295,00€**

16,75 1 14

**150 Kg**

CUMPLE CON: EN 131

- Ancho de la plataforma 300mm.
- Largo de la plataforma cerrada: 1.090mm.
- Largo de la plataforma extendida: 1.750mm.
- Altura ajustable de la plataforma: 520-900mm.
- Ancho del peldaño: 40mm.
- Distancia entre peldaños: 250mm.

- Posiciones: 42 (14 de horizontales x 3 de verticales)  
 Altura 1: 520mm.  
 Altura 2: 700mm.  
 Altura 3: 900mm.

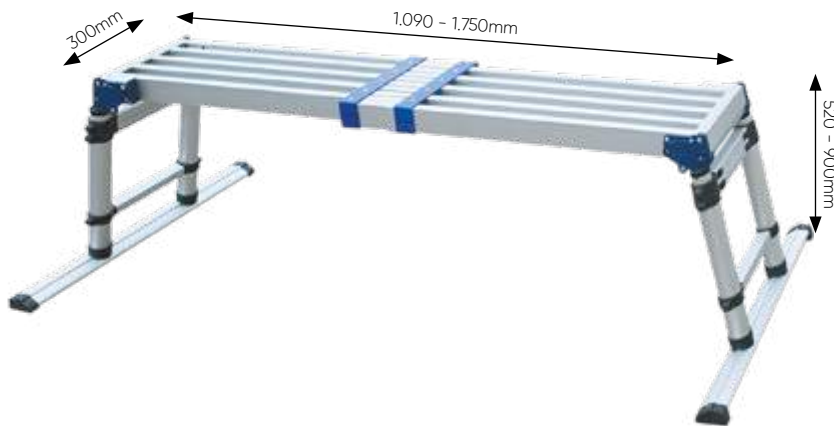

**SUPER LIGERA**



**PLEGABLE**



**MONTAJE FÁCIL**



PIE RECAMBIO PARA PLATAFORMA REF. 52230

**10966** 0,06 1  
**13,50€**

TOPE DE ESCALÓN PARA PLATAFORMA REF. 52230

**10965** 0,01 1  
**6,00€**

PROTECTOR ESQUINA PARA PLATAFORMA REF. 52230

**10964** 0,01 1  
**9,00€**

## PLATAFORMA DE ALUMINIO GRANDE

**50913**

**169,00€**

6,5 1 20

**100 Kg**

800mm 1.400mm 300mm

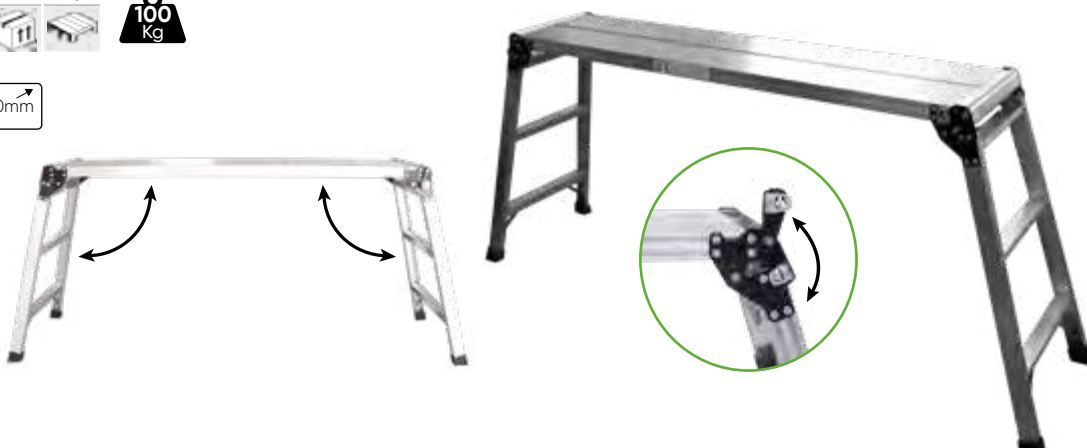

CUMPLE CON: EN 131

## JUEGO DE 2 PLATAFORMAS DE ALUMINIO

**50656**

**250,00€**

10,45 1 12

**100 Kg**

PLATAFORMAS DE ALUMINIO

**15552** 155,00€ 550mm 1.300mm 300mm

**11897** 155,00€ 300mm 1.000mm 300mm



CUMPLE CON: EN 131



REPOSICIONADORES PARA  
PISTONES DE FRENO



178

HERRAMIENTAS PARA REPARACIÓN /  
MANTENIMIENTO



180

PARA LÍQUIDO DE FRENOS



180



# FRENOS



## PISTOLA REPOSICIONADORA DE FRENOS PERFIL BAJO

53683

1,45 5 10 120

106,00€



- Presión de trabajo: 5-8 BAR.
- Presión máxima: 14 BAR.
- Entrada de aire 1/4".
- Soporte de disco magnético.
- Compatible con discos de 2 y 3 pins.



## PISTOLA PARA POSICIONAR FRENOS NEUMÁTICOS

51283

1,33 10 120

66,50€



- Presión de trabajo: 5-8 BAR.
- Presión máxima: 14 BAR.
- Entrada de aire 1/4".
- Soporte de disco magnético.
- Compatible con discos de 2 y 3 pins.



## KIT REPOSICIONADOR PARA PISTONES DE FRENO CON PISTOLA

52636

3,16 5 75

111,00€



16  
PCS

0: GM most 2-1/2" diámetro pistones (Seville/ Eldared 79)  
 2: Citroën XM/Xantia (F/R), HONDA  
 3: Audi (F), Fiat, Alfa romeo (F), Ford Fiesta (F), Isuzu (F), Honda Concesto (F), Jaguar XJ6/ XJ40 (F/R), BMW 318is / 320i / 325T / 518i / 525i-tx / 740i / 850ci / M5 (F), Mercedes BENZ 190/200/300/420/560 serie (F), Mitsubishi Colt (F), Nissan Miera/Stanza/Sunny (F), Rover Austin/Metro200-400 series/Maestra/Montego (F), Toyota Camry (F), VOLVO (F), VW Passat/Golf GTI (F)  
 4: Ford Australia/NZ Telstar, Mazda (R), Saab 9000 (R)/Lumina, Toyota, Fiat 164 2.0 (R), Alfa Romeo Prelude/CRS 16i, Honda Saturn (R)/Grand Prix, GM  
 5: 3/8" Usar el adaptador con una barra de extensión y una carraca para aplicar más fuerza a los pistones  
 6: Nissan Primera, VW Golf IV  
 7: Audi 80/90/V8+100/Coupe E (R), Rover 800 ABS, Subaru L+Z (R), Ford Sierra ABS/Granada/Scorpio ABS (R), Nissan Bluebird 1.8 Turbo/Silvia Turbo/Primera2.0i LS-GS-GSX (R), Peugeot 405 1.9Gi/Gri/Sri/Gtxi/Mi 16/605 2.0 Sri (R), Toyota

Cecilia/Corolla GT/MR2 (R), VW Golf Gti/Jeta Synchrono/Jetta Gti 16v, Passat CL, GL, GT, GT 16v, Corrado 16V scirocca GTX 16v(R), Citroën, Alfa romeo, Fiat, Honda, Jaguar, Renault, Saab, Seat, Lancia.  
 8: GM most 1-7/8" diámetro pistones  
 9: GM most 2-1/8" diámetro pistones  
 A (Z): Renault (R21-Laguna (R))  
 E: Nissan Maximas/Cefiro  
 F (G): Opel (Rear disk)/ Fiat Stilo  
 K: Citroën CS  
 M: Ford, Mini Cooper, Nissan Primera 03  
 N: Saab, Honda, Alfa Romeo 164 2.0 Twin Spark/2.0 Turbo (88-)/3.0 V6, Audi 200 (80-)/Coupe GT SE (82-)/80/90/100/200/Quattro (87-)/90/20V (88-), Ford Mondeo 2.0/Ghia, Lancia Themaite (85-), Volkswagen Golf II GTI (83-87)/Sirocco 16V (84)

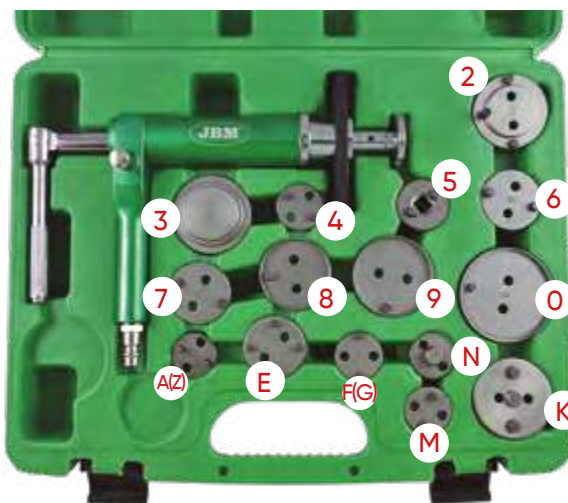

## REPOSICIONADOR PARA PISTONES DE FRENO

52330

5,68 4 60

100,50€



OPEL  
CITROËN

PEUGEOT  
RENAULT

50  
PCS

1pc: Pinza de rotación derecha (con rosca a la derecha)  
 1pc: Pinza de rotación izquierda (con rosca a la izquierda)  
 0: disco: Citroën 1: Disco 11: Disco para Jaguar tipo S  
 12: Disco para BMW mini 5: 13/32" Adaptador (5) con 3/8 Dr. Interior-pt  
 2: Citroën XM, Xantia u.a. 3: Alfa Romeo,Audi, Austin, BMW, Ford, Honda, Jaguar, Mercedes-Benz. Mitsubishi, Nissan Rover, Toyota, VW  
 4: Alfa Romeo 164 2.0,Ford, Mazda, Saab 9000, Subaru  
 6: Nissan Primera, VW-Golf IV  
 7: Audi 80,90,V8 +100, Ford Sierra ABS+ Scorpio ab 85, Honda Prelude, Nissan Silvia 1.8 turbo, Rover 8000, Saab 9000, Subaru L+Z, VW-Golf+ Passat  
 8: GM Motors G: Opel 9: GM Motors K: Citroën C5  
 O: GM Motors K1, K2: Citroen, Renault. M: Ford  
 N: Saab, Honda B: Ford, Lincoln, Subaru  
 Z: Renault C: Mini Austin E: Cefiro, Maxima D: Citroën, Renault  
 F: Peugeot 206 CC/Hai/Gti. Requiere una llave de 16mm con pistones traseros.  
 P: Audi, BMW, Ford, Lancia, Piston, Renault, Rover.  
 J: Alfa Romeo 155 1.8-2.0 164 TD(93) 164 3.0 V6(91), Audi 80,90,A3,A4,A6,A8, Citroen ZX 2 Qi 16V, Fiat Tipo TD 16v, Uno Turbo (85) Crama TD, Ford Sierra ( ABS bak). Granada (85) Crama TD, Ford Sierra (ABS bak). (Australia & NZ) Thunderbird Turbo, Honda CRX, 1.6l-16V (8-90). Accord 1800 (84-85) 2.0i. Prelude 16V (88), Legend V6, Jaguar XJ 4, Oseries, Lancia Dadra 2.0, Ei Tur (93), Delta 1.6 Gti, Nissan, Peugeot, Renault, Seat, Subaru, Volvo V40 8S40.  
 R: Ford Australia& NZ) Teslar, Laser, Mazda 323 Gti, GTXX (86-), 929 (82-), RX7(81-), 626 16V(87-) 626 GT (86-), 929 V6 (88-), Mitsubishi Galant GL Si, Toyota Celica, Corolla GT, MR2  
 S: Audi 100 TQ(91), BMW 740i 8cyl (91), Lancia Delta 19 TD (95), Proton 416. Renault-most models, Renault Laguna 2.0 (94). Laguna 2.2 D (95) Safrane 2.0-2.2 TD V6, Rover 623 Si, Volkswagen Golf Gtu Mk I&IV, Passat VR6, Vento GT (92)  
 H6: BMW  
 H7: BMW  
 Pin 3.0  
 Pin 5.5  
 100g Grasa  
 1/2"Dr+10mm Pentagon bit-56mm Sistema de frenos  
 1/2"Dr+14mm tipo macho-38mm- para frenos pentagono en los frenos traseros del Opel Astra G, Zafira, Smart  
 1/2"Dr+19mm tipo macho-8mm- para frenos Bendix, Citroën, Peugeot, Renault  
 P1: Peugeot 307,308.

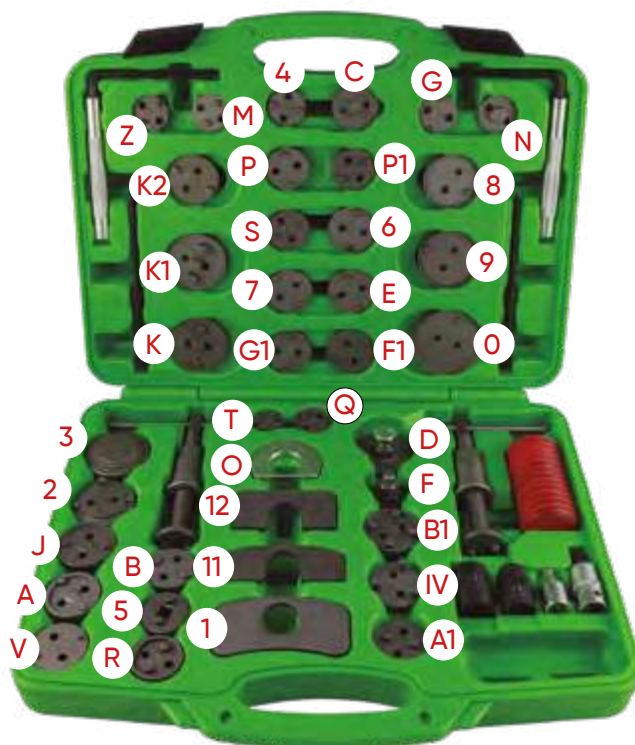



## REPOSICIONADOR PARA PISTONES DE FRENO

51059

94,50€



- Sistema de uso múltiple con 37 piezas para reposicionar los pistones de freno.
- Válido para la gran mayoría de vehículos.
- Contiene:
- 2x llaves hex. de 6 y 7mm.
- 2x tabillas para sistemas de freno de Mercedes y Opel.
- 3x cojines de apoyo para usar en espacios limitados.
- 3x cojines de apoyo para usar en espacios limitados.
- 1x Fuelle con aceite lubricante.

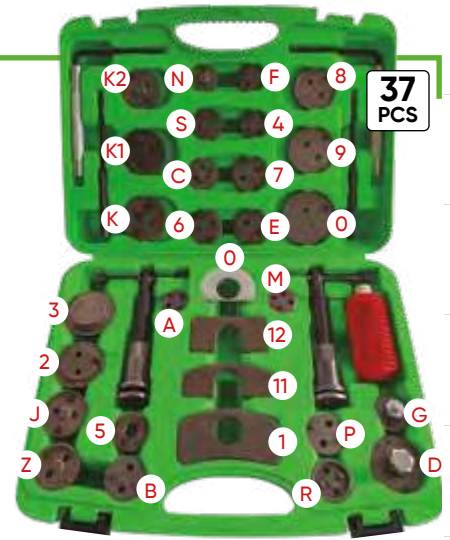

37  
PCS

1pc: Pinza de rotación derecha (con rosca a la derecha) 1pc: Pinza de rotación izquierda (con rosca a la izquierda)  
 O: Disco 1: Disco 11: Disco para Jaguar tipo S 12: Disco para BMW mini 5: Adaptador 3/8 2: Citroen XM, Xantia (F/R)  
 3: Alfa Romeo,Audi,Austin,BMW,Ford,Honda,Jaguar,Mercedes-Benz, Mitsubishi,Nissan,Rover,Toyota,VW.  
 4: Alfa Romeo 164 2.0,Ford,Mazda,Saab 9000,Subaru. 6: Nissan Primera,VW-Golf IV.  
 7: Audi 80,90,V8 +100,Ford Sierra ABS+Scorpio ab 85,Honda Prelude Nissan Silvia 1.8 turbo,Rover 8000,  
 Saab 9000, Subaru L+Z, VW-Golf +Passat.  
 8: GM Motors. 9: GM Motors. O: GM Motors. M: Ford. N: Saab,Honda. Z: Renault. E: Cefiro  
 ,Maxima. G: Opel. K: Citroen C5. K1,K2: Citroen, Renault.  
 A: 1-3/16" disco de dos clavijas para Renault R21, Laguna. B: Ford, Lincoln, Subaru.  
 C: Mini Austin. D: Citroen, Renault. F: Opel (disco trasero)  
 P: Audi, BMW, Ford, Lancia, Proton, Renault, Rover, VW.  
 J: Alfa Romeo 155 1.8-2.0 164 TD(93) 164 3.0 V6(91) Audi,80,90,A3,A4,A6,A8 Citroen ZX 2 Ql 16V,Fiat Tipo TD 16V,Uno Turbo(85) Crama  
 TD, Ford Sierra(ABS bak),Granada (85),(Australia & NZ) Thunderbird Turbo,Honda CRX,1.6l-16V (8-90),Accord 1800(84-85)2.0i,Prelude  
 16V(88),Legend V6,Jaguar XJ40series,Lancia Dedra 2.0 Ei Tur(93),Delta 1.6Gti,Nissan,Peugeot, Renault,Seat,Subaru,Volvo V40& S40.  
 R: Ford (Australia & NZ) Telstar,Laser, Mazda 323 Gti,GTX(86-),929(82-),RX7(81-),626 16V(87-), 626 GT (86-),929 V6(88-),Mitsubishi Galant  
 GL Si, Toyota Celica,Corolla GT,MFR2.  
 S: Audi 100TQi(91), BMW 740i 8cyl.(91), Lancia Delta 19 TD(95), Proton 416, Renault-most models, Renault Laguna 2.0 (94), Laguna 2.2 D(95),Safrane 2.0-2.2 TD V6, Rover 623 Si, Volkswagon Golf  
 Gti Mk 3&4,Passat VR6,Vento GT(92).  
 H6: BMW H7: BMW Pin Ø 3.0 Pin Ø5.5 100g Grasa.

## REPOSICIONADOR PARA PISTONES DE FRENO

53978

44,00€



- Set utilizado para la compresión de los pistones de las pinzas de freno.

O: Placa  
 1: Placa  
 2: General Motors (Ø pistones 21/2")  
 2: Citroën XM, Xantia  
 3: Alfa Romeo, Audi, Austin, BMW, Ford, Honda, Jaguar, Mercedes-Benz, Mitsubishi, Nissan, Rover, Toyota, VW  
 4: Alfa Romeo 164 2.0, Ford, Mazda, Saab 9000, Subaru  
 5: Adaptador cuadrado 3/8"  
 6: Nissan Primera, VW.Golf IV  
 7: Audi 80;90;V8+100, Ford Sierra ABS+Scorpio de 1985, Honda Prelude, Nissan Silvia 1.8 turbo, Rover 8000, Saab 9000, Subaru L+Z, VW Golf + Passat  
 8: General Motors (Ø pistones 17/8")  
 9: General Motors (Ø pistones 21/8")  
 IV: VAG, Renault, Volvo con freno de estacionamiento electrónico  
 R: Renault  
 E: Nissan Maxima, Cefiro  
 F: Opel  
 J: Para Fiat Tipo TD 16V, Uno Turbo(85) Crama TD, Honda CRX, Alfa Romeo 155 1.8-2.0i, 164 TD (93), 164 3.0 V6 (91); Audi 80, 90, & V8's, A3, A4, A6, A8 (pinza trasera); Citroen ZX 2. Ql 16v; Fiat Tipo TD 16V, Uno Turbo (85-), Crama TD; Ford Sierra (ABS bak), Granada (85-); Ford (Australia & NZ) Thunderbird Turbo; Honda CRX, 1.6l-16V (88-90), Accord 1800 (84-85), 2.0i (86-),

Preludi 16V (88-), LegendV6; Jaguar XJ serie 40; Lancia Dedra. 2.0 Ei Tur(93), Delta 1.6 Gti. (92), The. majE 16v(92), Thema. 2000 Turbo. Kappa 2.Q-2.4LS, 2.4TD; Nissan 280 ZX (82-84), 300 ZX Turbo (84-89), Bluebird 16V (89-), Silvia 1.8 Turbo (85-88) 100 NZ 2.0 (93), Primera 2.0 GT (94), 200 SX turbo 16V, Maxima 2.0 GX-3.0 GX (95); Peugeot 306; Peugeot 309 Gtj 16S (91), 405. Srif Q. rj, Gil (87-), 405 M.I 16V; Renault Master Van; Rover 216 Gti 16V, 820 Si 2. O.(93), 825 SD 2.5 (93); Saab 9000 CS 2.0(93), 9000 CSE Turbo(93); Seat Toledo GT. 16V-GT 2.0(93), Lbiza 1.8 Gti 16V(95); Subaru Lserie & Serie 2; Volkswagen Passat 2.0 & 2.2 Litre(84), Golf Rallye (-89), Golf II Gti 16V(89-), Vento GT (92), Transporter T4; Volvo S40 & V40  
 K: Citroën C5  
 K1: Citroën  
 K2: Citroën  
 M: Ford  
 N: Saab, Honda



23  
PCS

## SET REPOSICIONADOR DE FRENOS UNIVERSAL

52906

49,00€



12974



12975

REF.	DESCRIPCIÓN	6	5	€
12974	Recambio 2 pins	0,15	50	21,00€
12975	Recambio 3 pins	0,17	50	23,00€

- Alfa Romeo 164 2.0, Ford, Mazda, Saab 9000, Subaru, Nissan Primera, VW, Audi, Ford Sierra ABS + Scorpio ab 85, Honda Prelude, Nissan Silvia 1.8 turbo, Rover 8000, Saab 9000, Ford, Opel, BMW, Lancia, Proton, Renault, Rover, Peugeot 307, 308 A3- Iveco Daily, Volkswagen Passat 2.0 TDI 09, Renault Laguna.

## MÓDULO REPOSICIONADOR DE FRENOS

14142

101,50€



34  
PCS

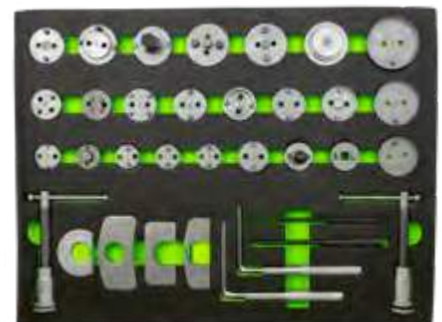

- 24x adaptadores
- 4x placas de retención
- 2x ejes para roscar
- 2x punzones
- 2x llaves hexagonales

## ESTUCHE PARA REPARACIÓN / MANTENIMIENTO DE FRENOS

**52434** 3,05 5 80  
125,50€

- Contiene:  
Llaves de tuerca de freno.  
Alicates de muelle de freno.  
Destornillador de impacto.  
Vasos destornilladores.  
Herramienta de ensamblaje.  
Destornillador con articulación universal.  
Herramienta especial freno.  
Cepillo de limpieza.  
Cepillo de limpieza de latón.  
Herramienta de ensamblaje.  
Alicates de cable de freno.  
Lima para mordaza de freno.



### ALICATES PARA FRENO DE TAMBOR

**52625**  
9,00€

0,32 6 48  
Kg



## COMPROBADOR DE LÍQUIDO DE FRENOS

**51839** 0,05 10 100 2.400  
24,00€

- Funciona a pilas 1xAAA LR03.
- Con 4 niveles de calidad medibles del 0% al 4%.



## SANGRADOR DE LÍQUIDO DE FRENOS

**52191** 9,41 1 12  
198,00€

INCLUYE TAPONES REF. **52328**

- Presión de trabajo: de 0 a 4 kg/cm<sup>2</sup>.
- Aire de 1/2".
- Peso: 5Kg.
- Adaptadores: 11 + 2 universales.
- Aplic.: GM, Chrysler, Nissan.

330mm  
230mm  
230mm



TAPONES PARA SANGRADOR DE FRENOS PARA VEHICULOS GM, CHRYSLER, GM, NISSAN

**52328** 0,75 4 120  
80,00€

- 9 Adaptadores de aceite de los frenos: Universal n°1, n°2, n°3, n°4

## JUEGO DE GALGAS PARA PASTILLAS DE FRENO

**52455** 0,26 10 20 864  
16,00€



COLOR	METRIC	SAE
Green	8-10-12mm	0.3150-0.4720"
Yellow	4-5-6mm	0.1575-0.2382"
Red	2-3mm	0.0787-0.1181"

## SEPARADOR DE PISTÓN Y FRENO

**52315** 0,88 5 430  
14,00€

- Apertura máxima: 80mm.



## ALICATES PARA FRENO DE TAMBOR

**52625** 0,35 6 48  
9,00€

- Para extraer e instalar resortes de retorno en frenos de tambor.

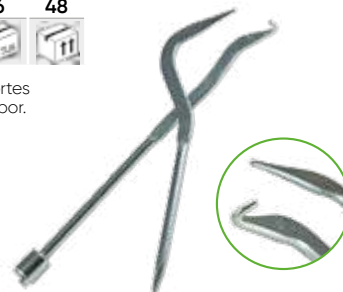

## ALICATE ESPECIAL FRENOS

**52389** 0,32 5 50 600  
29,00€



PESTAÑA DE BLOQUEO

- Para separar el pistón de freno del disco en sistemas de freno en motocicletas y vehículos.

## SANGRADOR DE FRENOS NEUMÁTICO

**52275** 0,79 4 112  
38,00€

- Temperatura de trabajo: 10°C a 50°C.
- Manguera silicona: 1m.
- Pistola de soplado con entrada 1/4".
- Presión aire: 6-12 bar (87 - 174 psi).
- Consumo de aire: 180l/min.





FILTROS 182



ACEITE 186



INYECCIÓN 187



PRESIÓN 190



CALENTADORES / EXTRACTORES 192



ESCAPE 204



DINAMOMÉTRICAS 205



MEDICIÓN 206



MULTIPLICADORES DE FUERZA 207



EMBRAGUE 208



AA/CC 209



SISTEMA DE REFRIGERACIÓN 210



COMPRESORES 213



VARIOS 214



# UTILLAJE



**SERIE363**

## SET DE 5 VASOS 3/8" HEX. EXTRALARGOS

**53545**  
33,50€

0,74 5 20 600  
Kg Ud Ft

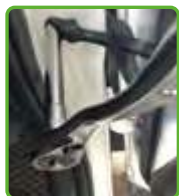

- Permite ajustar el cable de freno de mano en BMW, FORD, OPEL, VAG y VAUXHALL.  
- Útil para bisagras de puertas, para choques y luces traseras entre otros. Sirve también para freno de mano.



3/8" 5 PCS  
BMW, FORD, OPEL, VAG, VAUXHALL Cr-V  
8, 10, 12, 13, 14mm



## JUEGO DE EXTRACTORES PARA FILTROS DE ACEITE/ 19 PIEZAS EN ALUMINIO

**54068**  
211,50€

3,5 2  
Kg Ft

901-1 0592



PIEZAS EN ALUMINIO

### DESPIECE DISPONIBLE

19 PCS

REF.	Nº DE PIEZA	DESCRIPCIÓN	Ø x CANTOS		€
15494	05101	Mazda, Mitsubishi	100,5mm x 15	5 10	12,50€
15495	0595	Nissan, Toyota	94,5mm x 15	5 10	12,50€
15496	0592	Nissan, Subaru	92mm x 15	5 10	11,50€
15497	0579	Toyota, Honda, Mitsubishi, Subaru, Mazda, Lsuzu	79mm x 15	5 10	11,00€
15498	915	Volvo	87mm x 16	5 10	11,50€
15499	901L	Lexus	79,5mm x 14	5 10	11,00€
15500	901T	Toyota	70mm x 14	5 10	10,00€
15501	901-1	Toyota	63-64mm x 14	5 10	10,00€
15502	902	Ford, Mazda	66,5mm x 14	5 10	10,00€
15503	1284	Dodge Sprinter (2007-), Mercedes Benz E320 (2007-), Jeep Cherokee 3.0L V6 Common Rail (2007-)	84mm x 14	5 10	11,00€
15504	903B	Mercedes Benz	74mm x 14	5 10	10,00€
15505	24mm	BMW 5, BMW 7, BMW X5 V8 (N62) (2004-), Saturn (2008), Astra 1.8L ECOTEC, Chrysler 3.6L V6 (2011-), 200, 300, T/C Dodge Jeep	24mm x 14	5 10	4,00€
15506	27mm	Mercedes Benz Clase A	27mm x 6	5 10	4,00€
15507	30mm	Audi A2, Vw Polo, Lupo 1.4L/1.6L	30mm x 6	5 10	4,50€
15508	32,5 mm	Opel Astra G, Corsa B, Zafira, Audi, VW 1-36 mm, Opel Omega, Vectra B, Zafira (98-), BMW M43/60	32,5mm x 6	5 10	4,50€
15509	36mm	Opel Omega, Vectra B, Zafira (98-), BMW M43/60, Mercedes Benz Vito CDI, C, E, VW Lupo 1.2 TDI, MAN	36mm x 6	5 10	5,00€
15510	38mm	Opel Vectra 2.0D	38mm x 6	5 10	5,00€
15511	917	Universal	55-90mm	5 10	8,00€

## JUEGO DE EXTRACTORES PARA FILTROS DE ACEITE

**51332**  
98,00€

4,19 5 60  
Kg Ft

11376 11385



PIEZAS EN ALUMINIO

### DESPIECE DISPONIBLE

23 PCS

REF.	Nº DE PIEZA	DESCRIPCIÓN	Ø x CANTOS		€
11374	901	Toyota, Nissan, Fiat Daihatsu	65mm x 14	0,10 5 20	5,50€
11375	902	Toyota, Daihatsu	67mm x 14	0,08 5 20	6,50€
11376	903	VW, Mercedes, BMW, Opel, Audi	74mm x 14	0,09 5 20	5,50€
11377	903-1	GM/AC, Wix, Ford, Isuzu	75mm x 15	0,09 5 20	5,50€
11378	903-2	VW, Audi, Seat, BMW, Renault	74mm x 8	0,09 5 20	6,50€
11379	903-3	Audi, Rover, Chrysler	74mm x 15	0,11 5 20	6,00€
11380	903-4	Toyota, Lexus	73mm x 14	0,11 5 20	6,50€
11381	903-6	Schlepper, Baumashinen	75mm x 12	0,10 5 20	6,50€
11382	918	Rover, Chrysler, Audi	74mm x 15	0,11 5 20	6,00€
11383	904	Nissan, Ford	79mm x 15	0,10 5 20	6,00€
11384	905	GM, Chrysler	73mm x 15	0,12 5 20	6,00€
11385	905-1	BMW, Mercedes, Opel, Audi, VW	74mm x 14	0,10 5 20	5,50€
11386	906	Baummaschinen, Schlepper	84mm x 18	0,10 5 20	6,00€
11387	907	Mitsubishi, Toyota	89mm x 15	0,13 5 20	6,00€
11388	908	Nissan, Toyota	91mm x 15	0,14 5 20	6,00€
11389	915	Honda Accord, Mitsubishi, Isuzu	90mm x 15	0,16 5 20	6,00€
11390	910	Toyota, Alfa Romeo, Ford	95mm x 15	0,12 5 20	6,00€
11391	911	Fiat, Renault, Citroën	76mm x 12	0,09 5 20	6,50€
11392	911-1	Subaru, Toyota, Honda, Nissan	80mm x 15	0,09 5 20	6,00€
11393	914	Mazda, Toyota	101mm x 15	0,18 5 20	6,00€
11394	909	Isuzu, Nissan	92mm x 15	0,14 5 20	6,00€

REF.	DESCRIPCIÓN				€
14992	Llave de 12 cantos	0,10	-	-	8,50€
10955	Carraca de 1/2"	0,14	-	1 50	11,00€



# VASOS EXTRACCIÓN PARA FILTRO DE ACEITE

**52311** 0,13 6 72 1.728  
19,00€



GRUPO VAG

42mm

**52312** 0,1 10 100 1.728  
9,00€



VW, OPEL, MERCEDES, BMW, AUDI

74mm x 14C

**52313** 0,2 6 72 216  
8,00€



VOLVO 540, 560, 570, 580

86mm x 16C

**52314** 0,28 5 50 600  
24,00€



BMW VOLVO

87mm x 16C

Presentación en caja

**52809** 0,15 10 100 600  
7,80€



TOYOTA

64,5mm x 14C

3/8"

**53441** 0,2 5 20  
9,80€



76mm x 14C

## EXTRACTOR DE FILTROS DE ACEITE FORD, CITROËN, PEUGEOT 2.0, 2.2 HDI, TDCI

**53008** 0,6 5 30 1.500  
15,50€

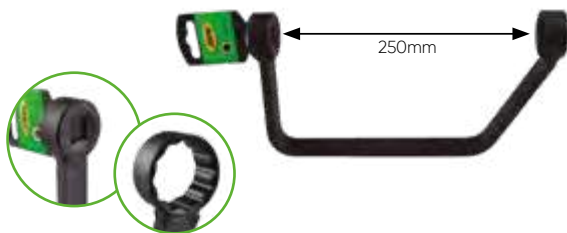

## EXTRACTOR FILTROS CAMIÓN

**52518** 1,4 6 12 480  
88,00€



95-165mm



## SET DE EXTRACTORES DE ACEITE

**52615** 3,05 5 80  
100,00€



- Llave de doble sentido ajustable.  
- Rango de aplicación: 60-80mm.

Audi, BMW, Mercedes, Opel, Renault, Volvo, Kia, Hyundai, Ford, VW, Skoda, Citroën, Mini

1/2" x1 **UNIVERSAL** 63-83mm

3/8" x8



- 27mm: Mercedes-Benz, Smart.  
- 32mm: GM, Opel/Vauxhall, Mercedes-Benz.  
- 36mm: Mercedes Diesel, BMW, Mini, Ford.



- 88,8mm: Hunday, Kia.



- 64,5mm: Toyota (Allion, Auris, Corolla, Prius, Voxy, etc.).  
- 64,5mm: Toyota, Lexus (6 Zyl.).  
- 74,2mm: Audi, BMW, Ford, Toyota, Volkswagen, Porsche, Mercedes-Benz.



- 86,6mm: BMW 3+5+X, Volvo.



9 PCS

## EXTRACTOR FILTRO DE ACEITE CON PATA REDONDA / PLANA

- Puede usarse con llaves de 1/2" o 3/8".

**51352** 0,34 5 40 1.280  
8,50€



57-118mm

**51934** 0,38 10 40 1.200  
10,00€

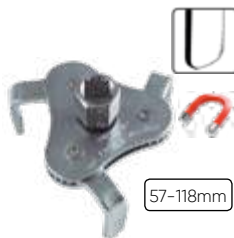

57-118mm

**51353** 0,57 5 40 960  
10,50€



72-136mm

**51923** 0,56 10 40 1.020  
11,00€



72-136mm

- Extrae todos los filtros de aceite de 2-1/4" a 5" de diámetro.

- Extrae todos los filtros de aceite de 2-1/2" a 4" de diámetro.

- Extrae todos los filtros de aceite de 2-1/2" a 4" de diámetro.

- Extrae todos los filtros de aceite de 2-1/2" a 4" de diámetro.

## SET 5 VARILLAS PARA COMPROBACION ACEITE BENZ/AUDI

53206

0,4 5 50 300  
Kg u.s. fl. fl.

33,50€

- Para comprobar el fluido de transmisión de aceite en los motores Audi 100:  
La punta (primera 11 mm) es la lectura del fluido frío a 20 °C.  
La segunda lectura es el mínimo a 80 °C.  
La tercera lectura es a 80 °C máximo.  
- Mantenga el nivel del vehículo al revisar ATF.  
- Varilla medidora del motor para comprobar el nivel de aceite, compatible con una gran selección de motores de 1988 a 2005 en la gama Mercedes.

AUDI  
110mm

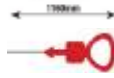

- AUDI 100 motores

MERCEDES-BENZ  
110mm

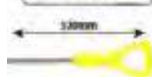

- Año de la fabricación: 1988-1997.  
- Códigos de motor: 103.104.111.119.120.137.604.605.606.611.612.613.628.642.647.648.

110mm



- Código de la transmisión: 716.5.722.7.722.8.

110mm



- Año de la fabricación: 1996-2005.  
- Códigos de motor: 03.104.111.112.113.119.120.137.271.272.604.605.606.611.612.613.628.642.646.647.648.

AUDI  
110mm



- Código de transmisión: 722.6.

5  
PCS

13856

7,80€

VARILLA PARA COMPROBACIÓN DE ACEITE - AUDI

0,04 5 100  
Kg u.s. fl.

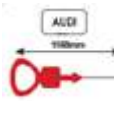

## PINZA EXTRACTORA DE FILTROS DE ACEITE

51354

11,00€

0,43 5 40 680  
Kg u.s. fl. fl.

80-120mm



## LLAVE PARA FILTRO ACEITE GRUPO VAG DSG 1/2" 24MM

53670

29,50€

0,25 10 40  
Kg u.s. fl.



1/2"

- Herramienta especial diseñada para el montaje y desmontaje del filtro de aceite del engranaje DSG.  
- Su tamaño reducido permite alcanzar fácilmente el filtro de aceite del engranaje DSG sin necesidad de quitar la batería.



## EXTRACTOR DE FILTROS DE CINTA

52269

7,00€

0,15 10 50 800  
Kg u.s. fl. fl.

80-120mm

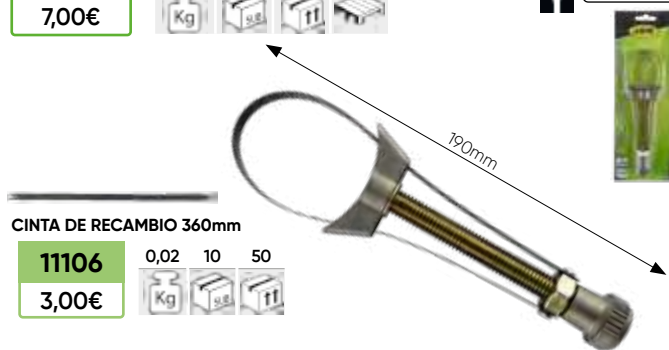

CINTA DE RECAMBIO 360mm

11106

3,00€

0,02 10 50  
Kg u.s. fl.

## EXTRACTOR DE FILTROS AJUSTABLE

52677

17,00€

0,32 10 40 480  
Kg u.s. fl. fl.

Ø 65-105mm

52678

18,00€

0,33 10 40 480  
Kg u.s. fl. fl.

Ø 110-155mm



REF.	CINTA DE RECAMBIO	PARA	u.s.	fl.	fl.	€
11936	383mm	52677	0,03	-	100	4,00€
11937	540mm	52678	0,04	10	100	5,00€

## EXTRACTOR FILTROS DE CADENA

52417

24,00€

0,87 5 25 800  
Kg u.s. fl. fl.

Ø 160mm

300mm



## EXTRACTORES FILTROS DE CORREA

52416

10,50€

0,34 5 50 1.050  
Kg u.s. fl. fl.

Ø 150mm

20mm

540mm





## EXTRACTORES FILTROS DE CADENA

**52607** 0,86 6 24 432  
 49,00€      Ø 60 - 140mm

**52608** 0,99 6 24 576  
 42,50€      Ø 60 - 195mm





- El más largo del mercado.



DOBLE CADENA ARTICULADA







## TAPONES DE CÁRTER PLÁSTICOS

**53741** 0,05  
 12,00€    







FORD/PSA

**13969** 0,01  
 15,50€    



VAG

**53537** 0,05  
 12,80€    



BMW

**53538** 0,10  
 12,80€     **5 PCS**



FORD







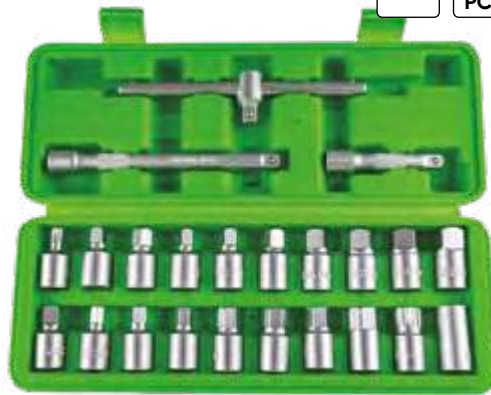



## JUEGO DE VASOS PARA TAPONES CÁRTER

**53735** 1,70 12 504  
 41,00€    



3/8" **23 PCS**

### CONTIENE

	x2	5/16", 3/8"
	x7	7, 8, 10, 11, 12, 13, 14mm
	x1	10mm
	x1	10mm
	x7	8, 9, 10, 12, 13, 14, 17mm
	x1	T45
	x1	M16
	x1	200mm
	x2	75, 150mm



## MÓDULO EVA JUEGO DE VASOS PARA TAPONES CÁRTER

**15084** 2 10  
 46,50€  









**22 PCS**

MÓDULO ACABADO EN FIBRA DE CARBONO

240x135x32mm



### CONTIENE

	x2	5/16", 3/8"		x1	T45
	x7	7, 8, 10, 11, 12, 13, 14mm		x1	M16
	x1	10mm		x1	200mm
	x1	10mm		x1	150mm
	x7	8, 9, 10, 12, 13, 14, 17mm			

## LLAVE PARA TAPÓN DE CÁRTER DE PLÁSTICO (VAG)

**53472** 0,1 10 100  
 12,00€    

OEM: T10549



- Función: Para la extracción de tapones de cárter de plástico.

- Aplicaciones:  
 Audi: A1, A3, A4, A5, A6, A7, Q3, Q5, Q7, TT, TTS.  
 Seat: Alhambra, Leon, Toledo.  
 Skoda: Octavia, Rapid, Superb, Yeti.  
 VW: Beetle, Caddy, CC, Golf, Jetta, Passat, Polo, Scirocco, Sharan, Tiguan, Touran.

## LLAVE TAPÓN CÁRTER



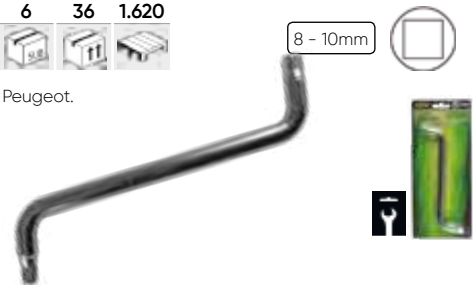

**52617** 0,23 6 36 1.620  
 7,00€    

8 - 10mm

- Para Citroën, Renault, Peugeot.



## SET EXTRACTOR DE TAPONES DE CÁRTER DE PLÁSTICO

**53473** 0,4 10 50 300  
 36,00€    

**5 PCS**



FORD, VAG, PEUGEOT, CITROËN, BMW

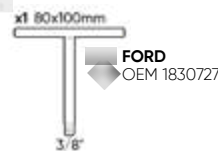

x1 3/8" **PEUGEOT / CITROËN**  
 OEM 9801444780  
 OEM 18711598

x1 10mm 1/4"  
**BMW**  
 OEM 11137605018

x1 1/4" (1.5mm)  
**VAG**  
 OEM 06L 103 801

## KIT DE REPARACIÓN DE TAPONES DE CÁRTER

51337

1,58 10 180

48,00€



- Tapones de SKS3.
- Brocas de 1015.
- Arandelas de cobre.

- Contiene:  
M13x1,5P  
M15x1,5P  
M17x1,5P  
M20x1,5P

- Brocas: 1 x medida
- Tapones: 5 x medida
- Arandela: 10 x medida



### DESPIECE DISPONIBLE

5 tuercas + 5 arandelas\*

REF.	DESCRIPCIÓN					€
51403	M13 x 1.5P	0,13	5	50	100	17,50€
51400	M15 x 1.5P	0,17	5	50	100	17,00€
51401	M17 x 1.5P	0,15	5	50	100	22,00€
51402	M20 x 1.5P	0,1	5	50	100	20,50€

\*x5 Entregado en bolsas de 5 unidades.

Machos

REF.	DESCRIPCIÓN				€
14930	M13 x 1.5P	-	10	100	9,50€
14931	M15 x 1.5P	-	10	100	8,00€
14932	M17 x 1.5P	-	10	100	9,50€
14933	M20 x 1.5P	-	10	100	9,50€

## SET REPARADOR DE ROSCAS DE TAPÓN DE CÁRTER

53235

0,3 10 40

9,50€



M13



53236

0,3 10 40

11,55€



M15



53237

12,50€



0,3  
10  
40

M17

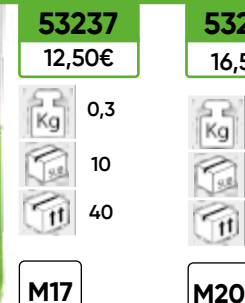

53238

16,50€



0,4  
10  
40

M20



## EXTRACTOR DE INYECTORES DIESEL PARA CITROËN, PEUGEOT

53069

2,44 5 150

98,00€



CITROËN  
PEUGEOT

- 1x Base.
- 3x pilares para la base.
- 2x Husillo extractor - Ø17mm, Ø25mm.
- 1x Tuerca para husillo.
- 2x Vasos para inyectores de 25mm y 29mm.
- 1x Llave Allen de seguridad de 21mm.



## KIT DE EXTRACCIÓN DE INYECTORES

51494

3,63 5 20 125

107,00€



- Con martillo deslizando para motores CDI y motores Mercedes CDI OM 611, 612, 613 etc. Para extraer los inyectores atascados y common-rail sin desmontar la culata.

- La construcción robusta permite una reducción drástica de los inyectores

- más severamente bloqueados.
- Material: acero S45C.
- Longitud total: 350mm

- Contenido:  
Martillo: 1.75 kg,  
Adaptador: M17x1,0  
Adaptador para la boquilla Bosch: M27 x 1,0  
Adaptador tirador w/M12 x 1.75P



## EXTRACTOR DE INYECTORES PARA MERCEDES-BENZ CDI

51499

146,00€



3,61 5 125



- Extractor Injector Set para Mercedes CDI 4335.
- Este conjunto de siete piezas tirador ha sido especialmente diseñado para la eliminación de los inyectores de stubbon.
- Mercedes Benz equipados con motores de vehículos CDI.

## LLAVE ABIERTA DOBLE PARA INYECTORES

52821

27,50€

0,24 6 96



17mm



- Material: Chrome Vanadium.
- Doble estrella abierta acodada.
- Adecuada para zonas de difícil acceso.



## EXTRACTOR UNIVERSAL PARA INTERIORES/EXTERIORES

53250

4,8 2 4 90

71,00€



- Material: acero.
- Extracción externa: de 40 a 80mm.
- Extracción interna: de 50 a 150mm.

- Incluye:  
 Extractor de triple garra exterior.  
 Triple garra int. para extracción de rodamientos.  
 1 extractor profundo.  
 1 conector de tornillo.



## SET DE EXTRACTORES DE INYECTORES

52858

21,20 1 32

298,00€



- Componentes:

3 martillos deslizantes diferentes:  
 1,6 kg, longitud 160 mm.  
 2,7 kg, longitud de 460 mm.  
 5,1 kg, longitud 600 mm.

2 garras de tiro con apertura de horquilla:  
 13,7 x 18 mm, longitud 105 mm.  
 12,7 x 19 mm, longitud 130 mm.

5 vasos ranurados 1/2" y 6 caras, longitud 100 mm, tamaños:  
 25, 27, 28, 29, 30mm.

Extractor de inyector, diseño del manguito, con casquillos:  
 Diámetro exterior 35 mm.  
 Diámetro interior 29 mm.  
 Husillo m17 x 1,0.

Adaptador de tiro con rosca exterior:

M27 x 1,0 (3 piezas) y M25 x 1,0.

Adaptador de tiro con rosca interior:  
 M27 x 1,0 (3 piezas).

Adaptador para el martillo deslizante para extractor interior, exterior y garra.



## EXTRACTOR DE INYECTORES PARA GRUPO VAG

52622

73,50€

VW  
AUDI

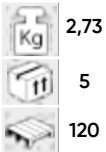

2,73

5

120



## EXTRACTOR PARA INYECTORES MERCEDES

52629

90,50€

MERCEDES



1,22

50

440



M16X1.5

- Material: Cromo molibdeno SD45C.
- Para motores VW, Audi DIESEL.
- Aplicaciones: 1,4 SDI, TDI, 1,9 D, SDI, TDI, TDI (PD), 2,0 TDI (PD) & (PD 4-VALVES), 2,5 TDI / TDI(PD), 2,8 TDI (PD), 2,7, 3,0 TDI (Common Rail), 4,2 TDI (Common Rail).

- Especifico para Mercedes (C/E/S CLASS, VITO) INJ.
- Mercedes / Bosch solución inyector.
- Extractor específico para inyectores Mercedes, completo, con enchufe para el desmontaje de la conexión eléctrica.

## EXTRACTOR DE BOMBA DE INYECCIÓN DIESEL BMW

53501

20,00€

0,55 10 20



- Sostiene las ruedas dentadas durante el montaje de la bomba de inyección.



- BMW: M47 / M47T2 / M47TU / M57 / M57TU.
- SERIES: E46 (318D-320D) (1988 - 2005) and E60, E61 (318TD-320TD-525D-530D-530-535) (2000 - 2006).
- OEM1 13 5 191 | 13 5 192 | 13 5 190 BMW.

## EXTRACTORES DE TUBOS DE INYECCIÓN DIESEL

53009

38,00€

0,5 4 20 560



14, 17, 19mm



3/8"



## EXTRACTOR DE ARANDELAS DE INYECTORES

53522

19,20€

0,09 5 20 300



Ø 4,5 - 15mm

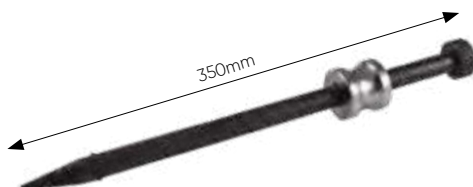

## SET DE 2 LAPEADORES DE VÁLVULAS

52850

6,50€

0,11 6 72



Ø 3,49-2,86mm  
 Ø 1,59-2,06mm

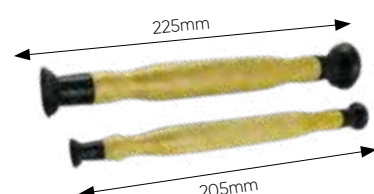

## MEDIDOR Y COMPROBADOR DE SISTEMA DE INYECCIÓN

51493

66,00€

0,96 5 120  
Kg U.S. ft

Adecuado para uso en BOSCH, SIEMENS, DENSO y DELPHI

- El propósito de este instrumento es medir con rapidez y eficacia la cantidad de combustible (diesel o gasolina) que cada inyector vuelve al tanque de depósito, de modo que usted sabrá si algún inyector está dañado.

- Incluye:  
Percha para colgar con 6 botellas de medición graduadas.  
6 tubos de medición (para crack única condición).  
Tubos blancos de descuento.  
Estuche de almacenaje



### BOTE + TAPÓN + MANGUERA

12901

5,20€

0,03 10 60  
Kg U.S. ft

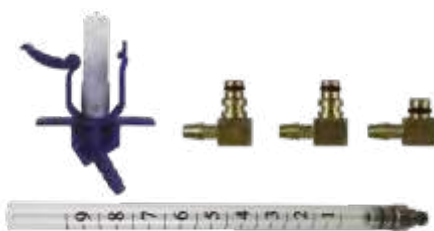

## SET 17 PCS ESCARIADOR INYECTORES

52813

71,00€

2,23 5 180  
Kg U.S. ft

- Para el reacondicionamiento de los inyectores.

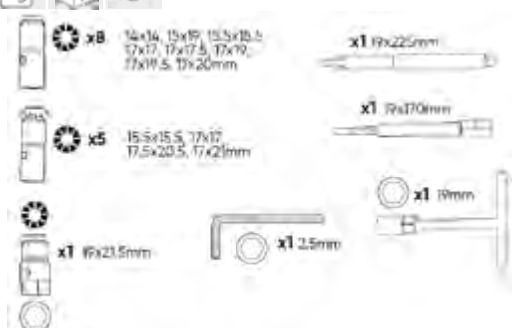

17 PCS

## SET ESCARIADOR INYECTORES

52273

44,00€

1,28 5 220  
Kg U.S. ft

- Juego de 7 escariadores para limpiar los asientos de los inyectores, cuando en los motores diesel se reacondicionan o sustituyen los inyectores.

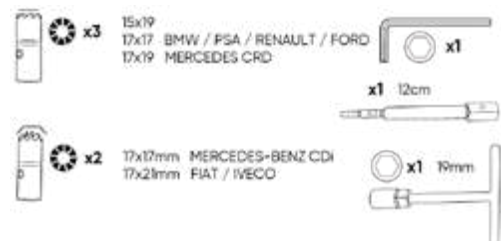

8 PCS

## SET DE VASOS PARA BOMBA INYECTORA

53330

32,50€

0,75 5 20 144  
Kg U.S. ft

Cr-V 1/2" 1/4" 5 PCS

- Bomba de inyección BOSCH.  
- TDI.  
- Common Rail.



## CEBADOR INYECCIÓN DIESEL

52801

24,00€

0,13 5 50 1.500  
Kg U.S. ft

- Durante la sustitución de la bomba de inyección, filtros u otras partes, evita el retroceso del combustible hacia el depósito.  
- Posteriormente al montaje de las partes a sustituir permite bombear el combustible hacia la línea de inyección.



## SET PARA EXTRACCIÓN Sonda LAMBDA

51491

141,50€

3,89 5 150  
Kg U.S. ft

- 17x78mm (12PT): Renault.  
- 19x78mm (12PT): VW, Polo, Audi, Seat, Mazda.  
- 20x78mm (6PT): Deschis Japon.  
- 27x78mm (6PT): Deschis Japon.  
- 21x90mm (12PT): Seat, Audi, VW, Skoda, Alfa Romeo, Mitsubishi.  
- 22x78mm (12PT): Seat, Audi, VW, Skoda, Opel.  
- 22x110mm (12PT): Mercedes, Citroen, Peugeot, Ford, Nissan, Mazda, Mitsubishi, Seat, Audi, VW, etc.



14 PCS

INYECCIÓN



## LLAVE PARA EXTRACCIÓN SONDA LAMBDA

52820

0,53

6

36

22mm

43,50€

Kg

kg

ft



CABEZAL ARTICULADO

52822

0,41

5

20

22mm

32,00€

Kg

kg

ft

CABEZAL ARTICULADO



- Llave hexagonal con ventana, permite la extracción de sondas Lambda situadas en lugares de difícil acceso.

## SET DE 7 PIEZAS PARA EXTRACCIÓN DE SONDA LAMBDA

51119

2,05

5

10

200

56,40€

Kg

kg

ft

1/2"

3/8"



- Contenido:  
Vaso de 1/2" de 29x9 a 90mm largo.  
Vaso de 1/2" de 7/8" a 50mm largo.  
Vaso de 1/2" de 27x12 a 78mm largo.  
Vaso de 3/8" de 7/8" x 6 a 90mm largo.  
Vaso de 3/8" de 7/8" x 6 a 80mm largo.  
Vaso de 3/8" de 7/8" a 30mm de largo.  
Vaso de 3/8" de 1" y 1-1/16" a 74mm largo.

## SET REPARADOR DE ROSCAS INTERIORES Y EXTERIORES

54003

1,2

10

88,50€

Kg

kg

Medidas de rosca:

- M14x1,5
- M16x1,5
- M18x1,5
- M20x1,5
- M22x1,5
- M24x1,5
- M27x2,0
- M28x1,5



CrMo

9 PCS

## KIT DE REPARACIÓN DE TUERCAS HELICOIDALES

51896

2,2

5

300

115 PCS

75,00€

Kg

kg

ft



- Contiene por medida:  
Broca.  
Terraaja macho de acabado.  
Insertador de Helicoil.  
Puntero de rotura.  
Set helicoils acero Inox.

- Contenido:  
25 x M5x0.8  
25 x M6x1  
25 x M8x1.25  
25 x M10x1.5  
10 x M12x1.75

51897

2,21

5

378

39 PCS

112,50€

Kg

kg

ft



- Contiene por medida:  
Broca.  
Terraaja macho de acabado.  
Insertador de Helicoil.  
Puntero de rotura.  
Set helicoils acero Inox.

- Contenido:  
9 x M12x1.75  
9 x M14x2  
9 x M16x 2.0

## KIT DE REPARACIÓN DE TUERCAS HELICOIDALES

53041

0,67

10

1.000

- ESPECIAL BUJÍAS.

33,50€

Kg

kg

ft

M14x1,25



51898

125,00€

1,81

4

252

M18x2,5

51899

123,00€

2,12

4

252

M20x2,5



- Contiene:  
Broca.  
Terraaja macho de acabado.  
Insertador de helicoil.  
Puntero de rotura.  
Set espirales acero inox.

## ESTUCHE MÉTRICO CON 60 PIEZAS DE MACHOS Y TERRAJAS COMBINADO MÉTRICO Y PULGADA

50793

2,35 5 185

84,50€



60  
PCS



1 Macho NPT (pulgadas): 1/8-27.  
1 Terraaja TNP (pulgadas): 1/8-27.  
1 Porta machos mixto: M3 ~ M12 y 3/16" ~ 1/2".  
1 Porta machos mixto tipo T: M3 ~ M6 6-32 y 4-40.  
1 Porta terrajas mixto: Ø25mm.  
1 Destornillador.  
1 Juego de galgas métrico para roscar.  
1 Juego de galgas en pulgadas para roscar.  
10 Machos (métricos): M3x0.5, M4x0.7, M5x0.8, M6x1.0, M7x1.0, M8x1.25, M9x1.25, M10x1.0, M10x1.5, M12x1.75.

10 Machos UNC (pulgadas): 4-40, 6-32, 8-32, 10-24, 12-24, 1/4-20, 5/16-18, 3/8-16, 7/16-14, 1/2-13.  
6 Terraajas UNF (pulgadas): 10-32, 1/4-28, 5/16-24, 3/8-24, 7/16-20, 1/2-20.  
10 Terraajas (métricas): M3x0.5, M4x0.7, M5x0.8, M6x1.0, M7x1.0, M8x1.25, M9x1.25, M10x1.0, M10x1.5, M12x1.75.  
10 Terraajas UNC (pulgadas): 4-40, 6-32, 8-32, 10-24, 12-24, 1/4-20, 5/16-18, 3/8-16, 7/16-14, 1/2-13.  
6 Terraajas UNF (pulgadas): 10-32, 1/4-28, 5/16-24, 3/8-24, 7/16-20, 1/2-20.

## ESTUCHE MÉTRICO CON 58 PIEZAS DE MACHOS Y TERRAJAS RECUBIERTAS DE TITANIO

50792

2,59 6 240

93,50€



58  
PCS



1 Macho NPT: 1/8-27.  
1 Terraaja TNP (pulgadas): 1/8-27.  
1 Porta machos mixto: M4 ~ M12.  
1 Porta machos mixto tipo T: M3 ~ M6.  
1 Porta terrajas mixto: Ø25mm O/D.  
1 Destornillador.  
1 Juego de galgas para roscar.

17 Machos: 2x0.4, 3x0.6, 3x0.5, 3.5x0.6, 4x0.75, 4x 0.7, 5x0.8, 6x0.75, 6x1.0, 7x0.75, 7x1, 8x1.0, 8x1.25, 10x1.25, 10x1.5, 12x1.25, 12x1.75.

17 Terraajas: 2x0.4, 3x0.6, 3x0.5, 3.5x0.6, 4x0.75, 4x0.7, 5x0.8, 6x0.75, 6x1.0, 7x0.75, 7x1, 8x1.0, 8x1.25, 10x1.25, 10x1.5, 12x1.25, 12x1.75.

## RECAMBIOS HELICOIL



x5

REF.	DESCRIPCIÓN	€ / x5
52016	Recambio helicoil M5x0,8	2,10 €
52017	Recambio helicoil M6x1,0	2,40 €
52018	Recambio helicoil M8x1,25	2,60 €
52019	Recambio helicoil M10x1,50	3,20 €
52021	Recambio helicoil M12x1,75	3,40 €

REF.	DESCRIPCIÓN	€ / x5
52022	Recambio helicoil M14x2,0	4,50 €
52023	Recambio helicoil M16x2,0	6,60 €
52024	Recambio helicoil M18x2,5	10,60 €
52025	Recambio helicoil M20x2,5	13,00 €

## PROBADOR DE PRESIÓN Y VACÍO

53426

0,9 16

28,00€



VACÍO  
VACUUM 0-28 inHg  
(0-70 cmHg)

PRESIÓN  
PRESSURE 0-0,7 kg/cm<sup>2</sup>  
(0-10 PSIG)

## MEDIDOR DE PRESIÓN DE ACEITE

52754

1,31 5 160

48,50€



- Útil para comprobar la presión de aceite y diagnosticar problemas en el sistema.  
- Incluye 10 adaptadores que cubren la mayoría de vehículos del mercado.

M10x1.0mm	1/8" DIN 2999
M12x1.5mm	1/8" x 27 NPT
M14x1.5mm	1/4" x 18 NPT
M16x1.5mm	3/8" x 20 UNF
M18x1.5mm	1/2" x 20 UNF

## COMPROBADOR DE PRESIÓN DEL TURBO

53489

0,7 5 10

59,80€



-1-3BAR  
2M

## MEDIDOR DE COMPRESIÓN DIESEL PARA CAMIÓN

52685

3,45 6 90

76,00€



0-70 BAR  
0-1000 PSI



- Kit completo para medir la compresión de vehículos diesel.  
- Gran rango de adaptadores para medir en la mayoría de vehículos del mercado.  
- Sistema de enganche rápido para trabajos en puntos de difícil acceso.  
- Adaptador en ángulo y adaptador a roscas de M18 y M24.

- Dispone de válvula de descarga y de sistema de retención de lectura.

## MEDIDOR DE COMPRESIÓN GASOLINA

52488

0,7 5 20 425

24,50€



0-300 PSI  
0-21 kg/cm<sup>2</sup>



- Reloj calibrado de doble lectura (0-300psi, 0-2000kpa) con válvula de descompresión.  
- Su sistema de enganche rápido permite una medición rápida y exacta en puntos de difícil acceso; el adaptador cónico permite el uso en la mayoría de vehículos del mercado.



## COMPROBADOR DE PRESIÓN PARA DIESEL Y GASOLINA

53490

5,5 2 40

252,50€



- Alfa Romeo, BMW, Chrysler, Citroen, Daewoo, Fiat, Ford, Honda, Hyundai, Isuzu, Jeep, Kia, Lada, Lancia, Land Rover, LDV, Mazda, Mercedes, MG, Mitsubishi, Nissan, Peugeot, Renault, Rover, Saab, Ssangyong, Suzuki, Toyota, VAG, Vauxhall/Opel, Volvo.



DIESEL

Ø 10, 12, 14, 18MM



GASOLINA

Ø 10, 12, 14, 18MM



## MEDIDOR DE COMPRESIÓN DIESEL

52489

2,15 6 72

56,50€



- Ford, BMW, Mercedes Benz, VW, Citroën, Mitsubishi, Toyota, Peugeot, Renault, Volvo, Mazda.

0-1000 PSI  
0-70 Kgs./cm<sup>2</sup>



- Kit completo para medir la compresión de vehículos diesel.  
- Gran rango de adaptadores para medir en la mayoría de vehículos del mercado.  
- Sistema de enganche rápido para trabajos en puntos de difícil acceso.  
- Adaptador en ángulo y adaptador a roscas de M18 y M24.  
- Dispone de válvula de descarga y de sistema de retención de lectura.



M18x1.5mm  
M24x2.0mm  
M24x1.5mm

M10x1.0x68mm  
M10x1.25x54mm  
M10x1.25x68mm  
M12x1.25x45mm

## MEDIDOR DE COMPRESIÓN DIESEL

51893

557,00€

0-1000 Psi  
0-70 Kgs./cm<sup>2</sup>

4,25  
3  
45



- Diagnóstico de compresión para sistemas de inyección diesel.  
- Rango de trabajo hasta 70kg/cm<sup>2</sup> (1.000PSI).  
- Reloj de medición recubierto en goma, con adaptadores en ángulo y prolongadores para trabajos en punto de difícil acceso.  
- Apto para uso en la mayoría de motores diesel del mercado.

- Con adaptadores de gama Alfa, BMW, Chrysler, Daewoo, Fiat, Ford, Hyundai, Isuzu, LandRover, LDV, Mazda, Mercedes, Mitsubishi, Nissan, Opel, PSA, Renault, Suzuki, Saab, Toyota, VAG, Opel, Volvo diesel.  
- Inyector: M20, M22, M24 y Ford.

## COMPRESÍMETRO PARA CIRCUITOS DE GASOLINA

52599

4,4 5

215,00€



0-145 PSI

0-1000 KPA



- Contiene todos los elementos necesarios para comprobar la inyección de combustible en la mayoría de los coches nacionales y extranjeros.  
- Cuenta con un gran manómetro de 3-1/2" con lecturas duales de 0-145 psi y 0-1000 KPA y un manómetro de 2-1/2" con lecturas duales.  
- Todos los adaptadores, manómetros y conjuntos de mangueras cuentan con un sistema de acoplamiento rápido.



## COMPRESÍMETRO PARA CIRCUITOS DE GASOLINA

53997

1,35 5

47,50€



- Permite la detección de fallos en el sistema de combustible.  
- Compatible con los sistemas de inyección Schrader.



1 Longitud: 25.5cm  
Diámetro exterior: 1.2cm  
Diámetro interior: 0.6cm

2 Longitud: 29.5cm  
Diámetro exterior: 1.2cm  
Diámetro interior: 0.6cm

3 Longitud: 110cm

## SET REPARADOR DE ROSCAS DE CALENTADORES

52076

0,85 10

111,00€



- A. Inserción de corte M14 x 1,25 (para roscas de M12 x 1,25) - 1ud.
- B. Inserción de corte M12 x 1,25 - 1ud.
- C. Inserción de corte M12 x 1,0 (para roscas de M10 x 1,25) - 1ud.
- D. Inserción de corte M10 x 1,25 - 1ud.
- E. Inserción de corte M10 x 1,0 (para roscas de M8 x 1,0) - 1ud.
- F. Inserción de corte M8 x 1,0 - 1ud.

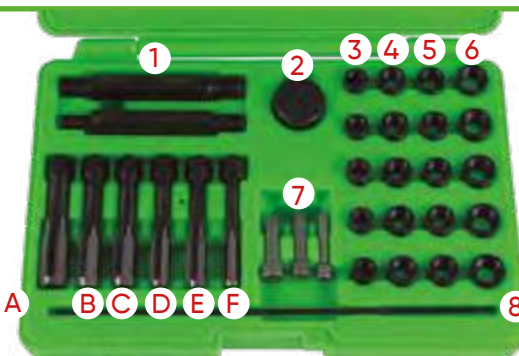

- 1. Herramienta de inserción - 2uds.
- 2. Mango para pieza 8 - 1ud.
- 3. Rosca M8 x 1,0 - 5uds.
- 4. Rosca M10 x 1,0 - 5uds.
- 5. Rosca M10 x 1,25 - 5uds.
- 6. Rosca M12 x 1,25 - 5uds.
- 7. Cabezales de inserción - 3uds.
- 8. Varilla de inserción de rosca - 1ud.

REF.	DESCRIPCIÓN			€
11893	Helicoil M8x1,0	0,01	5	7,00 €
11894	Helicoil M10x1,0	0,01	5	7,00 €
11895	Helicoil M10x1,25	0,05	5	8,65 €
11896	Helicoil M12x1,25	0,01	5	8,80 €

## EXTRACTOR / REPARADOR DE CALENTADOR

52305

2,79 10 180

93,50€



16 PCS



- Extractor de bujías de precalentamiento de 16 piezas.
- Este set es útil para la extracción del calentador roto o atascado. Universal e ideal para motores Mercedes-Benz CDI.
- Extrae los calentadores rotos o dañados M8 y M10.
- Incluye machos de rosca 1/4" M8 y broca escalonada de alta resistencia de doble tamaño M8 y M10.

## JUEGO DE EXTRACTORES DE PUNTA DE ELECTRODO DE CALENTADORES

52815

96,50€

0,95  
5  
280



- Útiles especialmente diseñados para extraer puntas de electrodo de calentador en caso de rotura durante el proceso de extracción.
- Facilita la extracción sin necesidad de levantar la culata.

## EXTRACTOR DE CONEXIONES DE CALENTADOR

52816

0,27 6 36

25,50€



52817

0,28 6 36

23,50€



- Alicates útiles para extraer los conectores en calentadores Diesel.
- Indicados para la extracción de forma rápida.
- Con los conectores localizados en puntos de difícil acceso, los alicates permiten realizar la operación sin riesgo de dañar el calentador u otras partes del vehículo.
- Mango engomado ergonómico.

## SET DE VASOS TWIST DE 1/2" PARA EXTRACCIÓN DE TUERCAS / TORNILLOS SEGURIDAD

52153

0,93 5 20 300

42,00€



17, 19, 21, 23, 27mm



1/2"



## SET DE VASOS TWIST DE 3/8" PARA EXTRACCIÓN DE TUERCAS / TORNILLOS SEGURIDAD

51998

0,69 20 360

31,50€



10 PCS

52962

0,72 5 20 1.500

44,00€



11 PCS



3/8"

CR-MO



9, 10, 11, 12, 13, 14, 15, 16, 17, 19mm

6, 8, 10, 11, 12, 13, 14, 15, 16, 17, 19mm



## SET DE TORNILLOS DE SEGURIDAD PARA BMW

53208

0,95 5 20

113,00€



41-60

BMW

22

PCS



- BMW Serie 1 F20/F21.
- BMW Serie 3 F30/F31.
- BMW Serie 4 F32/F34/F36.
- BMW Serie 5 F10/F11.
- BMW Serie 6 F12/F13.
- BMW Serie 7 F01/F02/F04.

## SET EXTRACTOR DE TORNILLOS DE SEGURIDAD PARA VW

53207

1,55 5 10 330

99,00€



VW

23

PCS



- |            |             |
|------------|-------------|
| b51 / 6pt  | b62 / 17pt  |
| b52 / 7pt  | abc0 / 10pt |
| b53 / 8pt  | abc1 / 11pt |
| b54 / 9pt  | abc2 / 13pt |
| b55 / 10pt | abc3 / 14pt |
| b56 / 11pt | abc4 / 15pt |
| b57 / 12pt | abc5 / 16pt |
| b58 / 13pt | abc6 / 17pt |
| b59 / 14pt | abc7 / 19pt |
| b60 / 15pt | abc8 / 20pt |
| b61 / 16pt | abc9 / 21pt |

## SET EXTRACTOR DE TORNILLOS DE SEGURIDAD PARA BMW

52802

0,62 20

49,50€



- Útil para sacar los tornillos de seguridad.



10

PCS

BMW

- 30/13 PT
- 31/15 PT
- 32/16 PT
- 33/17 PT
- 34/18 PT
- 35/19PT
- 36/20 PT
- 37/21 PT
- 38/22 PT
- 40/23 PT



## SET EXTRACTOR DE TORNILLOS DE SEGURIDAD PARA GRUPO VAG

52823

0,94 5 20

99,00€



22

PCS

VAG

A, B, C, E, F, G, H, I, J, L, M, N, P, Q, R, S, T, V, W, X

- Set especialmente diseñado para extraer los tornillos de seguridad en llantas de vehículos Volkswagen.
- Cubren prácticamente el 100% de la flota de vehículos VW del mercado.
- Sirve para el 100% de vehículos con tornillo antirrobo tipo "flor".



## SET DE TORNILLOS DE SEGURIDAD PARA MERCEDES

53328

0,6 5 20

66,00€



MERCEDES

5A, 5C, 5D, 5E, 5F, 5G, 5N, 5L, 5P, 5X

12

PCS



- Clase A, B, C, GLK, CLC, CLS, CLK, E, SL, SLK, M, C300, C250, C350, E320, 204, 211, 212, R.

## SET DE REPARACIÓN DE ROSCAS PARA TORNILLOS DE RUEDA

53652

0,94 5 10 240

47,00€



- Set de útiles para reparar y reacondicionar tornillos de rueda, así como el anclaje del mismo a la rosca hembra del vehículo; útil en roscas parcialmente dañadas.

- M12x1.25 - PSA
- M12x1.5 - MERCEDES BENZ / BMW
- M12x1.75 - VOLVO
- M14x1.5 - VAG



## EXTRACTOR DE BOBINA DE ENCENDIDO PARA VW

51495

53,50€

0,96  
20  
200



VW



- Quitar y instalar las bobinas de encendido con tapa de motores de inyección VW CYL 8 y 12 / 5 y 6 CYL, VW GOLF, BORA, 4 y 5 CYL, VW Passat, 6 CYL, Sharan VW, Touareg, Phaeton.
- Extraer e instalar las bobinas de encendido con etapa de potencial VW Polo, Golf 1.4, 1.6i, 1.4i CADDY, BORA 1.4, 1.6i Phaeton, Passat, Touran 1.6i, Transporter T4.

### DESPIECE DISPONIBLE

DISCO REPARADOR		TORNILLO REPARADOR	
REF.	DESCRIPCIÓN	€	€
14344	M12x1.25	0,49 20	11,00€
14345	M12x1.5	0,50 20	11,00€
14346	M14x1.5	0,46 20	11,00€
14340	M12x1.25 - PSA	0,05 20	10,50€
14341	M12x1.5 - MERCEDES / BMW	1,14 20	10,50€
14342	M12x1.75 - VOLVO	1,12 20	10,50€
14343	M14x1.5 - VAG	1,29 20	10,50€

## EXTRACTOR DE TORNILLOS DE AJUSTE

51496

0,09 12 72 2.000

8,00€



5

PCS

- Nº 1: 1/8" - 1/4" (M 3-6)
- Nº 2: 1/4" - 5/16" (M 6-8)
- Nº 3: 5/16" - 7/16" (M 8-11)
- Nº 4: 7/16" - 9/16" (M 11-14)
- Nº 5: 9/16" - 3/4" (M 14-18)



- Fabricados a partir de un tratamiento térmico de acero al cromo molibdeno.
- Consigue una rápida eliminación con la ayuda de las hélices actuando como tornillo.

## SET EXTRACTOR DE MACHOS DE ROSCAR ROTOS

53502

0,55 5 20

33,50€



9

PCS

- #2 M5
- #3 M6
- #4 M8
- #5 M10
- #6 M12
- #7 M14
- #8 M16
- #9 M20
- #10 M22



## SET VASOS EXTRACTORES DE ESPÁRRAGOS DE 1/2"

52833

0,82 5 20

39,30€



1/2"



6, 8, 10, 12mm



### DESPIECE DISPONIBLE

REF.	DESCRIPCIÓN	Kg	L	fl	€
14211	6mm	0,10	20	100	11,00€
14212	8mm	0,10	20	100	12,00€
14213	10mm	0,20	20	100	12,00€
14214	12mm	0,20	20	100	14,00€



## SET DE ABOCARDADO DE TUBERÍAS

52700

0,93 6 12 528

20,50€



3/16, 1/4, 5/16, 3/8, 1/2

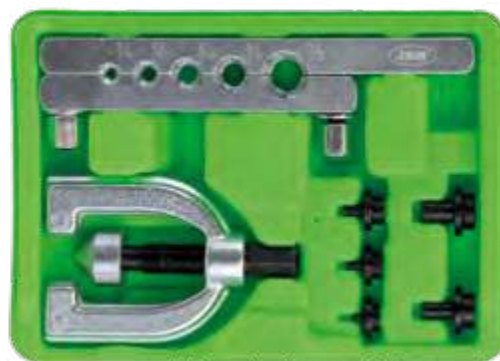

## LLAVES DE BUJÍA ARTICULADAS

52691

0,79 24 480

53,50€



3/8"



82mm



8, 9, 10, 12, 14, 16mm

CON SISTEMA MECÁNICO DE SUJECIÓN

## LLAVE DE BUJÍA IMANTADA

52317

0,39 12 48 2.880

19,00€



Ø16mm

↑250mm

3/8"



52316

0,29 12 48 2.880

18,00€



Ø14mm



## VASO DE BUJÍA HEX.

10054

2,50€



16mm

10055

3,00€

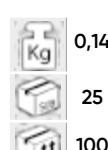

21mm



1/2"



GOMA EN EL INTERIOR

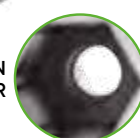



## PALANCA ARTICULADA PARA AFLOJAR POLEAS

**52961**  
82,50€

2,38 8 192  
Kg fl

1/2"

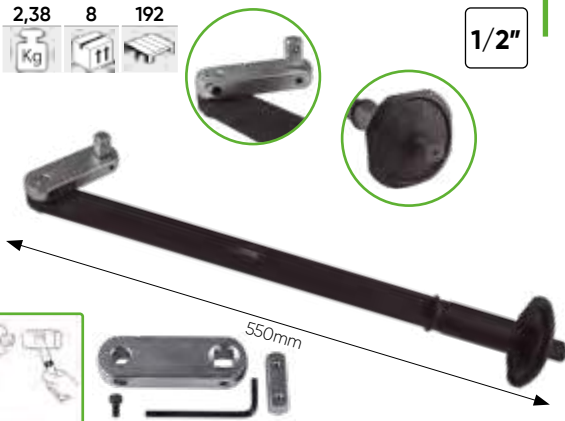

## PALANCA PARA AFLOJAR POLEAS

**52690**  
39,00€

1,54 10 280  
Kg fl

3/8"

1/2"

- Palanca de 230mm con cuadrado de 1/2".
- Palanca de 585mm con cuadrado de 3/8".
- 3 llaves abiertas de 13, 14, 15mm y con cuadrado de entrada de 3/8".
- 4 vasos hexagonales de 3/8" y 13, 15, 16, 18mm.

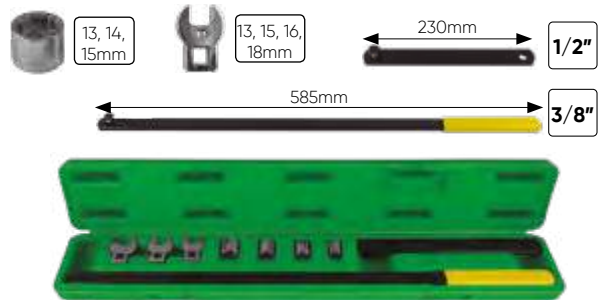

## JUEGO DE LLAVES CURVADAS PARA EXTRACCIÓN POLEAS 12 CANTOS

**52832**  
65,00€

1,35 5 160  
Kg fl

12, 13, 14, 15, 16,  
17, 18, 19mm

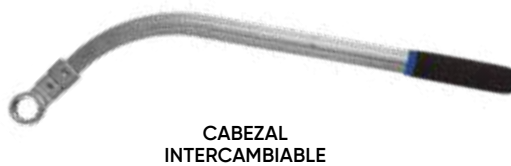

CABEZAL INTERCAMBIABLE



## SET DE EXTRACCIÓN DE POLEAS DE 30 PIEZAS

**52293**  
89,00€

3,11 5 130  
Kg fl

30  
PCS



- 1/2" T50 c/33 dientes 17mmx33T - 113mmL.
- 1/2" M10 c/33 dientes 17mmx33T - 113mmL.
- H15x33 dientes 15mmx33T - 31mmL.
- H22x33 dientes 22mmx33T - 30mmL.
- H22 - 30mmL.
- H17x4 Pins especial H17x4Pins - 30mmL.
- 1/2" Dr. xH10 Bit adaptador.
- H8xH10 Punta 75mmL.
- H10xH10 Punta 75mmL.
- M8xH10 Punta 75mmL.
- M10xH10 Punta 75mmL.
- T40 xH10 Punta 75mmL.
- T50xH10 Punta 75mmL.
- M10xH12 Punta 64mmL.
- Especial H22xH28 - 30mmL.
- Especial H19xH28 - 30mmL.
- 1/2"Dr.xM10 punta M10 - 143mmL.
- 3/8"Dr.xM10 c/31 dientes - 12mmx31T- 83mmL.
- Especial H21xH28 - 30mmL.
- Especial H17 - 35mmL.
- Especial H38x3 Pins-17mmL.
- Especial 15mmx33T- 30mmL.
- H10xFH10 - 71mmL.
- T50xH12 Bit 64mmL.
- Especial H17xH21-30mmL.
- Especial H15xH28 - 30mmL.
- 3/8"Adaptador x10mm.
- 1/2"Dr.xT50 punta T50 - 143mmL.
- 1/2"Dr.xT50 punta T50 - 204mmL.
- 1/2"Dr.xM10 punta T50 - 204mmL.

## JUEGO DE EXTRACTOR POLEAS DE 18 PIEZAS

**51259**  
53,50€

2,10 5 180  
Kg fl

18  
PCS

- 3 x Vasos combinados: T50x113mm (vaso de 1/2"), M10x113mm (vaso de 1/2"), M10x90mm (vaso de 3/8").
- 1 x Vaso dentado: M10x140mm.
- 2 x Adaptadores hexag. 19 y 22mm.
- 3 x Vasos hexagonales: 22x28mm, 19x28mm, 21x28mm.
- 1 x Adaptador Hex. 1/2" x 10mm.
- 1 Punta M10x12x64L.
- 6 x Puntas 10mm (vasos hex.) x 75mm: Medidas: T40, T50, M8, M10, H8, H10.



### DESPIECE DISPONIBLE

**10494** 6,50€  
VASO ALARGADOR  
14cm

**10495** 3,00€  
PUNTA H10

**10496** 3,00€  
PUNTA H8

**10497** 3,00€  
PUNTA M10

**10498** 3,00€  
PUNTA M8

**10499** 3,00€  
PUNTA T40

**10500** 3,00€  
PUNTA T50

**10502** 3,50€  
PUNTA M10 TORX

**10501** 8,10€  
VASO PUNTA  
XZN M10 90mm

**10485** 8,10€  
VASO PUNTA  
XZN M10 110mm

**10486** 8,00€  
VASO PUNTA  
TORX T50 110mm

## EXTRACTOR DE TUERCAS

**51368**  
18,00€

0,41 10 50 1.000  
Kg Sd Tl

∅  
↑ 42mm  
↓ 33mm



## EXTRACTOR PARA ESPÁRRAGOS

**51414**  
11,00€

0,59 5 40 1.440  
Kg Sd Tl

∅  
↑ 20mm  
↓ 15mm



## EXTRACTOR/INSTALADOR DE RETENES DE CIGÜENAL (GRUPO VAG)

**53875**  
125,00€

1,85 4  
Kg Tl



**MARCAS** VW: Golf, Touran  
AUD: A3, A4

**HERRAMIENTAS OEM** OEM T10134.

**CÓDIGOS DE MOTOR** 1.4i turbo  
1.4, 1.6 inyección directa de gasolina  
1.9, 2.0 SDI  
2.0 diesel common rail

## EXTRACTOR DE TUERCAS AXIALES

**51369**  
22,50€

0,55 6 36  
Kg Sd Tl

∅  
↑ 42mm  
↓ 35mm



## EXTRACTOR DE POLEAS ARMÓNICO

**52624**  
25,50€

1,26 5 360  
Kg Tl

- Para extraer poleas, cajas de cambio, volantes y cigüeñal.
- Material: acero al carbono.
- ∅ agujeros: 35-85mm.
- Rosca central con pivote flotante y extraíble.

- Contiene:  
2 x tornillo 5/16" de 4".  
2 x tornillo 1/4" de 3".  
3 x tornillo 1/4" de 2".  
3 x tornillo 5/16" de 2".  
1 x 5" tornillo de presión de aleación de aluminio.  
1 x punta giratoria 3/4".



## EXTRACTOR DE POLEAS ACANALADAS

**51500**  
28,00€

1,55 5 10 640  
Kg Sd Tl

40-168mm

- Apto para el uso en cigüeñales, alternadores, unidades de AACCC y bombas de agua.
- Los brazos del perfil bajo permiten un fácil acceso a zonas difíciles del motor.
- Diseñado para la extracción del cigüeñal acanalado, agarrotado y de poleas auxiliares.



## EXTRACTOR DE POLEAS UNIVERSAL

**53664**  
32,50€

0,80 10  
Kg Tl

- Uso universal.
- Opción de multiposición para adaptarse a la mayoría de poleas.
- Ideal para trabajar en áreas estrechas, ahorrando tiempo de trabajo.

- Medidas:  
Eje de 16mm de diámetro con bola centradora y cabeza de tornillo hexagonal de 24mm.

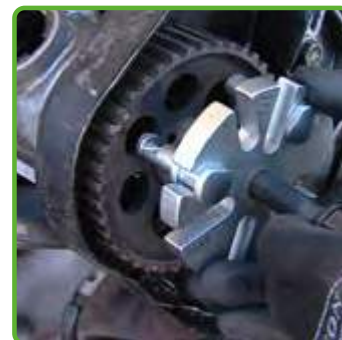

## ÚTIL DE EMBRAGUE ESPECIAL FIAT

**52190**  
8,00€

0,39 10 1.000  
Kg Sd Tl

220x110mm

- Especificaciones:  
Facilita el acceso al vástago de la horquilla para su extracción y la posterior sustitución del disco.  
Útil para desmontar la horquilla en embragues de Fiat Ducato.  
Reduce el tiempo de trabajo.  
Evita desmontar el cambio para cambiar el embrague.
- Rosca: 1,5cm de largo x ∅ 0,5cm.



## GANCHOS PARA EXTRACCIÓN DE JUNTAS

**53053**  
10,00€

0,21 10 50 1.000  
Kg Sd Tl

1x15.5cm / 1x16.5cm / 1x12cm





## SET DE 12 PIEZAS PARA LA EXTRACCIÓN DE AIRBAGS

51501

0,88 5 20 240

43,50€



- Puntas 0.5 PC 1/4" x 87mm (L):  
2x Torx: T25 (para BMW), T30 (para Audi, Opel, Renault, VW).  
2x Torx (inviolable): T25H (Para BMW), T30H (Para AUDI), BMW, Mercedes, Opel).  
1x Hex: 5 mm (Para Audi).

- 0.7 PC Herramienta extracción:  
1x para Airbag conductor. 1999-04 nuevo estilo de carrocería de VW Passat, Jetta, Golf.  
2x para VW Passat B5, Polo, Lupo/Audi A4, A6, Skoda Superb.  
2x para VW Golf 4, New Beetle, Seat, Skoda Fabia, AB Oktavia BJ.99.  
1x para Para VW Golf 4 (BJ, 1998-2004), VW Passat BJ.1997 AB, AB Bora BJ.1999.  
1x para U.A VW-Modelle: AB Passat BJ.2000.

12  
PCS

## SOPORTE DE AJUSTE PARA BRAZO DE SUSPENSIÓN

51902

5,26 1 52

99,00€



- Medidas:  
118cm largo.  
Ø Diám. Tubo: 3,5cm.  
Distancia de anclajes:  
50, 45, 40, 35, 30 cm.  
Anclaje de 15x13cm.



RECAMBIO DE ANCLA  
DE SUJECIÓN PARA  
REF. 51902

10953

12,50€



0,83 1  
Kg cbm

## KIT DE HERRAMIENTAS PARA EXTRACCIÓN DE BRAZOS DE DIRECCIÓN

52639

5,05 4 76

117,50€



Ø 30-35mm  
Ø 35-40mm  
Ø 40-45mm



## ALINEADOR DE DIRECCIÓN

51991

1,15 10 120

48,00€



- Una viga para montar instrumentos de medición sobre ruedas, p. Ej., Al ajustar la convergencia, la inclinación, etc.

- Largo total abierto: 1950mm.  
- Largo total cerrado: 1100mm.  
- Medida de tornillo: M6x15mm.  
- Tubo exterior de 20x20 de aluminio.  
- Tubo interior de 16x16 de hierro cincado.

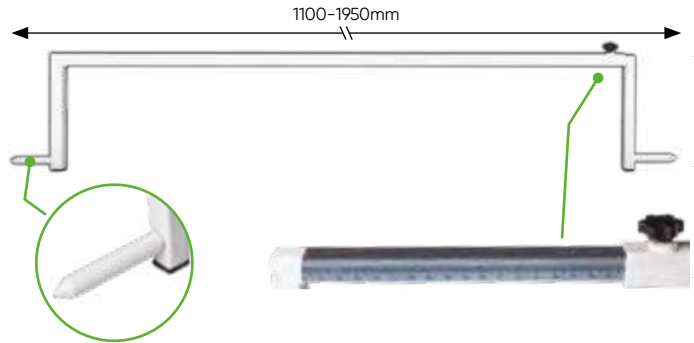

EXTRACTORES

## HERRAMIENTAS EXTRACCIÓN BRAZO DE DIRECCIÓN

52640

1,81 4 200

46,50€



Ø 28-35mm

52641

2,28 4 200

49,00€



Ø 35-45mm



## EXTRACTOR DE BRAZOS DE DIRECCIÓN

52874

1,2 4 20 1.500

68,50€



Ø 9-20mm

52875

1,27 20 1.500

72,50€



Ø 14-23mm



## EXTRACTOR DE RÓTULAS HIDRÁULICO

**53384**  
145,00€

7,3 2 62  
Kg fl

- Apertura: 100mm.  
- Ancho: 35mm.

10kg



HUSILLO

**15253**  
57,00€

## JUEGO DE 5 EXTRACTORES DE RÓTULA

**51123**  
88,50€

5,29 2 96  
Kg fl



- Permite la fácil extracción de los tipos más populares de articulaciones de rótula y demás.  
- El tipo de separador de la prensa de la junta permite el retiro de la junta de rótula sin daño a los cargadores y a otras piezas que otro tipo de extractores pueden causar.

## SET EXTRACTOR-SEPARADOR DE RÓTULA

**51490**  
32,00€

1,88 5 240  
Kg fl

- Horquillas hechas de acero cromo vanadio forjado de alta resistencia.  
- Ambos mangos son intercambiables.  
- 1 mango diseñado para utilizarse con martillo neumático.

- Contenido:  
1 mango para su uso con un martillo.  
3 horquillas: 11/16, 15/16" y 1-1/8".



## COMPROBADOR MECÁNICO DE RÓTULAS

**52541**  
43,50€

2 10 120  
Kg fl

- Para detectar juego en: Cojinetes, silentblocks, cojinetes de rueda, articulaciones axiales, palieres, estabilizadores, etc.



## EXTRACTOR UNIVERSAL DE BOLA

**52642**  
30,50€

1,28 5 20  
Kg fl

- Apertura Max: 60mm.  
- Apertura Min: 20mm

17 - 22mm



2 MEDIDAS AJUSTABLES

## EXTRACTOR DE RÓTULAS

**52699**  
18,00€

0,77 5 30 1.050  
Kg fl

- Apertura: 15-50mm.

Ø 18-22mm



## JUEGO DE EXTRACTORES DE GUILLOTINA

**51125**  
81,50€

4,73 5 160  
Kg fl

Capacidad de las guillotinas:

- Set Pulgada:  
1/4", con 30mm y 50mm.  
Tornillo de 3/8" de 95x125 - 24 UNF.  
Cabeza de 3/8" x 16 UNC.

- Set 2 Pulgadas:  
1/4" - 3 1/2", con 50x75mm.  
Tornillo de 1/2" de 12.7x135 20 UNF.  
Cabeza de 3/8" x 16 UNC.



## EXTRACTOR DE GUILLOTINA

**52626**  
39,50€

2,5 5 800  
Kg fl

75 - 105mm

- Para extraer rodamientos en coches y vehículos comerciales ligeros.  
- Extrae cajas de cambio, poleas y volantes fácilmente.

**52627**  
82,50€

5,27 2 231  
Kg fl

105 - 150mm





## EXTRACTOR DE COJINETES CON 2/3 GARRAS INTERCAMBIABLES

**53701**

173,00€

8,45

Kg

1

fl

44

fl

13  
PCS

- Rango extractor 2 patas: 45-120mm.
- Rango extractor 3 patas: 50-130mm.
- Profundidad de las garras: 100, 200, 250mm.

- Contiene:
- Guía central de 3 garras.
- Guía central de 2 garras.
- Espárrago de 275mm.
- Espárrago de 165mm.
- Garras de agarre largo: 250mm.
- Garras de agarre medio: 200mm.
- Garras de agarre corto: 100mm.

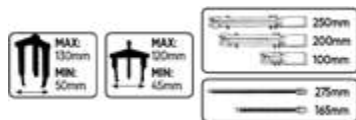

**14611** 0,11  
PUNTA GARRA PARA REF. 53701 12,00€ Kg

**14612** 0,18  
TORNILLO PARA REF. 53701 11,00€ Kg  
165mm

**14613** 0,29  
TORNILLO PARA REF. 53701 13,50€ Kg  
275mm

## EXTRACTOR DE COJINETES CON 3 JUEGOS DE GARRAS

**51122**

154,50€

4,5

Kg

5

fl

120

fl

- Contiene:
- Guía Central.
- Espárrago.
- Garras agarre corto.
- Garras agarre medio.
- Garras agarre largo.



**11492** 0,24  
36,50€ Kg

115-60mm

**11493** 0,56  
39,00€ Kg

230-170mm

**11494** 0,69  
42,30€ Kg

280-220mm

PUNTA GARRA PARA REF. 51122

**13679** 0,1 5 50  
10,50€ Kg fl fl

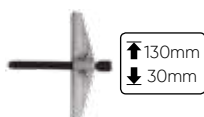

## JUEGO DE EXTRACCIÓN DE COJINETES

**51124**

99,00€

3,29

Kg

5

fl

120

fl

- Contiene:
- Extractor Universal (38,5mm).
- Adaptador de 3/8" a 1/2" (10-14mm).
- Adaptador de 9/16" a 11/16" (15-19mm).
- Adaptador de 5/8" a 1" (18-25mm).
- Adaptador de 1" a 1 1/4" (25-32mm).



## EXTRACTOR DE COJINETES CON ESFERAS FALSAS

**53062**

99,00€

2,41

Kg

5

fl

180

fl

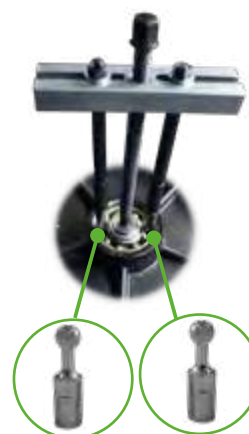

5, 6, 8, 9,  
11, 12,5mm

## EXTRACTOR DE DOS PATAS

**52727**  
30,00€

0,2 5 10 1.152  
Kg S.B. fl

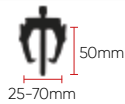

**52728**  
84,50€

1,23 5 10 500  
Kg S.B. fl

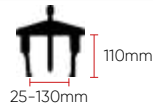

**52729**  
144,50€

3,4 3 240  
Kg fl

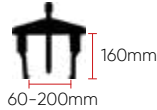

**52730**  
299,50€

8,64 2 72  
Kg fl

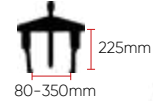

## EXPOSITOR DE EXTRACTORES DE RÓTULA

**53146**  
30,50€

0,7 5 10 200  
Kg S.B. fl



- Extractores no incluidos.

## EXTRACTOR DE 3 PATAS

**52731**  
43,50€

1,08 4 24 576  
Kg S.B. fl

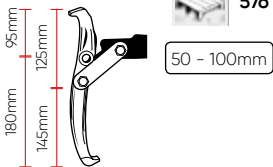

**52732**  
74,50€

2,53 4 12  
Kg S.B. fl

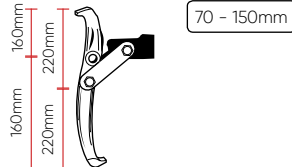

**52733**  
147,50€

5,19 4 72  
Kg S.B. fl

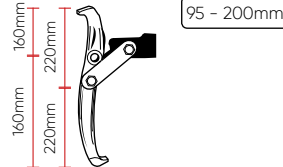

## EXTRACTOR DE 3 GARRAS CONVERTIBLE EN 2 REVERSIBLE

**52010**  
53,00€

0,48 4 40 360  
Kg S.B. fl

- Medida de la Garra: 90mm.
- Medida del pasador: 124mm.
- Uña de agarre: 12mm.
- Ancho de la cruz: 66mm.
- Profundidad: 75mm.



**52296**  
106,50€

1,57 4 8 120  
Kg S.B. fl

- Medida de la garra: 132mm.
- Medida del pasador: 217mm.
- Uña de agarre: 14mm.
- Ancho de la cruz: 95mm.
- Profundidad: 110mm.



**52298**  
154,50€

2,65 6 396  
Kg fl

- Medida de la garra: corta 134mm, larga 207mm.
- Medida del pasador: 218mm.
- Uña de agarre: corta 13mm, larga 15mm.
- Ancho de la cruz: 95mm.
- Profundidad: 110 - 180mm.

GARRA CORTA Y LARGA



**52297**  
149,00€

3,33 6 48  
Kg fl

- Medida de la garra: 210mm.
- Medida del pasador: 313mm.
- Uña de agarre: 15mm.
- Ancho de la cruz: 152mm.
- Profundidad: 180mm.



## SET DE 52 PIEZAS PARA EXTRACCIÓN DE EQUIPOS DE AUDIO

**53388**  
90,00€

1,5 5 120  
Kg fl

**52**  
PCS



## JUEGO DE ACCESORIOS PARA EXTRACCIÓN DE EQUIPOS AUDIO

**51126**  
12,00€

0,2 10 100 1.320  
Kg S.B. fl

- Blaupunkt, Peugeot, Clarion, Skoda, Alpine, BMW, Opel, Audi, Grundig VDO, JVC, Pioneer, Volkswagen, Mercedes, Porsche, Renault, Becker.



- Blaupunkt, Clarion, Skoda, BMW, Audi, Grundig, JVC, Pioneer, Volkswagen, Mercedes, Opel Doppel-Kugel-Inbus, Porsche, Becker, Kenwood, Sony, Panasonic, Fiat Brava, Ford.



## SET DE 23 EXTRACTORES DE TERMINALES

53393

1,60 5 110

118,00€



23  
PCS



- BMW, Audi, Volkswagen, Mercedes, Opel, Porsche, Jaguar, Saab, Seat, Ford, Skoda, Renault, Citroën, Chrysler, Fiat, Honda, Mazda, Mitsubishi, Toyota.

## EXTRACTOR DE SILENTBLOCK DELANTERO PARA VAG

52432

1,32 5 300

35,00€



- Útil para VW POLO modelo 2002.  
- Facilita el cambio de los bujes de goma del eje delantero.



## SET DE 19 EXTRACTORES DE TERMINALES

53391

0,55 10

74,50€



A, B, C, D, E, F, G, H, I, J, K, L, A1, B2, C3, D4, E5, F6, G7

19  
PCS



## EXTRACTOR DE SILENTBLOCK PARA VAG

52270

3,18 4 96

99,50€



- Contiene:  
Eje, extensión de eje, tuerca de empuje M10x1,25.  
Cabezal adaptador de acero al carbono.  
Separador.  
Pieza de presión.  
Mandril de centrado de aleación de aluminio.



## SET DE 10 VASOS DE 1/2" ESPECIALES PARA AUTOMOCIÓN

53669

0,70 5 20

45,00€



TOYOTA, NISSAN, RENAULT, OPEL ASTRA G/ZAFIRA, SMART, CITROËN, PEUGEOT, HONDA CIVIC

### CONTIENE

	10S para engranaje intermedio Toyota		14 mm para pinza de freno Opel Astra G, Opel Zafira y Smart
	6S para embrague, culata y eje de equilibrado de Nissan y Renault		10 mm para sistemas de freno y bomba de combustible Nissan
	8S para embrague, culata y eje de equilibrado de Nissan y Renault		12.5 mm para sistemas de freno y bomba de combustible Nissan
	12S para embrague, culata y eje de equilibrado de Nissan y Renault		19 mm para pinza de freno de Peugeot, Renault y Citroën
	8TS para el eje de equilibrado de Nissan		20 mm para el brazo de control inferior de Honda Civic



## SET DE VASOS CON ALMENAS EXTERIORES

52834

3,73 5 1.500

186,50€



- Set de vasos para la extracción de tuercas ranuradas en vehículos industriales.

11  
PCS

1/2"

CR-MO

mm

22x3,3  
26x3,8  
30x4,3  
33x4,0  
37x4,8  
44x5,3  
50x5,8  
56x5,8  
63x6,3  
69x6,8  
75x6,8



## SET DE VASOS CON ALMENAS INTERIORES

52835

5,2 3 1.500

272,00€



- Set de vasos para la extracción de tuercas ranuradas en vehículos industriales.

10  
PCS

1/2"

mm

26x5,3  
1,2x6,25  
34,2x6,3  
38,2x6,65  
42,2x7,3  
50,1x8,25  
58,2x9,8  
74,6x11,9  
82,2x13,25  
87,7x13



# EXTRACTOR UNIVERSAL DE RETIRADA / INSTALACIÓN DE BUJES, RODAMIENTOS Y SILENTBLOCK

52494

226,50€



- Para instalar y desinstalar casquillos y cojinetes de suspensión.
- Contiene manguitos de diferentes tamaños y barras roscadas de diferentes métricos.
- Medidas: M10, M12, M14, M16, M18.

**Kg** 17,35  
**fl** 1  
**fl** 36

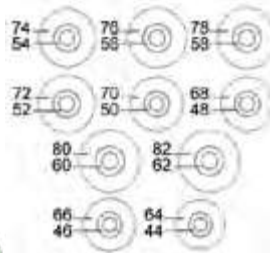

12926 M10

21,50€

12929 M16

23,00€

12927 M12

21,50€

12930 M18

23,50€

12928 M14

22,00€

## JUEGO DE DISCOS DE MONTAJE PARA RODAMIENTOS

53058

177,00€



**Kg** 8,19  
**fl** 1  
**fl** 102

220mm

12mm

## JUEGO DE EXTRACCIÓN E INSTALACIÓN DE RODAMIENTOS

53056

126,50€

8,33 2 68

**Kg** **fl** **fl**

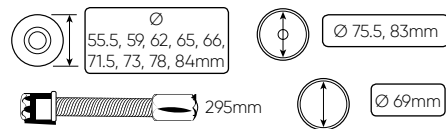
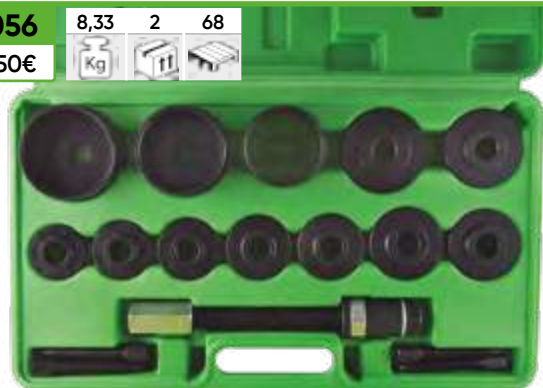

## JUEGO PARA LA INSTALACIÓN DE RODAMIENTOS

51349

35,00€

1 10 315  
**Kg** **fl** **fl**



42 - 38mm  
40 - 35mm  
36 - 32mm  
30 - 28mm  
24 - 22mm  
27 - 25mm  
18 - 16mm  
20 - 18mm  
22 - 20mm  
12 - 10mm  
14 - 12mm  
16 - 14mm  
17 - 15mm

- Adaptadores de mantenimiento para tuerca estriada.
- Apto para todo tipo de buje y rodamiento.

## JUEGO PARA LA INSTALACIÓN DE RODAMIENTOS Y RETENES

53059

47,00€

1,56 5 10 240  
**Kg** **fl** **fl** **fl**



395, 44.5, 50, 59, 63, 65, 72, 76, 81mm



## KIT EXTRACCIÓN E INSTALACIÓN RODAMIENTOS

52551

150,50€

10,42 2 70

**Kg** **fl** **fl**



- Tornillo reforzado para uso con herramienta de impacto.
- Eje de acero-fosfato para evitar la corrosión.
- Adecuado para desmontar e instalar grandes rodamientos industriales.
- Perno: 27mm
- Tuerca: 32mm
- Cilindros: 76, 82, 92, 101mm



Número	955-08	955-11	955-07	955-12	955-13	955-14	955-09	955-15	955-06	955-17	955-18	955-19	955-16
Diámetro (mm)	55.7	63.3	67.8	70.7	71.9	71.7	72.8	73.4	74.7	77.4	81.4	83.3	88.4



## SET EXTRACTOR DE BRAZO LIMPIAPARARBRISAS

53463

1,65 10 180

93,50€



**VW:** Polo, Lupo, Touareg, Porsche Cayenne.  
**Opel:** Astra G, Zaphira B, Corsa C, Vectra C.  
**Honda:** Jazz, CRV, FRV, Accord, Turnier.  
**BMW:** 5° Modelo a partir de E 39 hasta 2005.  
 7° Modelo a partir de E 38 hasta 2005.  
**Audi:** A3, A4, A5, A6, Audi Q7.  
**Ford:** Galaxy, Alhambra.  
**Mercedes:** A-Class, B-Class.

- Diseñado con patas finas y extremos acabados en latón para prevenir cualquier tipo de daño en la carrocería, pintura o vidrio.
- Aplicable a la mayoría de vehículos del mercado.
- Su manejo permite una extracción de forma segura del limpiaparabrisas evitando que se produzcan desperfectos en el brazo.

## EXTRACTOR DE BRAZO LIMPIAPARABRISAS

52454

0,2 6 36 576

11,00€



## EXTRACTOR DE JUNTAS HOMOCINÉTICAS

51364

2 5 280

26,00€



## EXTRACTOR ROSCADO PARA POLEA DE CIGÜEÑAL

51140

1,02 24 290

59,00€



- Diseñado para sostener la polea del árbol de levas inmóvil mientras que se afloja.
- Permite el ajuste del eje central cuando se acoplan, usando la barra atornillada centrada para desarrancar la polea.
- Tornillos de fijación: M6, M8.

## EXTRACTOR DE BUJES CON GRAPA ESPECIAL

51231

3,85 4 295

188,00€



x4



51138

3,95 4 296

188,00€



x5



- Incluyen arandelas cónicas de extracción PCD rango 96-126mm.
- Sirven para ser utilizados con herramientas neumáticas.

## KIT DE LIMPIEZA DE BUJES DE 14 PIEZAS

54069

0,24 10 40

28,00€



Elimina la suciedad superficial y la corrosión en los bujes equipados con espárragos.

- TPC Adaptador de 1/2" cuadrado de 8mm.
- TPC muela con eje de transmisión redondo de 8mm.
- 2PC almohadillas de gancho y bucle de repuesto con la parte posterior autoadhesiva.
- 5 discos de limpieza de grano grueso, con un diámetro exterior de 40 mm.
- 5 discos de limpieza de grano fino de 40 mm de diámetro exterior y 14 mm de diámetro interior.

## EXTRACTOR DE BUJES HIDRÁULICO

53638

13,35 1 28

236,00€



- Este kit incluye: 3 extractores / martillos: husillo hidráulico, tornillo y martillo de impacto, diseñados especialmente para simplificar la extracción del cubo de la rueda y liberar el eje del buje sin dañarlo.
- Para extracción manual o hidráulica.
- Con una capacidad máxima de 10 TON.
- Martillo de 4kg.
- Longitud de la barra: 57cm.
- Para 3, 4, 5, y 6 agujeros.

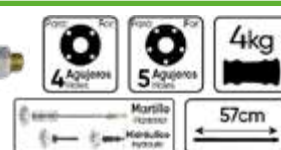

VAG (VW, AUDI, SEAT, SKODA),  
 PSA (CITROËN, CITROËN DS, PEUGEOT),  
 RENAULT, FORD, OPEL, BMW,  
 MERCEDES BENZ

HUSILLO  
 15253  
 57,00€

## EXTRACTOR DE BUJES CON MAZA DESLIZANTE

53635

6,50 2 84

69,00€



- Maza deslizante: 4 kg.
- Rango diámetro: 100-115mm.
- Para tornillos M12.
- Longitud: 457mm.

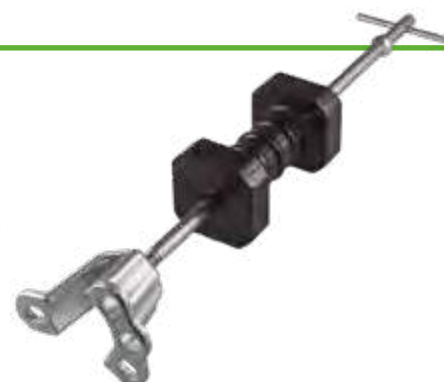
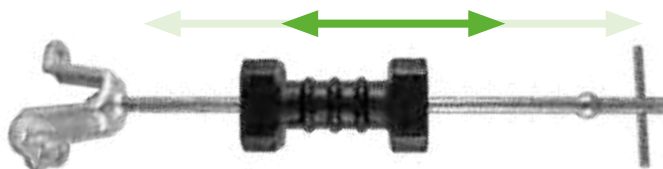

## DESMONTADOR DE TUBOS DE ESCAPE

51999

4,93 4 120

87,50€



- Apertura: Min. 50mm Max. 70mm
- Recorrido de enganche: 170mm.
- Contiene 4 adaptadores estriados.



## KIT EXPANSIÓN PARA SISTEMAS DE ESCAPE

52637

3,01 5 220

44,50€



1-1/8" - 1-3/4"  
1-1/2" - 2-1/2"  
2-1/8" - 3-1/2"

## INSTALADOR AJUSTABLE DE RETENES

53129

0,96 2 10 180

70,50€



18 - 90mm



## EXTRACTOR DE ABRAZADERAS HENN

53696

0,1 6 96

19,50€



- Volkswagen, Audi, Seat, Škoda, BMW, Peugeot, Citroën, Dacia, Fiat, Ford, Kia, Lexus, Mazda, Mercedes, Nissan, Opel/Vauxhall, Porsche, Renault, Toyota, Volvo.



## SET DE 2 GANCHOS PARA EXTRAER GOMAS EN TUBO DE ESCAPE

52849

0,22 10 40 480

7,50€

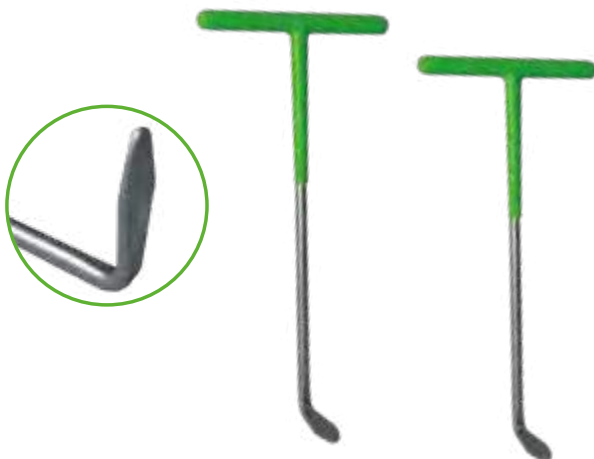

## SET DE 3 VASOS PENTAGONALES

51996

0,4 5 40 960

8,00€



19mm

14mm

10mm

ESCAPE



## LLAVE DINAMOMÉTRICA CON CABEZAL INTERCAMBIABLE 200NM

**52913**

292,00€

3,94

Kg

4

128

- Incluyen certificado de calibración de fábrica.

1/2"

- Rango de apriete: 40-200Nm.
- Cabezales incluidos: Llave plana 13, 14, 15, 17, 19, 22, 24, 27, 30mm.
- Cabezal de carraca 1/2".
- Cabezales diferentes disponibles por separado.

18x14mm



325mm

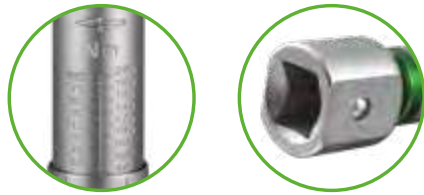

## LLAVE DINAMOMÉTRICA CON MIRILLA

**53081**  
115,00€

1,08  
5  
25  
200

1/4"

4-20NM (36T)

375mm

**53082**  
148,00€

1,85  
4  
8  
204

1/2"

40-210NM (24T)

560mm



## LLAVES DINAMOMÉTRICAS

- Incluyen certificado de calibración de fábrica.

**51262**

51,00€

0,83

Kg

4

16

384

1/4"

270mm

2-24 Nm  
0,2 - 2,4 M.Kg

**53972**

515,70€

8,75

Kg

2

3/4"

1000-1.210mm

200-800 Nm  
21,4 - 81,6 Kg

24

**51338**

52,50€

1,09

Kg

4

16

288

3/8"

365mm

19-110 Nm  
1,9 - 11 M. Kg

**51127**

55,50€

1,73

Kg

4

8

240

1/2"

470mm

28-210 Nm  
2,9 - 21,4 M. Kg



51262

53972

## SETS DE REPARACIÓN

**51262R**

9,90€

0,05 20

Para:

51262



**51338R**

9,90€

0,05 20

Para:

51338



**51127R**

9,90€

0,05 20

Para:

51127



## DESTORNILLADOR DINAMOMÉTRICO MECÁNICO

51830

76,50€



- Incluyen certificado de calibración de fábrica.

- Exactitud: CW: +/- 4%
- Rango de operación: 2-10 N-m
- Unidades de selección: N-m, in-lb.
- Largo (mm): 242
- Dado: 1/4"
- Vida útil: 10.000 ciclos



## GONIÓMETRO 3/4"

52793

37,00€



- Útil para el apriete en grados de tornillos según especificaciones determinadas por los fabricantes de vehículos y maquinaria.
- Apriete realizado mediante carraca o llave dinamométrica de 3/4".
- Mirilla transparente para una correcta visión de la medición.
- Rango de medición de 0 a 360°.
- Llave en forma de "L" para facilitar una fijación correcta de la herramienta para una posterior medición exacta.



## PROFUNDÍMETRO CON SOPORTE MAGNÉTICO

52904

55,50€



- Medición: 0-10mm.
- Calibrado: 0,01mm.
- Esfera: 58mm.
- Base magnética: 40kg.



PROFUNDÍMETRO PARA REF. 52904

13704

21,00€



## GONIÓMETRO 1/2"

52583

7,50€



## GONIÓMETRO DE 1/2" IMANTADO

52794

24,00€



- Útil para el apriete en grados de tornillos según especificaciones determinadas por los fabricantes de vehículos y maquinaria.
- Apriete realizado mediante carraca o llave dinamométrica de 1/2".
- Mirilla transparente para una correcta visión de la medición.
- Rango de medición de 0 a 360°.
- Fijación del goniómetro mediante brazo imantado para su correcta fijación antes de su uso. El sistema de imán permite utilizar la herramienta con rapidez de forma sencilla y segura.

## JUEGO DE GALGAS

52433

4,80€



0,05 - 1mm

## CALIBRE

50937

10,00€



MECÁNICO

150mm

50724

24,50€



DIGITAL

150mm

## PROFUNDÍMETRO DIGITAL

53042

9,90€



0-25.4mm



## PROFUNDÍMETRO

52873

9,50€

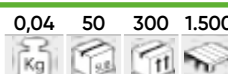

0-40mm



MEDICIÓN



## MULTIPLICADOR DE FUERZA ARTICULADO

52796

8,88

3

72

6.000Nm

85,20€

Kg

lit

lit

- Uso en camiones con tapacubos y protector de rueda.
- Evita el daño de la llanta.
- Único en el mercado.
- Fácil adaptación a cualquier vehículo universal.
- Útil para atornillar y desatornillar sin esfuerzo.

- Incluye:  
1x vaso 1" 32mm.  
1x vaso 1" 33mm.



1:58

## MULTIPLICADOR DE FUERZA JUNIOR

52012

2,34

4

128

PARA TURISMO

1/2"

66,50€

Kg

lit

lit



- Rango 1:18.
- Par max. salida: 360Nm.
- Par max. torsión: 800Nm.
- Contiene:  
1x multiplicador de par.  
1x barra de extensión 90°.  
Vasos de 17mm, 19mm y 21mm.

## MULTIPLICADOR DE FUERZA CON ALARGADOR

51919

7,86

3

120

72,00€

Kg

lit

lit

- Material: 40CR.
- Potencia máxima: 5800Nm.
- Potencia de trabajo: 3800Nm.
- Múltiple en rango 1:56.
- Incluye vasos de: 32mm y 33mm de 1".



## MULTIPLICADOR DE CARRACA 3/4" + REDUCTOR 1/2"

51958

4,35

4

96

340,00€

Kg

lit

lit



- Características:  
Relación de transmisión 1:4.  
Relación de par 1:3.3.  
Par máximo de entrada: 303Nm.  
Par máximo de salida 1000Nm.

- Contiene:  
1 Multiplicador de Par.  
1 Carraca manual.  
1 Adaptador 1/2" M x 3/4" F.  
1 Kit liberación.  
1 Barra de extensión 90°.  
1 Barra de extensión 350mm.

## SET MULTIPLICADOR DE FUERZA

52056

5,50

4

128

61,00€

Kg

lit

lit

1"

8 PCS

22, 24, 27, 30, 32, 33, 38, 41mm



### DESPIECE DISPONIBLE

REF.	DESCRIPCIÓN	Kg	lit	lit	€	REF.	DESCRIPCIÓN	Kg	lit	lit	€
10672	32mm	0,58	1		9,50€	10674	27mm	0,54	1		9,50€
10673	33mm	0,58	1		9,50€	10675	30mm	0,54	1		9,50€

## KIT CENTRADOR DE EMBRAGUE S.A.C.

53001

9,69 1 40

222,00€



- Se evitan deformaciones del embrague utilizando el pretensor.  
- Utilizando la Herramienta de Reseteado llevaremos a la nueva posición el anillo de reajuste de la placa de presión al montar una nueva válvula de embrague.  
- Adecuado para casi todos los embragues SAC (Embrague de Ajuste Automático).

- Ventajas:  
Tensado de la placa presión del embrague en el montaje y desmontaje.  
Reposición muelle de ajuste con la herramienta de reseteado.  
Centrado de la válvula con respecto al cojinete guía.

- Contenido:  
Pretensor de Embrague.  
Centrador de 3 agujeros.  
Herramienta de reseteado.  
Juego de espigas centradoras.  
Centrador de 4 agujeros.



PARA:  
VW  
Audi  
Bmw  
Mercedes  
Volvo  
Renault  
Opel

## RECAMBIO DE GAS

51986

0,18 24 1.584

9,80€



200ml

## SOPLETE DE GAS

51920

0,15 10 100 900

18,00€



- Gas no incluido.



## CENTRADOR DE EMBRAGUES S.A.C.

53410

1,6 5 230

79,50€



- Diámetro centradores:  
15-19 / 20-26,6 / 23-36mm

- Diámetro accesorios:  
12, 14, 15, 16, 17, 18, 19, 20mm



## JUEGO PARA LA REPARACIÓN DEL EMBRAGUE DE DOBLE CARA PARA LA TRANSMISIÓN DSG DE VAG

53057

6,04 2

134,00€



- Para servicio en cambios DSG en Golf (2004-), Golf Plus (2005-), AUDI A3 (2004-) con transmisiones de 7 velocidades código 0AM, y en Touareg (2003-) con transmisión de 6 velocidades código 08D.  
- Referencias OEM de los útiles: T10323, T10373, T10374.

## CENTRADOR DE EMBRAGUES S.A.C.

53392

0,6 25

47,50€



2 PCS

Ø 20 - 26mm



Ø 15 - 19mm



## CENTRADOR DE EMBRAGUES PLÁSTICO UNIVERSAL

52495

0,2 4 48 864

14,50€



- Para la mayoría de los modelos del mercado.  
- Incluye 3 adaptadores de diferentes diámetros.





# SET DE COMPROBACIÓN, LLENADO Y VACIADO DE SISTEMA AACC

**53456**

93,00€

2,8 5 75  
Kg u.s. tfl

BAR

- Permite probar las variaciones en los lados de alta y baja presión de los sistemas de aire acondicionado del vehículo.
- De peso ligero.
- Diseño de bloque de aluminio con vista de cristal y de fácil lectura de gran anti-vibración.
- Acopladores de servicio profesionales (codificados por colores y etiquetados).
- Tres mangueras de carga con código de colores y un gancho colgante para permitir el uso manos libres.
- Aplicaciones: R134a, R12.
- Longitud de la manguera: 1550mm.
- Alta presión: 0-34 BAR.
- Baja presión: 0-24 BAR.



ACOPLADOR PARA ALTA PRESION (REF.53456)

**14300**  
16,00€

0,20 100  
Kg u.s. tfl

ACOPLADOR PARA BAJA PRESION (REF.53456)

**14301**  
16,00€

0,20 100  
Kg u.s. tfl

## ADAPTADOR PARA CARGA DE GAS 1234YF

ALTA

**53499**

29,00€

0,2 15 60  
Kg u.s. tfl



BAJA

**53500**

29,00€

0,2 15 60  
Kg u.s. tfl



## LIMPIADOR DE AIRE ACONDICIONADO

**54077**

9,00€

0,40 24 1.152  
Kg u.s. tfl

CÁNULA FLEXIBLE PARA REF. 53824

**15314**  
3,15€

0,20 300  
Kg u.s. tfl



## ESTUCHE DE OBUSES PARA AACC

**53599**

28,00€

0,15 10 100  
Kg u.s. tfl

**134**  
PCS



R12 5mm L: 19mm	R12 6mm L: 19mm	R134A 7mm L: 20mm
R12 5mm L: 19mm	R12 6mm L: 22mm	R12 8mm L: 22mm
R12 5mm L: 19mm	R12 6mm L: 26.5mm	R12 9mm L: 22mm



### DESPIECE DISPONIBLE

REF.	MEDIDA		€/u.
14594	5x19mm R12 (verde)	0,01 10	2,00€
14595	5x19mm	0,01 10	1,50€
14596	5x19mm R12	0,01 10	2,00€
14597	6x19mm	0,01 10	7,60€
14598	6x26.5mm	0,01 10	17,80€
14599	7x20mm R134A	0,01 10	4,50€
14600	6x22mm	0,01 10	9,50€
14601	8x22mm	0,01 10	11,00€
14602	9x22mm	0,01 10	11,00€

## ESTUCHE DE JUNTAS TÓRICAS PARA AA/CC

**50807**

35,00€

0,16 5 50 750  
Kg u.s. tfl



5.29x1.78mm 20 PCS	6.07x1.78mm 20 PCS	6.8x1.9mm 20 PCS	7.65x1.78mm 20 PCS	7.80x1.90mm 20 PCS	8.0x2.0mm 20 PCS
8.80x1.90mm 20 PCS	10.82x1.78mm 15 PCS	10.77x2.62mm 15 PCS	11.0x2.0mm 15 PCS	12.0x2.0mm 15 PCS	13.9x1.80mm 10 PCS
13.95x2.62mm 10 PCS	14.0x2.0mm 10 PCS	15.0x2.0mm 10 PCS	17.0x2.00mm 10 PCS	17.17x1.78mm 10 PCS	17.04x3.53mm 10 PCS

**270**  
PCS

## KIT PARA LA DESCONEXIÓN DEL AIRE ACONDICIONADO

**53459**

64,00€

1,05  
10  
180  
Kg u.s. tfl



## KIT DE HERRAMIENTAS PARA AACC

**53457**

23,00€

0,35 10 20  
Kg u.s. tfl

CONTIENE

x1 1/4"

x7

TS10H,  
TS15H,  
TS20H,  
TS25H,  
TS27H,  
TS30H,  
TS40H,



## KIT DE DETECCIÓN DE FUGAS AA/CC

**53539** 1,35 5 165  
**68,00€** Kg fl



- Set especialmente diseñado para detectar fácilmente pérdidas de presión en el sistema de aire acondicionado y refrigeración.  
 - Consiste en insertar un líquido fluorescente neutro en el circuito para posteriormente detectar su fuga de forma rápida.

- Contiene:  
 1x Lámpara UV 100Lm.  
 1x Gafas visión UV.  
 1x Jeringa inserción líquido.  
 1x Adaptador rápido.  
 1x Alargador adaptador.  
 1x Pila recargable.  
 1x Cargador.



**100 Lm** **3W** **110V 220V** **x1 3.7V**

LÍQUIDO DETECCIÓN DE FUGAS SISTEMA AA/CC

**12977** 0,33 3 12 384  
**33,00€** Kg fl 250ml

- Una aplicación de 7,5 ml para cada 1,4L de refrigerante.



**GAFAS VISIÓN UV PARA 53539**  
**14187** 0,20 50  
**4,50€** Kg fl

**PILA RECARGABLE PARA 53539**  
**15052** 0,04 50  
**1,50€** Kg fl

**JERINGA DETECCIÓN FUGAS AA/CC REF. 52844/53539.**  
**12200** 1,10 50  
**12,00€** Kg fl

**LINTERNA PARA 53539**  
**15054** 0,12 50  
**28,50€** Kg fl

**CARGADOR PARA 53539**  
**15053** 0,04 50  
**8,50€** Kg fl

## LÁMPARA PORTÁTIL COB ULTRAVIOLETA FLEXIBLE CON BASE IMANTADA

**53530** 0,3 5 20 620  
**43,50€** Kg fl 380mm 45mm

**200 Lm** **LED** **5V** **3.7V 2.600MAh**  
**4H** **4H**

LUZ ULTRAVIOLETA

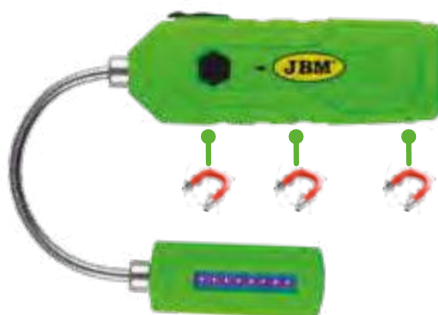

**UV**

## PROBADOR DE PRESIÓN SISTEMA REFRIGERACIÓN

**52687**  
**158,50€**

**5,72** Kg  
**1** fl  
**30**

- Rango de comprobación: 0-2,5 bar.  
 - 19 cabezales de comprobación de radiadores específicos.  
 - 1 cabezal de comprobación de radiadores universal.



**51339**  
**199,00€**

**5,24** Kg  
**3** fl  
**30**

- 0 -2,5 bar.  
 - Adaptador de 2.3".  
 - Adaptador de 4.5".  
 - Bomba de sistema de refrigeración.  
 - Junta en forma de T de 5/16" - 3/8".  
 - Manguera de aceite de 5/16" - 3/8".  
 - 2 Abrazaderas.



- Bomba de presión con válvula de descarga.
- conector 1: acople para los cabezales No.3(R123) y No.4 (R124).
- conector 2: acople para los cabezales No. 3 (R123) y No. 5(R125).
- Mercedes (W123, W126, W124, W201), GM(Buick), Jeep
- Peugeot, Subaru, Chrysler, Acura, GM (Nova, Spectrum, Sprint), Mitsubishi, Nissan, Mazda, Toyota, Infiniti, GEO, Suzuki, Isuzu, Mercedes.
- Honda, Toyota, Suzuki, Mitsubishi, Chrysler, Acura.
- Mercedes Benz (ML, W163, W164), GM (Achiva, Skylark, Grand Am 1992-2002).
- Volvo, Saab, Sterling, Citroen, Renault, Fiat, Alfa, Jeep.
- VW(Vento, T4, Passat-1996, Golf, Beetle, Sharan).

- Audi(A4, A5, A6), BMW 345, VW (Passat - 1997-2002), Porsche(Cayenne).
- BMW (E46, E36, E34, E39, E38, E32, E90).
- Audi, VW.
- Internacional, Land Rover, Jaguar.
- Mercedes (C, E, S, W140, W220, W124, W210, W211, W215, W216, W221, R230).
- Ford Focus.
- Mazda(M3).
- Mercedes clase A (W168).
- BMW E60, E63, E64, E65.
- VW SHARAN 1.8T 2.8.
- TOYOTA-RAV4, PREVIA Adaptador universal de goma para purga y llenado de radiadores.
- SAAB.
- LAND ROVER.

- GM, 4 cilindros (Buik, Chevrolet, Pontiac, Cadillac).
- Camión.
- Mercedes-Benz, Ford, Chrysler, GM, Jeep, Peugeot.
- Acura, Dodge, Eagle, Geo, Honda, Isuzu, Lexus, Mazda, Mitsubishi, Suzuki, Toyota, Nissan, GM, Peugeot, Ford, Chrysler.
- Toyota, Honda, Mitsubishi, Suzuki, Lexus, Chrysler, Acura, Dodge.
- Buick, Chevrolet, Ford, Lincold, GM, Opel, VW, Saab, Benz (clase ML) Jaguar,

- Rover.
- Jeep, Renault, Saab, Volvo, Audi, Citroen, Fiat, Peugeot, Alfa.
- VW.
- Audi (A4,A6, A8) VW (Passat 1997-2002, Golf, Jetta).
- BMW.
- VW, Audi.
- Ford, GM, Rover, Opel, Jaguar, BMW 245.
- Mercedes-Benz Sedane.
- Saab, Opel.



## SET DE LLENADO DE ACEITE CON EMBUDO Y ADAPTADORES

**53485**

**139,50€**



**15**  
PCS

- Subaru (M42x4,5).
- Lexus, Pontiac, Scion, Toyota (M37x3,0).
- Ford, Jaguar, Land Rover, Mazda (M35x4,0).
- Acura, Dodge, Ford, Honda, Jaguar, Jeep, Land Rover, Mazda, Nissan, Acura (M32x3,5).
- Audi, BMW, Mercedes, Porsche, Volvo, VW.
- Toyota, Lexus, Scion, Pontiac.
- Dodge (M30x3,0).
- Mazda (1/2" Turn).
- Cadillac, Chevy, Ford, GMC, Hyundai, Jaguar, Land Rover, Mazda, Mercury, Saab (1/2" Turn).
- Audi, VW, Skoda (1/4" Turn).
- Dodge (1/2" Turn).
- Lexus, Pontiac, Scion, Toyota (M37x3,0).



**53347**

**99,00€**



**8**  
PCS

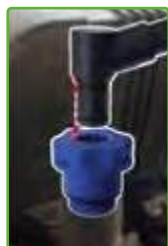

## BOMBA DE COMPROBACIÓN, PRESIÓN Y VACÍO PARA CIRCUITOS

**54016**

**71,00€**



**MAX**  
40 PSI  
3 bar

**MIN**  
-20 PSI  
-0,75 bar

Este kit incluye, junto a la bomba de vacío, un set completo de puntas, adaptadores, tapones, gomas y medidor para un correcto y fácil sangrado del sistema de frenos, así como una fácil comprobación.

Presión máxima: 40psi (3 bar)  
Presión mínima: -20 psi (-0,75 bar)



SISTEMA DE REFRIGERACIÓN

## COMPROBADOR DE FUGAS PARA JUNTAS DE CULATA

**53662**

**82,00€**



**80**

- Esta herramienta está diseñada para comprobar las fugas entre la combustión y el sistema de refrigerado de los motores refrigerados por agua.
- El proceso de combustión produce (entre otros gases) 13-14% de CO2 en el escape, y las fugas de este gas en el sistema de refrigerado son fácilmente detectables.
- Si hay gases de combustión, el color del fluido de comprobación cambiará a color amarillo o verde y eso será prueba de la fuga de CO2 en el refrigerante.
- El fluido de comprobación se puede volver a usar. (dirijase a las instrucciones).

- Contiene:  
Botella redonda 200ml.  
Botella cuadrada 250ml.  
Adaptadores:  
Pequeño: Toyota, Mitsubishi.  
Mediano: Suzuki, Toyota, Mitsubishi, Subaru, Peugeot, Nissan, Lexus, Mazda.  
Grande: Ford, GM, Benz, JEEP.



LÍQUIDO DE COMPROBACIÓN DE FUGAS EN LA COMBUSTIÓN

**14563**  
**18,00€**



## SET DE 6 VASOS 1/2" TORX TIPO E EXTRA LARGOS

53915

2 10  
Kg fl

57,50€

### E12 Llave de vaso para culata de BMW:

- Motor M42, 1.8L, 4 cilindros, 16V, modelo 318 is desde 1989
- Motor M50, 2.0L, 2.5L, 6 cilindros, 24V, modelo 520i, 525i desde 1991

### CONTIENE

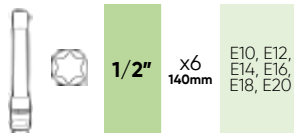

6  
PCS

1/2"

CrV

CINCADO

## KIT COMPRESOR MUELLE PARA VÁLVULAS

51120

2,42 5 160  
Kg fl

39,80€



- Válido para coches y motocicletas.
- Los 5 adaptadores permiten encajar correcto y fácilmente para comprimir el muelle de la válvula.

- Contenido:  
Compresor de Muelles.  
Adaptadores de: 30, 25, 23, 19, 16mm.

## COMPRESOR MUELLE DE VÁLVULAS 45-145MM

52734

2,61 5 175  
Kg fl

43,50€

45-145mm

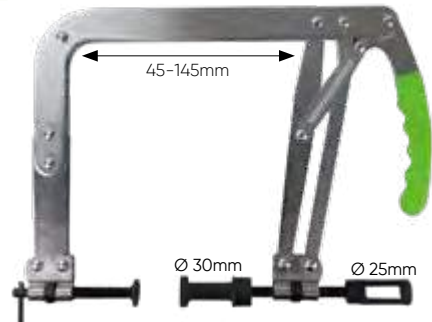

## ORGANIZADOR DE PIEZAS DE CULATA

53637

1,40 5 20  
Kg fl

84,50€

260mm 400mm 450mm



- Especial para piezas de culata.
- Mantiene todos los componentes limpios y ordenados a medida que se extraen de la culata.
- Ahorra tiempo. Te facilita el trabajo.

## COMPRESOR MUELLE PARA VÁLVULAS

52693

0,82 5 20 450  
Kg fl

24,50€



- Uso para la mayoría de motores OHV, OHC, CHV.
- Permite reemplazar muelles y sellos de válvulas con la cabeza del cilindro montada.

- Capacidad para comprimir y extraer.

- Con garra / adaptador reversible y bloqueo de posición predeterminada.



## HERRAMIENTA NEUMÁTICA PARA ESMERILAR VÁLVULAS - PERCUSIÓN Y ROTACIÓN

53572

1,90 5 80  
Kg fl

275,00€

- Contenido :  
1 x Máquina neumática para válvulas.  
5 x Adaptador de válvula.  
1 x 3 mm Llave Allen.  
5 x Ventosa (16, 20, 30, 35 y 45 mm).



REGULA LA VELOCIDAD



14157  
7,50€

14158  
5,00€

14159  
11,00€

14160  
6,50€

14161  
12,00€



GIRO DERECHO + GIRO IZQUIERDO

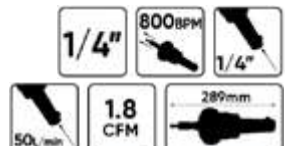

## KIT COMPRESOR DE MUELLE AMORTIGUADORES

51121

1,72 5 416  
Kg fl

26,00€

- Garra y Espárragos forjados con aleación Hierro - Carbono (termo - tratados).
- Indicada para usar en espacios limitados y bajo el arco de rueda.
- Apertura máxima: 250mm.

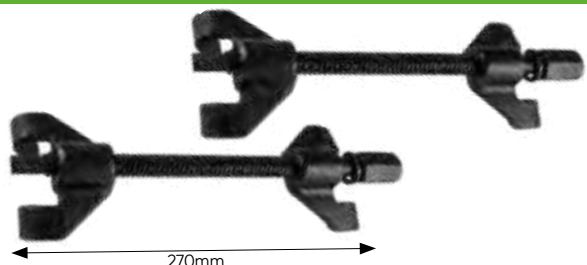

270mm



## COMPRESOR PARA AMORTIGUADORES 1T

53742

66,50 1 6

999,00€



- Capacidad: 1000kg
- Longitud máxima de trabajo: 450mm
- Longitud de carrera del cilindro: 420mm
- Diámetro del muelle: Ø102-165mm
- Sentido de rotación: Horario
- Presión de aire máxima: 6.5 - 8 bar (94.27-130.53 psi / 0.65-0.9 MPa)
- Modo de funcionamiento: Pedal de pie



1410mm 690mm 560mm

1T



ALIMENTACIÓN NEUMÁTICA



## COMPRESOR DE MUELLES

53394

297 1 18

584,50€



26.000 Nm  
1.050 Kg

- Kit profesional que permite extraer e instalar de manera rápida los muelles de suspensión delantera y trasera sin desmontar el eje.
- Brazo telescópico y superficies antideslizante que permite un agarre sólido de los muelles.
- Garras equipadas con una protección plástica intercambiable para evitar dañar la pintura del muelle.
- Evita que se doblen los muelles en la compresión.
- Universal, cubre el 90% del parque de vehículos.
- Puede ser utilizado tanto para muelles rectos como cónicos.

- Contenido:  
Dispositivo/pistón.  
Tres pares de mordazas con fundas de plástico.



Apta para utilizarse con herramientas neumáticas

## KIT PARA DESMONTAR AMORTIGUADORES

53118

6,66 2 42

204,50€



39  
PCS

CRV 6140  
CRMO  
SCM415  
CRV 50BV30



## COMPRESOR DE MUELLES PARA AMORTIGUADORES

50827

32,45 1 18

387,00€



1T

- Capacidad: 1T (2200 lbs)
- Diámetro del muelle comprimido: 200mm
- Rango de compresión: 200-500mm

830mm

350mm

190mm

200-500mm



COMPRESORES

## COMPRESOR DE MUELLES PROFESIONAL McPHERSON

52227

198,00€

15,1

Kg

1

fl

24

fl

- BMW, Toyota, Ford, Mitsubishi, VW, Audi, Saab, Nissan, Honda Accord, Subaru, Volvo, Opel, Porsche.



- Especificaciones:  
Carga máxima: 2500N.  
Un cuerpo principal.  
Un soporte extendido.  
3 pares de mandíbulas.

- Par 1: Rango de uso: 80-115mm, Peso: 1.45kg.  
- Par 2: Rango de uso: 110-195mm, Peso: 2.2kg.  
- Par 3: Rango de uso: 140-195mm, Peso: 2.3kg.

NO USAR CON PISTOLA NEUMÁTICA

## COMPROBADOR ANGULAR DE CAÍDA IMANTADO

52318

64,50€

0,64

Kg

6

fl

24

fl

336

fl

-6°/+6°



## ALINEADOR DE CAIDAS (VAG)

53488

56,50€

2,75

Kg

5

fl

200

fl

22mm



Ancho de presión:  
135-175mm

- Permite que una sola persona ajuste del ángulo de caída de la rueda.

- Incluye:  
husillo hexagonal de 22mm  
3 longitudes distintas para:  
- 75mm: Seat - Toledo | VW-Jeta/Golf.  
- 85mm: Seat - Cordoba | VW-Polo/95>.  
- 115mm: Chrysler - Voyager.



## CORTADOR DE CADENAS DE MOTOCICLETA

53665

15,50€

0,35

Kg

10

fl

60

fl

25-60



53666

22,00€

0,70

Kg

5

fl

30

fl

60-100



53665



53666

## DESMONTADOR Y REMACHADOR DE CADENAS DE MOTOCICLETA

53055

30,50€

0,89

Kg

10

fl

600

fl



## LIMPIADOR BORNES BATERÍA

52319

8,20€

0,16

Kg

12

fl

48

fl

720

fl

52621

11,00€

0,14

Kg

10

fl

40

fl

800

fl



x2

## ASA PORTABATERÍA

52613

21,00€

0,57

Kg

6

fl

18

fl

360

fl



110-190mm

## KIT DE LIMPIEZA DE ASIENTOS DE INYECTORES

53650

48,00€

0,90

Kg

5

fl

180

fl

- Kit con tres cepillos de acero revestido de latón para limpiar los restos de carbonilla restantes de las paredes laterales del ASIENTO DE INYECTORES así como dos cepillos de nailon de silicona para limpiar la base DEL ASIENTO.  
- Los cepillos de limpieza pueden conectarse rápidamente a la extensión flexible proporcionada.  
- Este kit también contiene seis tapones de sellado y una varilla de inserción para evitar que los restos de carbonilla penetren accidentalmente dentro de la cámara de combustión durante el proceso, además de un cepillo de alambre de acero de pequeño calibre para limpiar la parte inferior DEL ASIENTO.

- Contiene:  
3 cepillos de latón.  
2 cepillos de silicona-nylon.  
1 extensor.  
6 tapones de cierre para el sellado de la cámara de combustión.  
1 varilla para la inserción de los tapones de cierre.  
1 cepillo de alambre de acero para la limpieza de la culata.



SET DE 3 CEPILLOS DE LATÓN PARA 53650

14348

12,50€

0,05

Kg

50

fl



SET DE 2 CEPILLOS DE SILICONA PARA 53650

14349

20,50€

0,07

Kg

50

fl



## KIT DE HERRAMIENTAS PARA AROS DE PISTÓN

**53251**

88,00€

Kg 2,80  
ft<sup>3</sup> 4  
ft<sup>2</sup> 72



- Juego completo ceñidor de aros y anillos de pistón.
- Tenaza o alicata para instalar segmentos de pistones.
- El apriete de los ceñidores tiene sistema de carraca dentada.

**H:3"**  
Ø 53-125mm

**H:4"**  
Ø 60-175mm

**H:6"**  
Ø 60-175mm

## COMPRESOR AROS PISTÓN

**52697**

12,50€

0,55 5 40 480  
Kg u.s. ft<sup>3</sup> ft<sup>2</sup>

6"

Ø 60-175mm

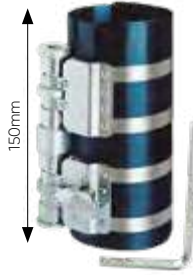

52697

**52696**

8,00€

0,29 5 40 1.280  
Kg u.s. ft<sup>3</sup> ft<sup>2</sup>

3"

Ø 53-175mm



52696

## ESTUCHE 38 CEPILLOS METÁLICOS/PLÁSTICOS

**51989**

46,00€

1,64 10 120  
Kg u.s. ft<sup>3</sup> ft<sup>2</sup>



- 1 Mango de 1/4".
- 1 Alargador.
- 36 cepillos.

Ø 8, 9, 10, 11, 12, 13, 14,  
15, 16, 17, 18, 19mm

**38**  
PCS



## LLAVE PARA TAPA DE AFORADORES

**53096**

26,50€

89-170mm

15mm



Kg 1  
ft<sup>3</sup> 5  
ft<sup>2</sup> 10  
ft<sup>2</sup> 320



## CEPILLOS METÁLICOS

**52760**

4,10€

0,09 12 120 2.160  
Kg u.s. ft<sup>3</sup> ft<sup>2</sup>

**52515**

9,10€

0,15 6 72 800  
Kg u.s. ft<sup>3</sup> ft<sup>2</sup>

225mm

**3**  
PCS



- 1 x latón.
- 1 x nylon.
- 1 x acero.

## EXTRACTOR UNIVERSAL DE AFORADORES

**52757**

16,00€

0,55 5 20 360  
Kg u.s. ft<sup>3</sup> ft<sup>2</sup>



160mm  
75mm



## LLAVE DE VASO ESPECIAL MOTOCICLETAS

**53054**

4,00€

0,16 12 72 1.500  
Kg u.s. ft<sup>3</sup> ft<sup>2</sup>

19, 22, 24mm



## LLAVE PARA MOTOCICLETA

**53086**

9,00€

0,19 12 72 1.500  
Kg u.s. ft<sup>3</sup> ft<sup>2</sup>

17, 19, 22, 24mm

**3/8"**



Yamaha, Kawasaki,  
BMW, Suzuki, Honda

## BRUÑIDOR DE CILINDROS

### 2 BRAZOS

**52591**  
12,00€

0,1 Kg

50 100 200

∅ ↑ 55mm  
↓ 19mm

28,6mm

1-1/8"



### 3 BRAZOS

**52592**  
19,00€

0,14 Kg

5 20 480

∅ ↑ 85mm  
↓ 35mm

50,8mm

2"

**52593**  
31,30€

0,47 Kg

6 36 320

∅ ↑ 170mm  
↓ 55mm

101,6mm

4"



**PASTILLA PULIDO 1-1/8"**  
EN BLISTER DE 2 UNIDADES  
PARA REF. 52591

**11878** 0,02 50  
4,10€

**PASTILLA PULIDO 2"**  
EN BLISTER DE 3 UNIDADES  
PARA REF. 52592

**11879** 0,04 60  
5,10€

**PASTILLA PULIDO 4"**  
EN BLISTER DE 3 UNIDADES  
PARA REF. 52593

**11880** 0,04 25 100  
10,50€



## PISTOLA ESTROBOSCÓPICA

### DIGITAL

**53474**  
78,00€

0,85 Kg

20 160

12V 3,6W

1,8m

0,1°

9.000



- Permite ajustar el encendido en los motores.

**53240**  
58,00€

0,75 Kg

5 20 160

12V 3,6W

1,5m



2 PINZAS

SENSOR INDUCTIVO

2 PINZAS

SENSOR INDUCTIVO

## ESTETOSCOPIO ELECTRÓNICO

**53249**  
175,00€

2,85 Kg

5 50



- Kit adecuado para detección de fallos en colectores de admisión / escape, inyectores, radiadores, etc.
- Permite la auscultación de varios puntos del vehículo de forma simultánea facilitando la tarea del operario a la hora de encontrar y diagnosticar averías.
- Sondas marcadas por color que facilitan la tarea al operario.
- Utilizado por ruido, dureza y vibración de motores para aislar las causas del problema.
- Características:  
Longitud del cable del sensor: 4,8 m.  
Longitud de la sonda de audio: 14 cm.  
Baterías de 9V (incluida).  
Cantidad de sensores: 6.  
Adecuado para conector de 3,5 mm.  
Longitud ajustable del micrófono: 21cm.

- Incluye:  
Probadores de audio, cascos, 6 clips de micrófono i 6 canales de micrófono de caja.  
Funciona con pilas cuadradas (incluidas).  
Velcro de sujeción para los sensores.

## ESTETOSCOPIO

**51347**  
9,00€

0,15 Kg

5 50 300

910mm

320mm

∅ 12mm



- Permite escuchar los problemas de localización racional de los flujos de agua, gas, vapor o petróleo.
- Amplifica y localiza ruidos internos mecánicos y de paso de fluidos.
- Localiza la fuente de ruido del motor rápidamente.

## ÚTIL PARA EXTRACCIÓN DE CONECTORES VAG

**53663**  
6,50€

0,01 Kg

10 100

VAG



- Herramienta para desmontar conectores en vehículos del grupo VAG sin dañarlos.



## SET DE PUNTAS PARA AJUSTE DE FAROS DE FAROS

53729

18,00€

0,40 10 40

Kg us fl



## LLAVE PARA MANIJA DE PUERTAS VAG

53655

11,50€

0,09 12 96

Kg us fl



## PORTAPUNTAS ANGULAR

52620

8,00€

0,05 6 36 1.584

Kg us fl

37mm



- Para zonas de difícil acceso.
- Con función de enchufe rápido.
- Fácil de extraer.
- Broca de 6mm.

## ÚTIL DE BLOQUEO PARA RESORTE DE GAS

53525

11,00€

0,08 5 30 300

Kg us fl

- Diámetro de apertura máximo: 10mm.



## JUEGO DE 8 PINZAS PARA LA DESCONEXIÓN DE MANGUERAS

53477

34,50€

0,8 10 220

Kg fl

8 PCS

NYLON

8, 10, 13mm

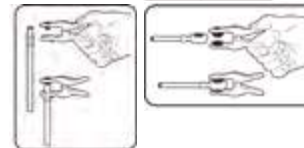

## BARRA EXTENSIBLE MULTIFUNCIÓN

52497

18,00€

0,29 6 48 480

Kg us fl

↑120mm  
↓53mm

53196

21,00€

0,3 6 48 576

Kg us fl

↑160mm  
↓71mm

CON 3 SECCIONES DE ALUMINIO

FUERTE Y LIGERA

- Para comprobar el funcionamiento correcto de las luces de freno: extendiendo la barra, un extremo presionando el pedal del freno y el otro el volante.

- Para determinar la presión de los neumáticos, eliminar pequeñas piedras o clavos en las ranuras de los neumáticos, levantar el capó superior convenientemente y comprobar el aceite del motor, batería, correa, radiador, etc.



## JUEGO DE TRES PINZAS PARA MANGUERAS FLEXIBLES

52066

12,00€

0,28 5 40 450

Kg us fl

NYLON

3 PCS

1/2" 3/4" 5/8"

- Adecuado para el circuito de frenos, gasolina y refrigerante.
- Fabricadas en material ligero y aisladas eléctricamente.

0-20mm

0-35mm

0-70mm



53395

16,00€

∅ 10, 15, 24mm

Kg 0,3

5

40

360



## SET DE 3 BANDEJAS DE HERRAMIENTAS FLEXIBLES ANTIDESLIZANTES

**53903**

1,43 10

59,00€



- Antideslizante.
- Ideal para mantener las herramientas al alcance.
- Fácil de transportar.
- Resistente al aceite.
- Soporta temperaturas de hasta 140°C
- Regla integrada a ambos lados de la bandeja.

- Compartimentos separados para mantener las herramientas bien organizadas.
- Disco de succión único para un mayor agarre en superficies planas.

- Pequeña: 285x137x27mm
- Mediana: 285x202x27mm
- Grande: 543x300x27mm
- Material: goma blanda.

### BANDEJA PEQUEÑA

**15010**

0,31 20

16,50€



### BANDEJA MEDIANA

**15011**

0,31 20

18,00€



### BANDEJA GRANDE

**15012**

0,82 10

31,50€



## BANDEJA FLEXIBLE MAGNÉTICA

- Bandeja de plástico con solapa magnética para sujetar tornillos, pernos y piezas pequeñas.

**52516**

25,50€

0,42 6 24 1.152



- Ø superior: 225mm.
- Ø base: 88mm.
- Medidas desplegado: 135mm.
- Medidas plegado: 43mm.

**52517**

5,50€

5,02 12 72 1.152



- Ø superior: 135mm.
- Ø base: 53mm.
- Medidas desplegado: 90mm.
- Medidas plegado: 31mm.



## RECIPIENTE MAGNÉTICO

**52466**

11,00€

0,43 1 20 180



Ø 150mm

112mm

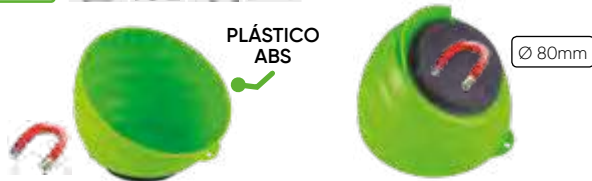

PLÁSTICO ABS

Ø 80mm

## BANDEJA IMANTADA

**50787**

8,00€

0,31 36 648



x1 Ø 150mm



**50788**

14,50€

0,62 24 432



x1 239 x 139mm



## COLGADOR MAGNÉTICO

**52467**

10,00€

0,5 24 1.008



40mm 145mm 75mm

- Imán de gran alcance.
- Acolchado para evitar dañar superficies.



## BANDEJA IMANTADA PARA HERRAMIENTA NEUMÁTICA

**52378**

9,50€

0,36 10 40 720



3KG Ø 60mm



**51341**

35,00€

1,62 12 96



9KG Ø 70mm

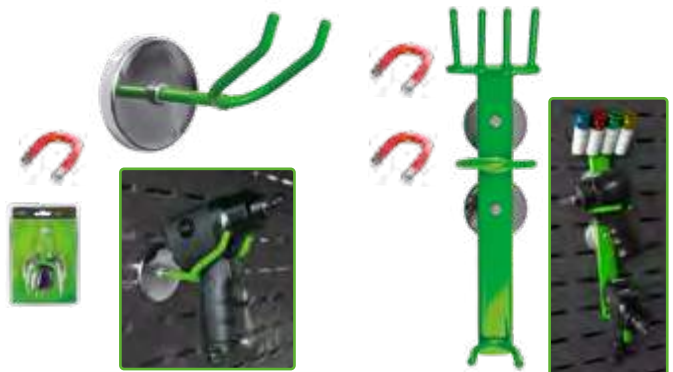

## SET 2 ESTANTES IMANTADOS

**50790**

29,00€

1,17 12 96



21x11,5cm

28x11,5cm

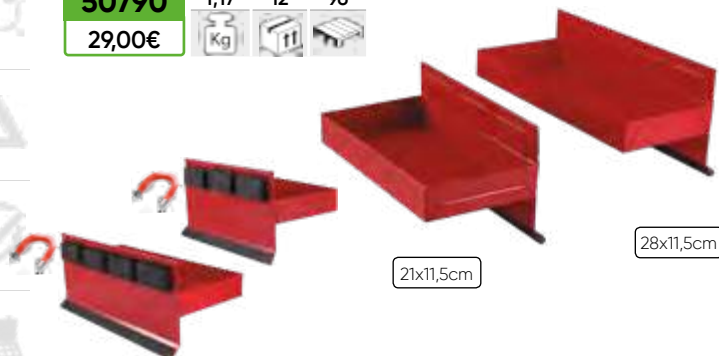

## SET DE 5 IMANES

**53958**

4,50€

0,05 10 100



5 PCS

NEODIMIO

Ø 15mm



## BARRA MAGNÉTICA PARA HERRAMIENTAS

**50789**

29,00€

0,89 10 20 300



600mm





BMW



220

MERCEDES



223

VAG



224

RENAULT / NISSAN



229

FORD / MAZDA



231

JAGUAR / LAND ROVER



232

OPEL / VAUXHALL



232

CITROËN / PEUGEOT



236

VARIOS



241

CARROS DE HERRAMIENTAS CON  
KITS DE CALADO



240



# KITS DE CALADO (TIMING TOOLS)



ref. 53951/53952

## KIT DE CALADO BMW N42/N46 1.8 / 2.0 CADENA

53259

2,8 5 135

gasolina

97,00€

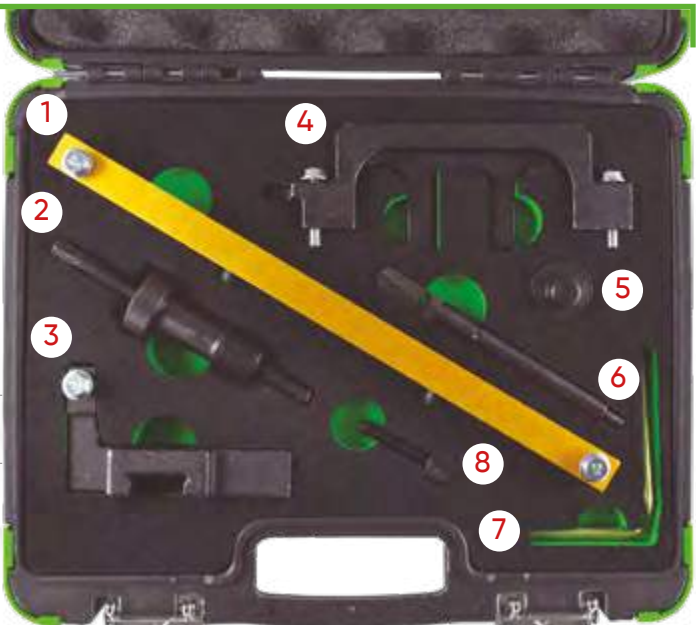

MARCAS	BMW	BMW 1 SERIES: 118i E81/82/87/88 (04-14), 120i E81/82/87/88 (04-14). BMW 3 SERIES: 316i/ti Compact E46 (01-07), 318i/ti Compact E46 (01-07), 318i E90/91/92/93 (05-12), 320i E90/91/92/93 (05-12). BMW 5 SERIES: 520i E60/61 (07-10), Z4 2.0 E85/86 (04-09). BMW X SERIES: X1 sDrive 18i E84 (10-12), X1 xDrive 18i E84 (10-12), X3 2.0 E83 (05-10).
HERRAMIENTAS OEM	11.9.350 (1), 11.9.340 (2), 11.9.291 (3), 11.9.292 (4), 11.9.270 (5), 11.5.120 (6), 11.9.190 (7), 11.9.293 (8)	
CÓDIGOS DE MOTOR	1.8: N42; B18A, N46; B18. / 2.0: N42; B20A, N46; B20, B20B, N46T; B20, B20B, B20BD, B20BZ, B20O2, B2O2.	

## KIT DE CALADO BMW N43 1.6 / 2.0 CADENA

53260

5,6 2 40

gasolina

230,50€

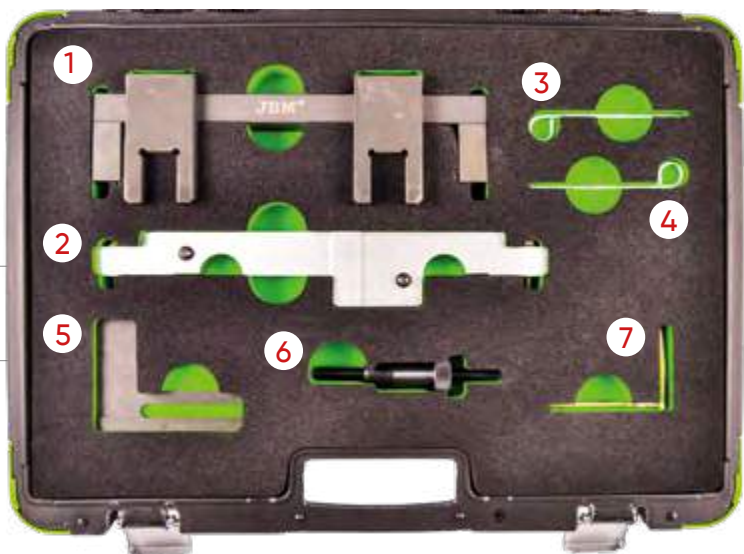

MARCAS	BMW	BMW 1 SERIES: 116i E81/82/87/88 (07-12), 118i E81/82/87/88 (06-14), 120i E81/82/87/88 (06-14). BMW 3 SERIES: 316i E90/91/92/93 (07-11), 318i E90/91/92/93 (07-13), 320i E90/91/92/93 (07-14). BMW 5 SERIES: 520i E60/61 (07-10).
HERRAMIENTAS OEM	11 8 690 (11 8 691/11 8 692/11 8 693) (1), 11 8 710 (11 8 711/11 8 712) (2), 11 3 340 (3) (4), 11 8 700 (5), 11 9 340 (11 9 341/11 9 342) (6), 11 5 120 (7).	
CÓDIGOS DE MOTOR	1.6: N43 B16A/AA, B16AA, B16AA/OO. 2.0: N43 B20A, B20A/AA, B20AA, B20AY, B20KO, B20UO.	

## KIT DE CALADO BMW N42 / N46 2.0

53261

5,2 2 40

gasolina

201,50€

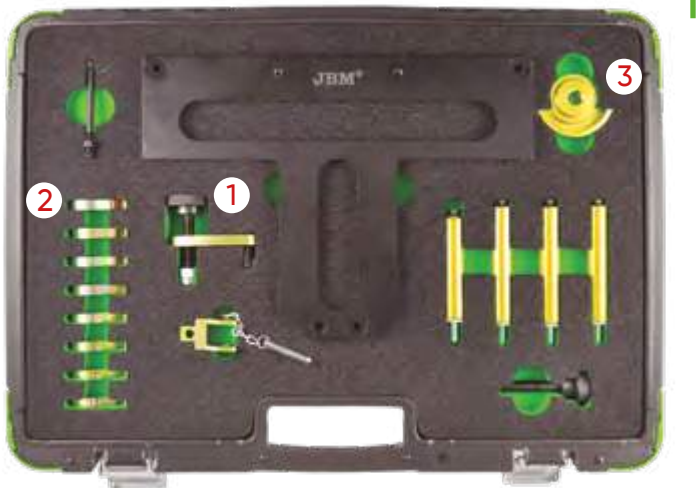

MARCAS	BMW	BMW 1 SERIES: 118i E81/82/87/88 (04-14), 120i E81/82/87/88 (04-14). BMW 3 SERIES: 316i/ti Compact E46 (01-07), 318i/ti Compact E46 (01-07), 318i E90/91/92/93 (05-12), 320i (E90/91/92/93 (05-14). BMW 5 SERIES: 520i E60/61 (07-10). BMW X SERIES: X1 E84 sDrive 18i (10-12), X1 E84 xDrive 18i (10-12), X3 E83 2.0 (05-10). BMW Z SERIES: Z4 2.0 E85/86 (04-09).
HERRAMIENTAS OEM	11 9 190 (1), 11 9 310 (2), 11 9 302 (3)	
CÓDIGOS DE MOTOR	2.0: N42 B18A, N42 B20A, N46 B18, N46 B20, N46 B20B, N46T B20, N46T B20B, N46T B20BD, N46T B20BZ, N46T B20O2, N46T B2O2	



## KIT DE CALADO ÁRBOL DEL LEVAS BMW M52TU/M54/M56 DOBLE VANOS

53262

5,6 2 40

gasolina

233,00€

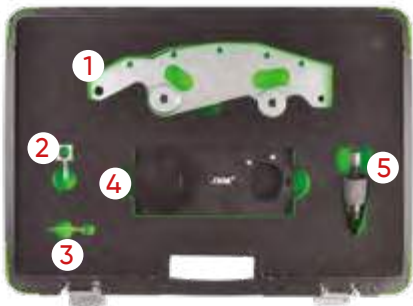

MARCAS

BMW

M52TUB25: 1997-2001 E46 323i/323Ci/323ti (M52T); 1998-2001 E39 523i (M52TU); 1998-2001 E36/7 Z3 (M52TU).  
M52TUB28: 1997-2001 E46 328i/328Ci (M52TU); 1997-2001 E36/7 Z3 2.8 (M52B28/Z3); 1998-2001 E39 528i (M52TU); 1998-2001 E38 728i (M52TU).  
M54B22: 2001-2003 E46 320i/320Ci; 2001-2003 E39 520i; 2001-2002 E36 Z3 2.2i; 2003-2005 E85 Z4 2.2i; 2003-2005 E60/E61 520i.  
M54B25: 2001-2002 E36/7 Z3 2.5i; 2001-2005 E46 325i/325xi; 2001-2006 E46 325Ci; 2001-2004 E46 325ti; 2001-2004 E39 525i; 2003-2004 E60/E61 525i/525xi; 2004-2006 E83 X3 2.5i; 2004-2006 E85 Z4 2.5i.  
M54B30: 2001-2005 E46 330i/330xi; 2001-2006 E46 330Ci; 2001-2003 E39 530i/2001-2002 E36 Z3 3.0i; 2003-2005 BMW E60 530i; 2003-2006 E85 Z4 3.0i; 2001-2006 E53 X5 3.0i.

HERRAMIENTAS  
OEM

116150 (1), 113450 (2), 113292 (3), 116180 (4), 114220(5)

## KIT BLOQUEO ARBOL DE LEVAS BMW M47

53263

1,8 5 165

diesel

56,50€

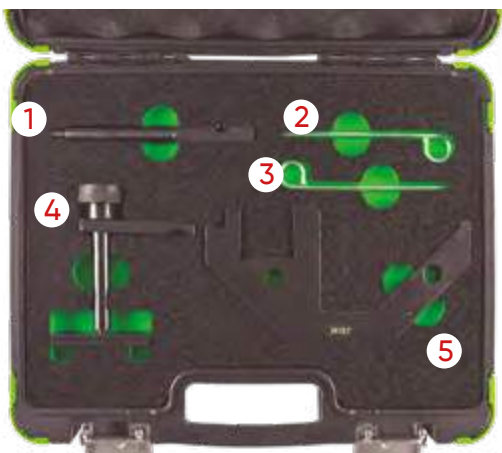

MARCAS

BMW

BMW 1 SERIES: 118d E87 (04-07), 120d E87 (04-07).  
BMW 3 SERIES: 318d/td Compact E46 (01-05), 318d/td E90/91 (05-08), 320d/td Compact E46 (98-05), 320d/cd E90/91 (05-08), 325d E90/91/92/93 (02-10), 330d/cd E46/90/91/92/93 (99-07), 335d E90/91/92 (06-11).  
BMW 5 SERIES: 520d E39/60/61 (00-09), 525d/xd E39/60/61 (00-10), 530d/xd E46/60/61 (98-10), 535d E60/61 (04-10).  
BMW 6 SERIES: 635d E63/64 (07-11).  
BMW 7 SERIES: 730d/ld E38/65/66 (98-08).  
BMW X SERIES: X3 2.0d E83 (04-07), X3 3.0d/sd E83 (03-10), X5 3.0d E53/E70 (00-10), X6 3.0d E71/72 (08-10), X6 3.5d E71/72 (08-10).  
LAND ROVER: Freelander Td4 (00-06), Range Rover Td6 (02-06).  
MG/ROVER: MG-ZT/T (01-05), Rover 75 CDT/CDTi (99-05).  
VAUXHALL/OPEL: Omega-B (01-03).

HERRAMIENTAS  
OEM

11.2.300/12-108, 12-171/KM-813 (1), 11.3.340/12-172/KM-823 (2) (3), 11.6.322/12-174/KM-6267 (4) 11.6.320 (5)

CÓDIGOS DE  
MOTOR

BMW  
2.0D: M47, M47T2, M47TU / 2.5D: M57, M57T2, M57TU / 3.0D: M57, M57T2, M57TU  
LAND ROVER  
2.0D: 204D3 (TD4) / 3.0D: 306D1 (TD6)  
MG/ROVER  
2.0D: M47R / 2.0d CDT: M47R  
VAUXHALL/OPEL  
2.5D: Y25DT

## KIT DE CALADO BMW N62/N73

53264

4,65 2 40

gasolina

141,50€



MARCAS

BMW

BMW 5 SERIES: 540i E60/61 (05-10), 545i E60/61 (03-06), 550i E60/61 (05-10).  
BMW 6 SERIES: 645i E63/64 (03-06), 650i E63/64 (05-11).  
BMW 7 SERIES: 735i E65/66 (02-05), 740i E65/66 (05-10), 745i E65/66 (02-05), 750i E65/66 (05-08), 760i E65/66 (02-08).  
BMW X SERIES: X5 4.4 E53 (03-07), X5 4.8 E53/E70 (04-10).

HERRAMIENTAS  
OEM

119463 (1), 119462 (2), 119340 (3), 119461 (4), 119190 (5)

CÓDIGOS DE  
MOTOR

3.6 V8: N62 B36A 4.4 V8: N62 B44A 6.0 V12: N73 B60A  
4.0 V8: N62 B40A 4.8 V8: N62 B48B

## KIT DE CALADO BMW DIESEL

53265

5,45 2 40

diesel

185,50€



MARCAS

BMW

HERRAMIENTAS  
OEM

113360 (1), 116321 (2), 135190 (3), 135191 (4), 135192 (5), 116322 (6), 112300 (7), 113340 (8)

CÓDIGOS DE  
MOTOR

Diesel Engines M41 / M51 / M47TU / M47TU T2. M57TU T2 3.01 1998 - 2008.

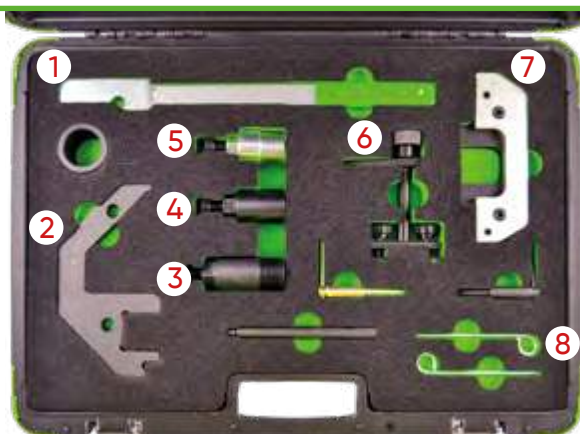

## KIT DE CALADO BMW

53266

210,00€



diesel

gasolina

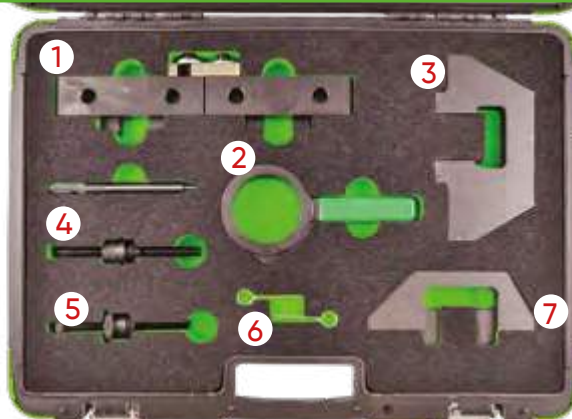

MARCAS	BMW
HERRAMIENTAS OEM	113240 (1), 115490 (2), 113190 (3), 112300 (4) (5), 113292 (6), 113320 (7)
CÓDIGOS DE MOTOR	GASOLINA: M42, M43, M50, M52, M60. DIESEL: M51

## KIT DE CALADO BMW M42 / 44 / 50 / 52 / 54 / 56

53267

255,50€



gasolina



MARCAS	BMW	SERIES: 3, 5, 7, X, Z
HERRAMIENTAS OEM	114220 (1), 112300 (2), 113240 (3), 115490 (4), 113292 (5), 113450 (6)	
CÓDIGOS DE MOTOR	M40. M44. M50. M52. M54. M56.	

## KIT DE CALADO BMW MINI PSA 1.4 / 1.6

53268

92,00€



gasolina

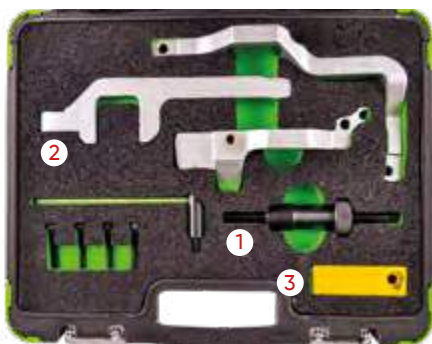

MARCAS	BMW MINI: Mini Clubvan R55 (12-14), Mini Clubman R55 (08-14), Mini Countryman R55 (07-10), Mini Clubman R56/R57 (07-15), Mini R56/R57 (08-15), Mini Coupe R58 (11-15), Mini Roadster R59 (08-15), Mini Clubman R60 (10-14), Mini Clubman R60 (12-14), Mini Roadster R61 (13-15), Mini Paceman R61 (14-15), Mini Countryman R60 (10-17). CITROËN: C4 (08-11), C4 Picasso (08-13) C4 Grand Picasso (13-15). PEUGEOT: 207 (06-14), 207CC (07-15), 308 (07-15), 3008 (09-15), 5008 (09-15).
HERRAMIENTAS OEM	BMW MINI: 11 5 590 (1), 11 9 340 (2), 11 9 551 (3) CITROËN: 0197-A1, 0197-A3, 0197-B. PEUGEOT: 0197-A1, 0197-A3, 0197-BZ.
CÓDIGOS DE MOTOR	14: N12B14, N14B14AB. 16: EP3(8FS), EP3C(8FR), EP6(5FW), EP6C(5FS), EP6CDT(5FV), EP6DT(5FT), EP6DT(5FX), EP6DTS(5FY), N14B16A, N14B16CD, N14B16TO, N14B16CD/TO, N16B16A, N16B16KO, N16B16A/MO, N16B16A/MO, N16B16MO, N16B16UO.

## KIT DE CALADO BMW

53269

49,50€



diesel

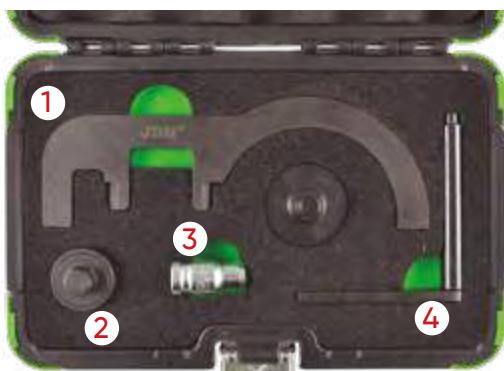

MARCAS	BMW	BMW 1 SERIES: 116d E81/82/87/88 (08-12), 118d E81/82/87/88 (07-14), 120d E81/82/87/88 (07-14), 123d E81/82/87/88 (07-14). BMW 2 SERIES: 218d (11-14), 220d (11-14), 225d (11-14). BMW 3 SERIES: 316d E90/91/92/93 (09-12), 318d E90/91/92/93 (07-12), 320d E90/91/92/93 (07-12), 325d E90/91/92/93 (10-14), 330d/xd E90/91/92/93 (08-14). BMW 5 SERIES: 520d E60/61 (07-10), 525d F10/11 (10-12), 530d F10/11 (10-13), 530dGT F07 (09-12), 535d F10/11 (10-17), 535dGT F07 (10-12). BMW 7 SERIES: 730d/Ld F01/02/04 (08-12), 740d F01/02/04 (09-12), 740d xDrive F01/02/04 (09-12), 750d xDrive F01/02/04 (12-15). BMW X SERIES: X1 sDrive 18d E84 (09-15), X1 sDrive 20d E84 (09-12), X1 xDrive 18d E84 (09-15), X1 xDrive 20d E84 (09-15), X1 xDrive 23d E84 (09-12), X3 2.0d E83 (07-10), X3 xDrive 18d E83 (08-10), X3 xDrive 30d E83 (11-12), X3 xDrive35d F25 (11-17), X5 3.0d E70 (10-13), X5 xDrive 40d X5 F15 M50d (13-17), E70 (10-13), X6 xDrive 30d E71/72 (10-14), X6 xDrive 40d E71/72 (10-14), X6 F16 M50d (14-17). BMW MINI: Paceman (13-17), Countryman (10-17), Mini (10-15), Roadster (12-14), Clubman (10-14), Clubvan (12-14).
HERRAMIENTAS OEM	11.8.760 (1), 1.8.740 (2), 11.6.480 (3), 11.5.320 (4)	
CÓDIGOS DE MOTOR	1.6 D: N47; C16K1, C16U1. 2.0 D: N47; C20K1, C20U1N47; D20, D20A, D20B, D20D, D20K1, D20O0, D20O1, D20T1, D20U0, D20U1, N47S D20T0, N47T; D20, D20O1, D20U1. 3.0 D: N57; B30B, B30B/T0, B30C, D30BT0, D30O0, D30O1, D30T0, D30T1, D30U0.	



## KIT DE CALADO MERCEDES M271

53271

213,50€



diesel

gasolina

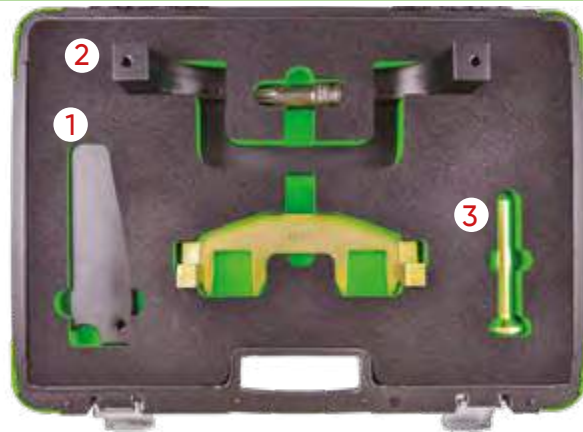

MARCAS	MERCEDES
HERRAMIENTAS OEM	271 589 003100 (1), 271589014000 (2), 271589001500 (3)
CÓDIGOS DE MOTOR	M271. E18ML 2002. DE18ML 2003 - 2005. E16ML 2008. DE18LA 2009.

## KIT DE CALADO MERCEDES AMG 156

53272

172,50€

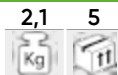

diesel

gasolina



MARCAS	MERCEDES
HERRAMIENTAS OEM	156 589 00 61 00 (1), 156 589 00 32 00 (2), 156 589 01 63 00 (3), 156 589 00 61 00 (3)
CÓDIGOS DE MOTOR	BENZ AMG 156.ML 63 AMG.S 63L AMG.S 63. AMG. R 63 AMG L 4MATIC. R63 AMG 4MATIC. E 63 AMG. CLS 63 AMG. CLK 63 AMG. CLK 63 AMG Black series. CLK 63 AMG Cabrio. CL 63 AMG.

## KIT DE CALADO MERCEDES M276 / M157 / M278

53273

68,00€

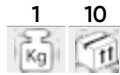

diesel

gasolina



MARCAS	MERCEDES		
HERRAMIENTAS OEM	27658901400		
CÓDIGOS DE MOTOR	<table border="0"> <tr> <td>CL 500 / 63 AMG (C 216) 2010-2013. S 500 / 63 AMG (C 217) 2014. CLS 300 (C 218) 2012. E 300 / 350 / 400 (C/A 207) 2011. CLS 350 / 400 / 500 / 63 AMG (C/X 218) 2011-2014. SLK 350 (R 172) 2011. SL 350 / 400 / 500 / 63 AMG (R 231) 2012. S 500 PLUG-IN HYBRID (V 222) 2014. ML 300 / 350 / 500 / 63 AMG (W 166) 2011.</td> <td>C 400 (W 205) 2014. E 400 HYBRID (W 212) 2012. G 63 AMG (W 463) 2012. E 300 / 350 / 400 / 500 / 63 AMG (W/S 212) 2011. C 350 (W/S/C 204) 2011. S 350 / 500 / 63 AMG (W/V 221) 2010. S 400 / 63 AMG (W/V 222) 2013. R 350 BlueEFFICIENCY (W/V 251) 2012. GL 450 / 500 (X 166) 2012. GLK 350 (X 204) 2011.</td> </tr> </table>	CL 500 / 63 AMG (C 216) 2010-2013. S 500 / 63 AMG (C 217) 2014. CLS 300 (C 218) 2012. E 300 / 350 / 400 (C/A 207) 2011. CLS 350 / 400 / 500 / 63 AMG (C/X 218) 2011-2014. SLK 350 (R 172) 2011. SL 350 / 400 / 500 / 63 AMG (R 231) 2012. S 500 PLUG-IN HYBRID (V 222) 2014. ML 300 / 350 / 500 / 63 AMG (W 166) 2011.	C 400 (W 205) 2014. E 400 HYBRID (W 212) 2012. G 63 AMG (W 463) 2012. E 300 / 350 / 400 / 500 / 63 AMG (W/S 212) 2011. C 350 (W/S/C 204) 2011. S 350 / 500 / 63 AMG (W/V 221) 2010. S 400 / 63 AMG (W/V 222) 2013. R 350 BlueEFFICIENCY (W/V 251) 2012. GL 450 / 500 (X 166) 2012. GLK 350 (X 204) 2011.
CL 500 / 63 AMG (C 216) 2010-2013. S 500 / 63 AMG (C 217) 2014. CLS 300 (C 218) 2012. E 300 / 350 / 400 (C/A 207) 2011. CLS 350 / 400 / 500 / 63 AMG (C/X 218) 2011-2014. SLK 350 (R 172) 2011. SL 350 / 400 / 500 / 63 AMG (R 231) 2012. S 500 PLUG-IN HYBRID (V 222) 2014. ML 300 / 350 / 500 / 63 AMG (W 166) 2011.	C 400 (W 205) 2014. E 400 HYBRID (W 212) 2012. G 63 AMG (W 463) 2012. E 300 / 350 / 400 / 500 / 63 AMG (W/S 212) 2011. C 350 (W/S/C 204) 2011. S 350 / 500 / 63 AMG (W/V 221) 2010. S 400 / 63 AMG (W/V 222) 2013. R 350 BlueEFFICIENCY (W/V 251) 2012. GL 450 / 500 (X 166) 2012. GLK 350 (X 204) 2011.		

## KIT DE CALADO MERCEDES / CHRYSLER / JEEP

53270

63,50€



diesel

gasolina

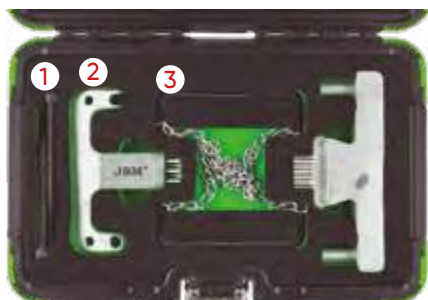

MARCAS	MERCEDES CHRYSLER JEEP
HERRAMIENTAS OEM	112 589 03 40 00 (1), 601 589 02 40 00 (2), 111 589 03 15 00 (3)
CÓDIGOS DE MOTOR	Herr.: 112 589 03 40 00: 112, 113, 137, 155, 156, 272/979, 273, 629, 642/992. Herr.: 601 589 02 40 00: 102, 103, 104, 111, 601, 602.91/93/94/96/983, 603.91/93/96/97, 604, 605, 606, 611, 612/965/966, 613. Herr.: 111 589 03 15 00: 111, 119, 604, 605, 606, 611/980, 612, 613, 628, 629, 640, 642/922, 612.965/966, 646, 647, 648.

## KIT DE CALADO DE DISTRIBUCION VAG 1.2/1.4 TSI

53648

3,70 2 40

gasolina

106,50€



MARCAS	AUDI: A1 (12-15), A1 Sportback (12-15), A3 (13-15), A3 Sportback (12-15). SEAT: Ibiza (12-15), Leon (12-15), Toledo (12-15). SKODA: Fabia (10-13), Octavia II (10-13), Octavia III (10-15).
HERRAMIENTAS OEM	T10060A (1), T10340 (2), T10476 (3), T10494 (4), T10499 (5), T10504/1 (6), T10504 (7), T10504/2 (8).
CÓDIGOS DE MOTOR	1.2 TSI: CJZA, CJZB. 1.4 TSI: CGGA, CHPA, CMBA, CPVA, CRJA, CXSA. 1.4 TSI ACT: CPTA.

## KIT ALINEACIÓN ÁRBOL DE LEVAS VAG 1.4/1.6/2.0 TDI COMMON RAIL

53706

1,5 5

diesel

88,00€



MARCAS	VOLKSWAGEN: Golf Alltrack, Golf Sportsvan, Golf VII, Golf VII Kombi, Passat, Polo. AUDI: A1, A1 Sportback, A3, A3 Cabriolet, A3 Limousine, A3 Sportback, TT, TT Roadster. SEAT: Ibiza, Ibiza V Sportcoupe, Ibiza V ST, Leon, Leon SC, Leon ST, Toledo IV. SKODA: Fabia, Fabia Kombi, Octavia, Octavia Combi, Rapid, Rapid Spaceback.
HERRAMIENTAS OEM	OEM 3204 (1), OEM 3359 (2), OEM T10490 (3), OEM T10051 (4), OEM T10060A (5), OEM T10264 (6), OEM T10265 (7), OEM T10492 (8), OEM T40098 (9).
CÓDIGOS DE MOTOR	1.4, 1.6, 2.0 TDI CR CXXB, DBKA, DCXA, CGLE, CKFB, CKFC, CLHA, CLHB, CNHA, CNHC, CRBD, CRFA, CRFC, CRKA, CRKB, CRLB, CRLC, CRMB, CRUA, CRVA, CRVC, CSUA, CSUB, CUNA, CUPA, CUSA, CUSB, CUTA, CUUD, CXEB, DBKA, DCXA, DCZA, DFSD.

## KIT ALINEACION ÁRBOL DE LEVAS VW / AUDI

53280

3,5 5 165

gasolina

102,50€



MARCAS	AUDI: A4 (01-08), A6 (01-08), A8 (03-10).
HERRAMIENTAS OEM	3387 (1), T40030 (2) (4), T40026 (3), T40028 (5)
CÓDIGOS DE MOTOR	3.0 V6 30v: ASN, AVK, BBJ, BGN.

## KIT DE CALADO AUDI V6 2.0 / 2.8 / 3.0 TFSI

53278

4,75 2 40

gasolina

141,50€

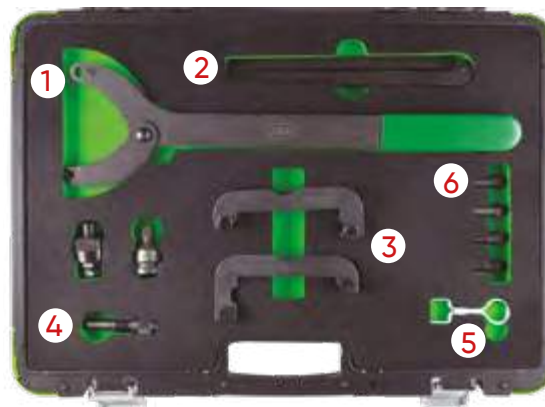

MARCAS	AUDI: Q5, V6 2.0, 2.8, 3.0T FSI SEAT: Ibiza/Cordoba, Toledo, Alhambra, Inca 1.6, 1.8, 1.8 16v, 2.0, 2.0 16v, Ibiza/ Cordoba, Leon, Toledo 1.6 (99-), Alhambra 2.0 (00-). VOLKSWAGEN: V6 2.0, 2.8, 3.0T FSI. AUDI/VOLKSWAGEN: V6 2.0, 2.8, 3.0T FSI. AUDI Q5: 2.0, A6L 2.8, 3.0T.
HERRAMIENTAS OEM	T10172 (1), 3212 (2), T40070 (3), T40069 (4), T40071 (5), T10172/2 (6)
CÓDIGOS DE MOTOR	2.0, 2.8, 3.0



## SET DE HERRAMIENTAS PARA LA CORREA DE DISTRIBUCIÓN BMW / AUDI

53277

1,6 5 165

45,00€



diesel

gasolina

MARCAS

GASOLINA

**AUDI:** 80, 100, A3, A4, A6 1.6, 1.8/Turbo, 2.0, 2.0 16v, A3, A4 1.6 (96-).  
**SEAT:** Ibiza/Cordoba, Toledo, Alhambra, Inca 1.6, 1.8, 1.8 16v, 2.0, 2.0 16v, Ibiza/Cordoba, Leon, Toledo 1.6 (99-), Alhambra 2.0 (00-).  
**VOLKSWAGEN:** Polo Classic, Scirocco, Corrado, Golf, Jetta, Vento, Passat, Sharan, Transporter 1.6, 1.8/Turbo, 1.8 16v, 2.0, 2.0 16v, Polo Classic, Golf, Bora, Beetle 1.6 (97-), 2.0 (99-).  
**SKODA:** Octavia 1.6 (97-), 2.0 (99-).

DIESEL

**AUDI:** 80, 100, A3, A4, A6 1.9 Turbo D, 1.9TDi, 2.5TDi, A3, A4, A6 2.0TDi, A2, A3, A4, A6 1.2TDi, 1.4TDi, 1.9TDi (99-).  
**SEAT:** Ibiza/Cordoba, Leon, Toledo, Alhambra, Inca 1.7SDi, 1.9D/TD /Sdi/Tdi.  
**FORD:** Galaxy (02-06).  
**SKODA:** Felicia, Octavia 1.9D/Tdi.  
**VW:** Polo, Polo Classic, Golf, Jetta, Vento, Bora, Beetle, Passat, Sharan, Caddy, Transporter 1.5D, 1.6D/Turbo, 1.7D/Sdi, 1.9Sdi/Tdi, Golf, Passat 2.0TDi.

HERRAMIENTAS OEM

T10020 (1), 3387 (2), V159 (3), T10060/T100604 (4), T10115 (5), T40011 (6)

CÓDIGOS DE MOTOR

2.0, 2.8, 3.0

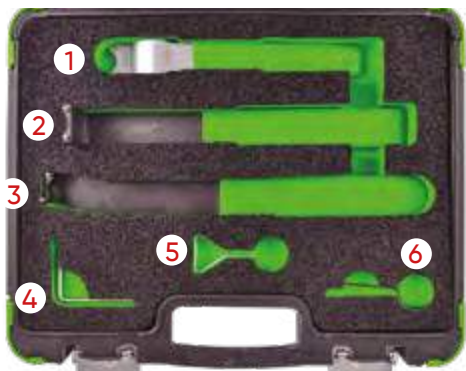

## KIT DE CALADO AUDI / SKODA

53276

5,3 2 40

156,00€



diesel

gasolina

MARCAS

**MOTORES AUDI/VW:** V6 2.0, 2.8, 3.0T FSI.  
**AUDI/Q5:** 2.0, A6L 2.8, 3.0T.

HERRAMIENTAS OEM

T0016 (1), T10123 (2) (3), T10098A (5), T10264 (7), T10265 (8), 3369 (12), T10120 (13), T10008 (15), T10060/T10060A (18), 2064 (19), T20102/3359 (21), T10050 (22) T10100 (23), 3458 (26)

CÓDIGOS DE MOTOR

2.0, 2.8, 3.0

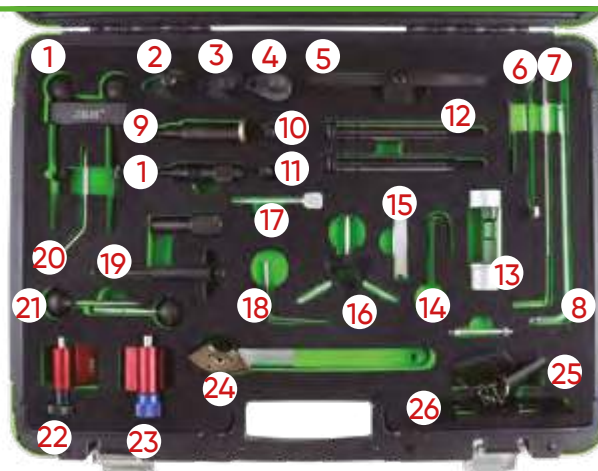

## KIT ALINEACION ÁRBOL DE LEVAS VW / AUDI

53281

1,3 5

53,50€



diesel

MARCAS

**VOLKSWAGEN:** 2.5 TDi V6 DIESEL  
**AUDI:** A4, A6, A8

HERRAMIENTAS OEM

3369 (1), 3242 (2), 3458 (3)

CÓDIGOS DE MOTOR

AFB/AKN



## KIT DE CALADO VW / AUDI

53282

1,75 5 135

48,00€



gasolina

MARCAS

**SEAT:** Alhambra (10-15), Altea/Altea XL (08-15), Ibiza/Cordoba (08-12), Leon (07-13), Toledo (07-15).  
**VOLKSWAGEN:** Beetle (11-15), Caddy/Caddy Maxi (10-15), EOS (06-12), Golf (03-12), Golf Plus (03-14), Golf V Estate (07-13), Golf VI Cabriolet (10-15), Jetta (06-14), Passat (05-11), Polo (02-14), Scirocco (08-12), Tiguan (07-12), Touran (03-15).  
**SKODA:** Fabia II (07-15), Octavia II (04-15), Praktik (10-15), Rapid (12-15), Roomster (06-15), Superb II (09-14), Yeti (09-14).  
**AUDI:** A1 (10-15), A3 (03-13).

HERRAMIENTAS OEM

T10171 (1), T10170 (2), T40011 (3)

CÓDIGOS DE MOTOR

1.2 TFSi: CBZA, CBZB, CBZC.  
 1.4 FSI: AXU, BKG, BLN.  
 1.4 TFSi: BLG, BMY, BWK, CAVA, CAVB, CAVC, CAVD, CAVE, CAVF, CAXA, CAXC, CDGA, CSMA.  
 1.6 FSI: BAG, BLF, BLP, BTS.



## KIT DE CALADO VW / AUDI 2.0 TFSI

**53279**  
90,00€

2,1 5 135  
Kg us ft

gasolina



### MARCAS

AUDI: A3 (96-09), A4 (94-09), A6 (95-11), S3 (99-13), TT (98-14).  
SEAT: Alhambra (97-10), Altea/Altea XL (06-09), Cordoba (99-02), Exeo (09-10), Ibiza (99-02), Leon (99-13), Toledo (99-09).  
SKODA: Octavia/Octavia Tour (98-10), Octavia II (04-09).  
VOLKSWAGEN: Beetle (99-11), Bora (97-04), Eos (06-10), Golf Plus (05-09), Jetta (05-09), Passat (96-10), Scirocco (09-14), Sharan (97-10), Touran (03-09).

### HERRAMIENTAS OEM

T10020 (1), T10252 (2), T10092 (3), T10115 (4), T40011 (4), 3366 (5), T10060 (6)

### CÓDIGOS DE MOTOR

1.8: ADR, AFY, AGN, AJP, APG, APT, AQE, ARG, ARH, AVV.  
1.8T: AEB, AGU, AJH, AJL, AJQ, AMK, AMU, ANB, APP, APU, APX, APY, AQA, AQX, ARX, ARY, ARZ, AUM, AUQ, AVC, AWC, AWT, AWU, AYP, BAM, BFV, BVP, BVY.  
2.0 TFSI: AXW, BHD, BLR, BLX, BLY, BMB, BVX, BVY, BVZ.  
2.0 TFSI/S/R/Tsi: AXX, BPY, BWA, BGB, BPG, BPJ, BUL, BWE, BWI, BYK, BHZ, BZC, BWJ, BYD, CDLA, CDLB, CDLC, CDLD, CDF, CDMA.

## KIT DE CALADO VOLKSWAGEN / SEAT / SKODA 1.2L

**53274**  
30,50€

1,05 5 10  
Kg us ft

gasolina

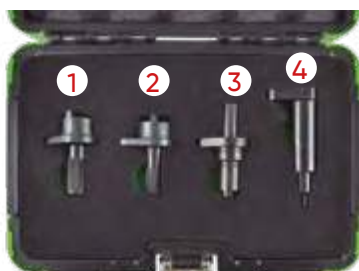

### MARCAS

VOLKSWAGEN  
1.2: Lupo / Polo / Eos / Fox.  
SEAT  
1.2: Ibiza / Cordoba  
SKODA  
1.2: Fabia

### HERRAMIENTAS OEM

T10123 (1) (2), T10120 (3), T10121 (4)

### CÓDIGOS DE MOTOR

AWY / BMD / AZQ / BME.

## KIT DE CALADO VW / AUDI

**53326**  
13,50€

0,3 10 40  
Kg us ft

diesel



### MARCAS

VW: V6 2.5TDI.  
AUDI: V6 2.5TDI, V8 3.3TDI.

### HERRAMIENTAS OEM

3458 (1), T40069 (2)

## KIT DE CALADO VW 1.2

**53327**  
11,00€

0,2 10 60  
Kg us ft

gasolina



### MARCAS

SEAT: Ibiza 1.2 6v/3cyl (2002-09), Cordoba 1.2 12v/3cyl (2002-13).  
VW: Polo 1.2 6v-12v/3cyl (2002-14).  
SKODA: Fabia 1.2 6v-12v/3cyl (2002, 2003-), Fabia II 1.2 6v/3cyl (2007-13), Roomster 1.2 12v/3cyl (2006-13), Praktik 1.2 6v/3cyl (2007-13).

### HERRAMIENTAS OEM

T10123.

### CÓDIGOS DE MOTOR

1.2 6v: AWY, BMD, BBM, CHFA, CHFB  
1.2 12v: AZQ, BME, BXV, BZG, CEVA, CGPA, CGPB.

## KIT DE CALADO GRUPO VAG 2.7 / 3.0 TDI

**53283**  
92,00€

2,1 5  
Kg us ft

diesel



### MARCAS

VOLKSWAGEN: Touareg, Phateon  
VAG: Diesel 2.7 / 3.0 V6  
AUDI: A4, A5, A6

### HERRAMIENTAS OEM

3242 (1), T40060 (2) (3), 3359 (4), T40058 (5), T40061 (6), T40062 (7), T40049 (8)

### CÓDIGOS DE MOTOR

ASB, BKN, BKS, BWZ, BNG, BPP, BSG, BUG, BUN, CAWA, CAMB, CANA, CANB, CANC, CAND, CAPA, CARA, CARB, CASA, CASE, CASC, CAM, CC/HA, CCWA, CCWB, CDYA, CDVB, CDVC, CEXA, CGKA, CGKB.



## KIT DE CALADO GRUPO VAG 2.5 / 4.9D / TDI

53284

285,00€



diesel

MARCAS	VOLKSWAGEN: Touareg (03-10), Transporter (03-09).
HERRAMIENTAS OEM	T10225 (1), T10199 (2), T10234 (3), T10226 (4), T10193 (5), T10194 (6), T10199/01 (7), T10226 (8)
CÓDIGOS DE MOTOR	2.5D TDi PD: AXD, AXE, BAC, BLJ, BLK, BNZ, BPC, BPD, BPE.

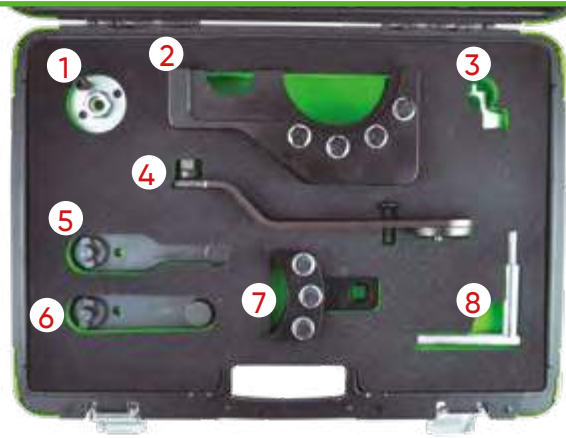

## KIT DE CALADO GRUPO VAG 2.4 / 2.5D SDI

53285

56,00€



diesel

MARCAS	VOLKSWAGEN: Crafter (06-13), LT (96-06), Transporter (90-03).
HERRAMIENTAS OEM	2065A (1), T50009 (2), T10025 (3), 3248/3419 (4), 2064 (5), 3355 (6)
CÓDIGOS DE MOTOR	2.4D: AAB, AJA. 2.5D SDI: AGX. 2.5D Tdi: ACV, AHD, AHY, AJT, ANJ, APA, AUF, AVR, AXG, AXL, AYC, AYY, BBE, BBF. 2.5D TDiCR: BJJ, BJK, BJL, BJM.



## KIT DE CALADO GRUPO VAG 1.8 / 2.0TSI

53286

87,00€



gasolina

MARCAS	VOLKSWAGEN: 1.8 / 2.0 TSI / TFSI.
HERRAMIENTAS OEM	T10368 (2), T10354 (3), T40271 (4), T10352/2 (5), T10352/1 (6), T10352 (7), T40196 (8) (9) (10) (11), T40267 (12) (13), T40098 (14), T10060A (15), T40011 (15)
CÓDIGOS DE MOTOR	BYT, BZB, CABA, CABB, CABD, CADA, CAEA, CAEB, CAWA, CAWB, CBFA, CCTA, CCZA, CCZB, CCZC, CDA, CDAB, CDHA, CDHB, CDNB, CDNC, CDND, CESA, CETA, CFKA, CGYA, CJEB, CJBA, CJSB.



## KIT DE CALADO VW / AUDI 1.8 / 2.0L TURBO

53287

228,50€



gasolina

MARCAS	VOLKSWAGEN AUDI	1.8 / 2.0 TURBO
HERRAMIENTAS OEM	T10355 (1), T40196 (2), T40271 (3) (4), T10352 (5), T10352/1 (6), T10352/2 (7), T10368 (7), T40267 (8), T10354 (9), T40265 (10), T40011 (11) (14), T40098 (12), T10060A (13)	
CÓDIGOS DE MOTOR	BYT, BZB, CABB, CABD, CADA, CAEA, CAEB, CAWA, CAWB, CBFA, CCTA, CCZA, CCZB, CCZC, CDA, CDAB, CDHB, CDNB, CDNC, CDND, CESA, CETA, CFKA, CGYA, CJEB, CJSB, CJSB.	

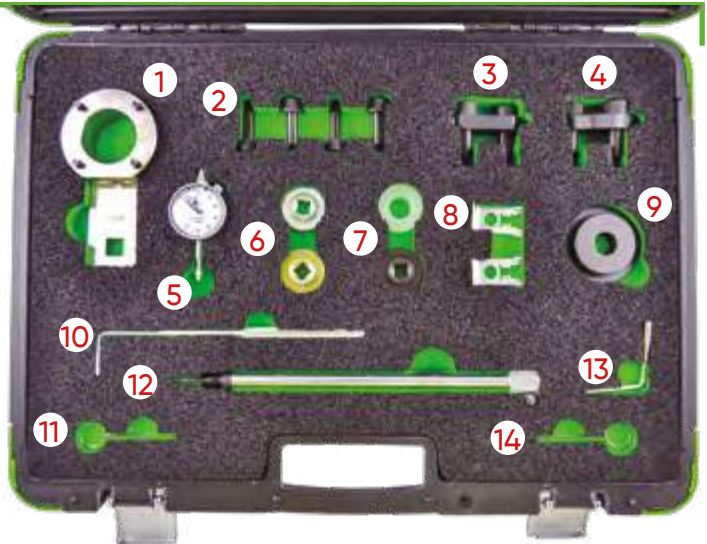

## KIT DE CALADO GRUPO VAG 1.6 / 2.0 TDI CR

53288

72,00€

2,15

5

**diesel**



### MARCAS

SEAT: Exeo, Leon, Altea, Toledo, Ibiza.  
VOLKSWAGEN: Jetta, Touran, Golf, Golf Plus, Polo, Passat, Tiguan, Scirocco.  
SKODA: Roomster, Fabia, Praktik, Octavia, Yeti, Superb.  
AUDI: A1, A3, A4, A5, Q5, A6, TT.

### HERRAMIENTAS OEM

T10264 (1), T10265 (2), T20102 (3), T10052 (4), T10051 (5), T10255 (6), T10050 (7), T10100 (8), T40098 (9)

### CÓDIGOS DE MOTOR

1.2 TDI CR, 1.6 D TDI CR, 2.0 D TDI CR

CAGA, CAGB, CAGC, CAHA, CAHB, CFHC, CBAA, CBAB, CFFB, CGLA, CGLB, CJCA, CJCB, CAAA, CBAA, CBAB, CBAC, CBBA, CBBB, CBDA, CBDB, CBDC, CCHA, CEGA, CJAA, CAAB, CAAC, CFJA, CFWA, CAYB, CAYC, CAYA.

## KIT DE CALADO AUDI / VW / SEAT / SKODA

53649

112,60€

3,53

2

42

**gasolina**

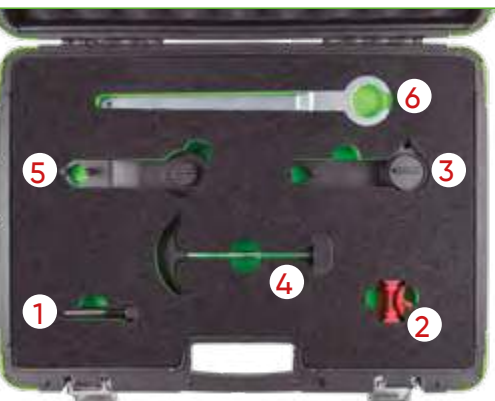

### MARCAS

AUDI SKODA  
SEAT VW

### HERRAMIENTAS OEM

T10340 (1), T10476 (2), T10477 (3), T10487 (4), T10494 (5), T10499 (6)

### CÓDIGOS DE MOTOR

1.0 MPI: CHYA.  
1.0 TSI: CHZE, CHZC, CHZA, CHZB, CHZC, CHZD, CHZJ.  
1.2 TSI: CJZB, CJZC, CYVA, CJZA, CJZD, CYVB.  
1.4 TSI: CZCC, CMBA, CZCA, CHPA, CPTA (ACT), CZDA, CVNA, CZIA (ACT).

## KIT DE CALADO GRUPO VAG

53275

35,50€

0,7 5 10 330

**diesel**

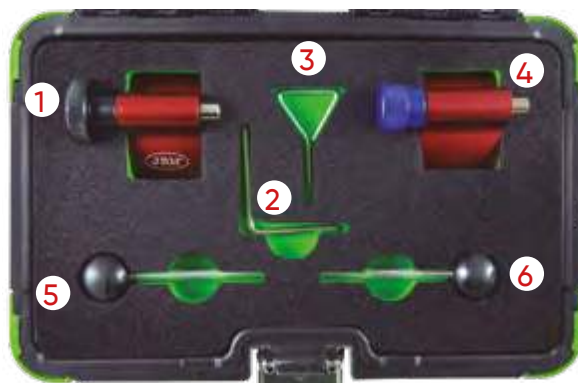

### MARCAS

DODGE: Caliber (06-11)  
FORD: Galaxy (02-06)  
MITSUBISHI: Grandis (05-10), Lancer (05-10), Outlander (07-10).  
SEAT: Alhambra (00-15), Altea/Altea XL (04-15), Cordoba (02-09), Ibiza (02-15), Leon (00-13), Toledo (04-11).  
SKODA: Fabia (00-14), Fabia II (07-15), Octavia (00-10), Octavia II (04-15), Praktik (10-15), Rapid (11-15), Roomster (07-15), Superb (02-08), Superb II (08-15), Yeti (09-14).  
AUDI: A1 (10-15), A2 (00-06), A3 (01-13), A4/Allroad (01-16), A5 (08-15), A6 (11-14), TT (08-14), Q3 (11-15), Q5 (08-15), A6 (10-14).  
VOLKSWAGEN: Amarok (10-16), Beetle (02-15), Bora (02-08), Caddy/Maxi (03-15), EOS (06-15), Fox (05-11), Golf (02-15), Golf Plus (05-14), Jetta (05-15), Lupo (02-05), Passat/CC (02-15), Polo (99-14), Scirocco (08-14), Sharan (02-15), Tiguan (07-15), Touran (03-15), Transporter (03-17).

### HERRAMIENTAS OEM

DODGE: 9882, 9883.  
FORD: 310-085/23-059, 303-1054.  
MITSUBISHI: MB995206, MB995208, MB995209.  
VAG: T10100 (4), T10050 (1), 3359 (3/6)/T20102, T10115 (3), T10060A (2)/T40098, T20167.

### CÓDIGOS DE MOTOR

1.2D TDI CR: CFWA.  
1.4D TDI PD: AMF, BAY, BMS, BNM, BNV, BWB.  
1.6D TDI CR: CAYA, CAYB, CAYC, CAYD, CAZE, CLNA.  
1.9D TDI PD: AJM, ANU, ARL, ASZ, ATD, AUY, AVB, AVF, AVQ, AWX, AXB, AXC, AXR, BJB, BKC, BLS, BLT, BMT, BPZ, BRM, BRR, BRS, BRU, BSU, BSV, BSW, BTB, BVK, BXE, BXF, BXJ.  
2.0D TDI CR/TDI PD: AZV, BDJ, BDK, BEW, BGW, BHW, BKD, BKP, BKQ, BLB, BMA, BMM, BMN, BMP, BMR, BNA, BPW, BRA, BRC, BRD, BRE, BRF, BRT, BSS, BST, BSY, BUY, BUZ, BVA, BVE, BVF, BVG, BVH, BWC, BWV, CAAA, CAAB, CAAC, CAAD, CAAE, CAGA, CAGB, CAGC, CAHA, CAHB, CBAA, CBAB, CBAC, CBBA, CBBB, CBDA, CBDB, CBDC, CBEA, CCHA, CCHB, CDBA, CDCA, CEGA, CFCA, CFFA, CFFB, CFFD, CFFE, CFGB, CFGC, CFHA, CFHB, CFHC, CFHD, CFHE, CFHF, CFJA, CGLA, CGLB, CGLC, CGLD, CJAA, CJCA, CJCB, CJCC, CLCA, CLCB, CLJA, CLLA, CNEA, ECD, ECD/BSY, ECD/BYL, ECE/BWD.

## KIT DE CALADO DE DISTRIBUCIÓN SEAT / VW / AUDI / SKODA

51943

199,50€

5,13 2 64

### MARCAS

AUDI: 80, 100, A2, A3, A4, A6, TT  
SEAT: Terra, Ibiza, Córdoba, Leon, Toledo, Inca, Alhambra  
SKODA: Fabia, Felicia y Octavia.  
VW: Lupo, Polo/Classic, Caddy, Golf, Jetta, Vento, Bora, New Beetle, Passat, Sharan, Transporter y LT

### HERRAMIENTAS OEM

3418/2065A (1), 3411 (2), 3458 (3), T40069 (4), 2064/U20003 (5), T10050 (6), 3359 (7), T10008 (8), 3387 (9), 2065A (10), 3418 (11), 3369 (12), T10016/T10074 (13), T40011 (14), T20038/MPI-312&T10098 (15), T10123 (16), T10121 (17), T10120 (18), T10115 (19), M5x55mm (20), T10004 (21), T10020 (22), T10252 (23), 3366 (24), T10060/T10060A (25), T10092 (26), T40026 (27), 3268 (28), T40011 (29)

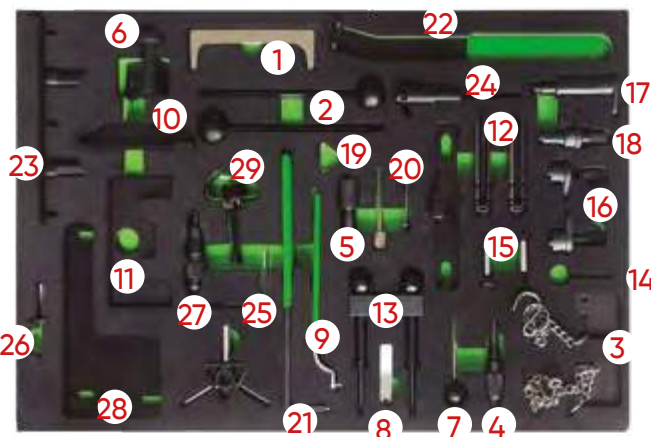



## KIT DE CALADO RENAULT 1.4 / 1.6 / 1.8 / 2.0 16V

53289

45,00€



gasolina

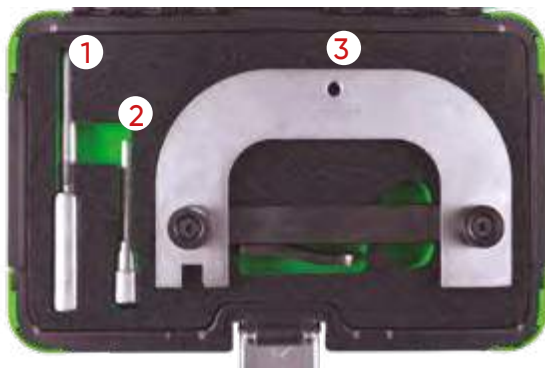

### MARCAS

**RENAULT:** Espace/Grand Espace (98-02), Espace/Grand Espace IV (02-10), Kangoo/Trekka (01-09), Laguna (98-01), Laguna II (01-07), Laguna III (07-13), Megane (99-03), Megane II (02-10), Megane III/Sport (08-13), Megane/Scenic (99-00), Scenic/RX4 (99-03), Scenic/Grand Scenic II (03-09), Trafic II (01-11), Twingo II (08-14), Vel Satis (00-10), Wind (10-14)  
**DACIA:** Logan/MCV (05-11).  
**NISSAN:** Kubistar X76 (03-09), Primastar (02-11).  
**VAUXHALL/OPEL:** Jetta, Touran, Golf, Golf Plus, Polo, Passat, Tiguan, Scirocco.

### HERRAMIENTAS OEM

Mot1489 (1), Mot1054 (2), Mot1496 (3)

### CÓDIGOS DE MOTOR

1.4 16v K4J: 730, 732, 740.  
 1.6 16v K4M: 752, 753, 760, 761, 764, 788, 812, 813, 854, 856.  
 1.8 16v F4P: 720, 722, 760, 770, 771, 772, 773, 774, 775.  
 2.0 16v F4R: 700, 701, 712, 713, 714, 715, 720, 722, 730, 732, 736, 738, 740, 741, 744, 746, 747, 762, 763, 764, 765, 766, 767, 770, 771, 780, 790, 791, 792, 820, 830, 832, 867.  
 2.0 16v F4R(t): 720, 722, 764, 765, 774, 776, 784, 786, 787, 794, 795, 796, 797, 800, 802, 810, 811, 870, 872, 874, 886, 887, 896, 897.

## KIT DE CALADO RENAULT

53291

68,00€



gasolina

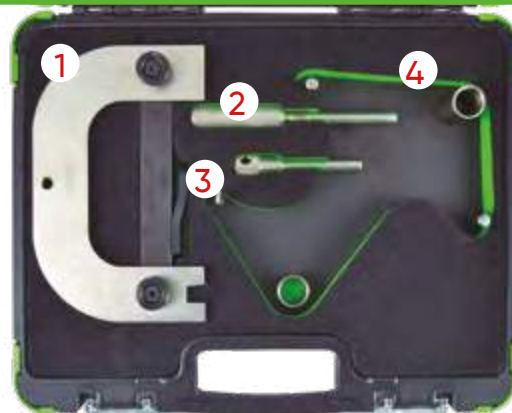

### MARCAS

**RENAULT:** Clio, Laguna, Megane

### HERRAMIENTAS OEM

MOT1496 (1), MOT1489 (2), MOT861/1863 (3), MOT1490 (4)

### CÓDIGOS DE MOTOR

K4J, K4M, F4P, F4R.

## KIT DE CALADO RENAULT / VOLVO 16V / 20V

53290

51,00€



gasolina

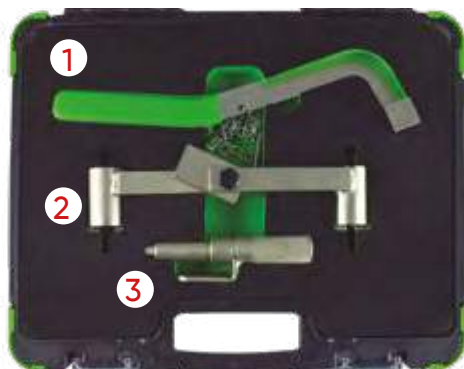

### MARCAS

**RENAULT:** Laguna 2.0 16V / 2.5 20V (1996-1999), Safrane 2.0 16V / 2.5 20V (1996-2001)  
**VOLVO:** 850 (1992-1997), C70 (1998-2002), S40 (1996-2004), V40 (1996-2004), S60 (2001-2005), S70 (1997-2000), S80 (1999-2005).

### HERRAMIENTAS OEM

MOT1348 (1), MOT1337 (2), MOT1340 (3)

### CÓDIGOS DE MOTOR

**RENAULT:** N7Q 704/710/711(2.0 16V), N7U 700/701(2.5 20V).  
**VOLVO:** B4164S, B4164S2, B4184S, B4184S2, B4184S3, B4184S9, B4184S10, B4194T, BS194T2, B420S4, B4204S2, B4204T, B4204T2, B4204T3, B4204T5, B5202Fs, B5204FT, B5204T2, B5204T3, B5204T4, B5204T5, B5234FS, B5204FT, B5234T3, B5234T4, B5234T5, B5234T6, B5234T7, B5234T8, B5234T9, B5244S, B5244S2, B5244SG, B5244SG2, B5244T, B5244T3, B5244T4, B5244T5, B5244T7.

## KIT DE CALADO RENAULT / NISSAN 1.6dCi

53523

89,60€

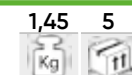

diesel



### MARCAS

**RENAULT:** Espace/Grand Espace IV (06-10), Kaleos (08-11), Laguna II (05-07), Laguna III (07-12), Master III (10-12), Magane II (06-10), Scenic/Grand Scenic II (06-09), Scenic/Grand Scenic III (09-12), Trafic II (06-12), Vel Satis (05-10)  
**NISSAN:** Primastar X83 (06-10), Qashqai/Qashqai+2 J10 (07-10), X-Trail T31 (07-12).  
**VAUXHALL / OPEL:** Movano-B (10-12), Vivaro (06-12).

### HERRAMIENTAS OEM

MOT1969 (1), MOT1970 (2), MOT1770, MOT1773, EN-48330, EN-48332, EN-48334, EN-48831, KM-6130

### CÓDIGOS DE MOTOR

M9R 2.0dCi: 610, 615, 630, 700, 721, 740, 742, 760, 761, 762, 763, 780, 782, 784, 786, 788, 800, 802, 803, 805, 808, 816, 830, 832, 833.  
 M9T 2.3dCi: 670, 672, 676, 678, 680, 686, 690, 692, 694, 698.

## KIT DE CALADO RENAULT / NISSAN / OPEL / VOLVO

53769

5,90

3

36

diesel

gasolina

170,00€

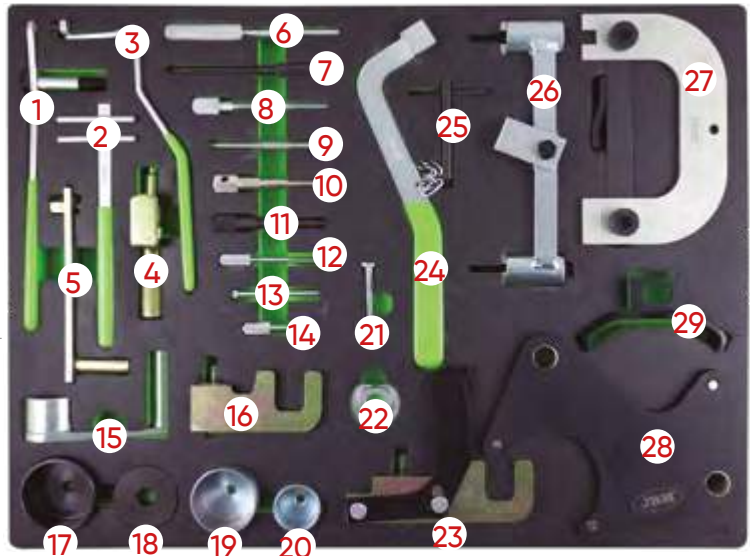

<b>MARCAS</b>	<p><b>RENAULT:</b> Avantime, Clio, Espace, Kangoo, Laguna, Master, Megane, Modus, Scenic, Twingo, Traffic.  <b>OPEL/VAUXHALL:</b> Movano, Vivaro.  <b>DACIA:</b> Dokker, Duster, Logan, Sandero.  <b>NISSAN:</b> Almera, Interstar, Kubistar, Micra, Note, Primera, Qashqai.  <b>VOLVO:</b> S40, V40</p>
<b>HERRAMIENTAS OEM</b>	<p>MOT 1312 (1), MOT 1135-01 (2), MOT 1384 (3), MOT 1340 (4), MOT 1543 / KM-6234 / KV113 B0360 (5), MOT 1489 / KV113 B0130 (6), MOT 1536 / KM-6203 (7), MOT 1489 (8), MOT 1054 / KM-6031 / KV113 / B0280 (10), MOT 1318 (11), MOT 910 (12), MOT 910 (14), MOT 1386 (15), MOT 1534 / KM-6205 (16), MOT 1543 / KM-6234 / KV113 B0360 (17), MOT 1543 / KM-6234 / KV113 B0360 (18), MOT 1543 / KM-6234 / KV113 B0360 (19), MOT 1543 / KM-6234 / KV113 B0360 (20), MOT 1386 (22), MOT 1537 / KM-6204 (23), MOT 1348 (24), MOT 1538 (25), MOT 1337 (26), MOT 1496 / MOT 1750 (27), MOT 1490-01 (28), MOT 1200-01 (29)</p>
<b>CÓDIGOS DE MOTOR</b>	<p><b>GASOLINA:</b> 2.0 16V, 2.5 20V, 1.4, 1.6 16V, 1.8, 2.0 16V, 1.2, 1.7, 1.8, 2.0 16V, 2.2  <b>DIESEL:</b> 1.9, 2.5, 2.8</p> <p>D4F702/706/708/712/714/716/722/728/730/740/764, D7F700/701/710/720/722/726/730/744/746/764/766, E7F700/704/706/750, E7J601/624/626/634/635/680/700/706/710/711/716/718/719/720/724/726/728/740/742/745/754/756/757/764/770/771/773/780, F3P670/682/700/704/706/708/710/712/714/720/724/755/758/760, F7P704/722, F3R611/722/723/728/729/750/751/752/791/796/797/798, F5R700/701/740, J7R732/733/734/735/768, F7R710/714, J71600/760/761/762/766/772/780/782, N7Q704/710/711, N7U700/701, K4J700/710/711/712/713/714/715/730/732/740/750/770/780, K4M700/701/704/706/707/708/709/710/711/712/714/716/718/720/724/730/732/734/736/740/742/743/744/745/746/748/750/752/753/754/760/761/762/764/765/766/768/776/782/788/790/791/794/800/801/802/804/812/813/830, K9K700/702/704/706/710/712/714/716/718/722/724/728/729/732/734/740/750/752/760/762/764/766/768/802/804/806, F9Q610/650/664/670/674/71/716/717/718/720/722/730/731/732/733/734/736/738/740/744/748/750/752/754/758/759/760/768/762/770/772/774/780/782/784/786/788/790/796/800/803/804/808/812/816/818/820, G9T600/605/700/702/703/706/707/710/712/720/722/742/743/750, G9U720/724/726/730/750/754, F8M736/760, F8Q600/610/606/620/622/624/630/632/640/644/646/648/662/672/678/680/682/684/692/696/706/714/720/722/730/732/740/742/744/764/768/770/6/776/784/786/788, J8S620/621/622/758/760/776/778, G8T714/716/740/752/760/790/792/794, S8U720/722/730/731/742/748/750/752/770/772/780/782, S9U700/702/704/714/740, S9W700/702/206/208/212, E5F, E6J, K7M, F4P/F4R, F1N, F2N, F3N, F2R, F3P, F4P, F3R, J5T, J6R, J7R</p>

## KIT DE CALADO RENAULT / OPEL 2.2 / 2.5 TDI DCI

53292

2,35

5

165

gasolina

116,00€



<b>MARCAS</b>	<p><b>RENAULT:</b> Laguna II, Espace, Master, Traffic, 2.2 / 2.5 DCI  <b>OPEL:</b> Vivaro, Movano, DIESEL: 2.2 / 2.5 DTI, Astra B, Vectra B, Signum, Zafira, 2.2 16V</p>
<b>HERRAMIENTAS OEM</b>	<p>KM6205 (1), KM6204 (2), KM6077 (3)</p>
<b>CÓDIGOS DE MOTOR</b>	<p>2.2 / 2.5</p>

## KIT DE CALADO FORD

53293

4,15

2

40

diesel

gasolina

133,50€

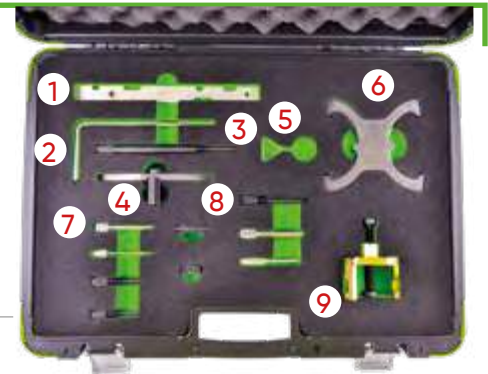

<b>MARCAS</b>	<p><b>FORD</b> B-Max (12-17), C-Max (07-17), Cougar (98-01), Courier (00-02), Escort (94-98), Fiesta (95-17), Focus (98-17), Focus C-Max (03-07), Fusion (02-12), Galaxy (06-15), Grand C-Max (10-17), Kuga (08-15), Maverick (01-07), Mondeo (93-15), Orion (94-94), Puma (97-02), S-Max (06-15), Tourneo Connect (02-15), Transit (06-11), Transit Connect (02-16), EcoSport (13-15), Tourneo Courier (14-15), Grand Tourneo Courier (13-15).</p>
<b>HERRAMIENTAS OEM</b>	<p>303-376 (21-162B) (1), 303-1059 (2), 303-193 (21-104) (3), 303-393-01 (4), 303-1054 (5), 303-1097 (6), 303-748 (7), 303-734 (21-262) (8), 303-651 (21-229) (9), 303-393A (21-168) / 303-393-02 / 303-507 (21-210) / 303-620 (21-163) / 303-732 (21-260) / 303-735 (21-263).</p>
<b>CÓDIGOS DE MOTOR</b>	<p><b>GASOLINA:</b> AODA/B, ASDA, ASDB, CFBA, CGBA/B, CHBA/B, CJBA/B, CSDA/B, DHA, DHB, DHC, DHD, DHE, DHF, DHG, EDBB, EDBD, EDDB, EDCC, EDDD, EDDF, EYDB, EYDC, EYDD, EYDE, EYDF, EYDG, EYDI, EYDJ, EYPA, EYPC, F8JA, F8JB, F8A, F8B, F8C, F8D, F8E, F8F, FUJA, FUJB, FXDA/C, FXDB/D, FXJA, FXJB, FYDA/C, FYDB/D, FYJA, FYJB, HWDA, HWDB, L1F, L1J, L1L, L1N, L1Q, L1T, L1V, L1W, M7JA, M7JB, MHA, MHB, NGA, NGB, NGC, NGD, QQDA/B/C, QQDB, RKA, RKB, RKF, RKH, RKJ, RKK, HXDA.  <b>DIESEL:</b> F6JA, F6JB, F6JC, HHJA, HHJB, G8DA, HHDA, HHDB, RTN, RTQ, RTP, C9DC, BHDA/B, BHPA, C9DA/B, F9DA/B, FFBA, FFDA, HCPA, HCPB, KKDA, P7PA, P9PA, Q9WA, R2PA, R3PA, RWPA, G6DA, G6DB, G6DC, AZWA, QXWA.</p>



## KIT DE CALADO FORD

53653

195,00€



gasolina

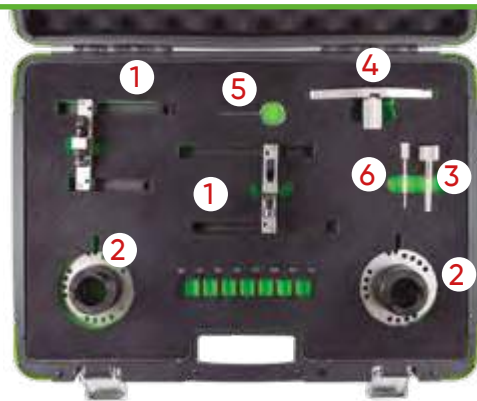

<b>MARCAS</b>	FORD: Fiesta, Focus, B-MAX, EcoSport.
<b>HERRAMIENTAS OEM</b>	303-1605 (1), 303-1606 (2), 303-1604 (3), 303-1602 / 503-393A / (21-168) (4), 303-1054 (5), 303-732 (6)
<b>CÓDIGOS DE MOTOR</b>	M1DD, M1JA, M1JC, M1JE, M1JHM1JJ, M1DA, M2DA, M2DB, M2DC, SFDBSFJA, SFJB, SFJC, SFJD

## KIT DE CALADO FORD

53324

12,50€



gasolina



<b>MARCAS</b>	FORD: B-Max (15-17), C-Max (07-10), Cougar (98-01), Fiesta (95-17), Focus (98-11), Focus C-Max (03-07), Fusion (02-12), Galaxy (06-15), Maverick (01-07), Mondeo (93-15), Puma (97-02), S-Max (06-15), Tourneo Connect (02-06), Transit (06-12), Transit Connect (02-06). MAZDA: 121 ZQ (95-00), 2 DY (02-07), 3 BK (03-09), 3 BL (09-15), 5 CR (05-10), 5 CW (10-12), 6 GG/GY (02-07), 6 GH (07-15), MPV LW (02-05), MX-5 NC (05-16), Tribute EP (04-06). VOLVO: C30 (06-13), S40 (06-12), S80 (07-11), V50 (04-12).
<b>HERRAMIENTAS OEM</b>	FORD: 303-1054, 303-507 (21-210), 303-620 (21-163), 303-574, 303-748, 303-376 (21-162B), 303-376B MAZDA: 49 JE01 061, 303-574, 49 JE02 061, 303-465, 49 JE01 054 VOLVO: 999 7152, 999 7151.
<b>CÓDIGOS DE MOTOR</b>	1.4 / 1.6

## KIT DE CALADO FORD 1.8TDDI / TDCI

53295

77,00€



diesel



<b>MARCAS</b>	FORD	C-Max (07-10), Courier (00-02), Fiesta (00-02), Focus (98-11), Focus C-Max (03-07), Galaxy (06-10), Mondeo (07-10), S-Max (06-14), Tourneo Connect (02-13), Transit Connect (02-13).
<b>HERRAMIENTAS OEM</b>	303-193 (21-104) (1), 303-393 (21-168) (2), 303-376 (21-162B) (3), 303-652 (21-230) (4), 310-095 (23-067) (5)	
<b>CÓDIGOS DE MOTOR</b>	1.8D TDCi: BHPA, F9DA, F9DB, FFBA, FFDA, FFWA, HCPA, HCPB, KHBA, KKDA, KKDB, P7PA, P9PA, P9PB, QYBA, QYWA, R2PA, R3PA, RWPA, RWPC. 1.8D TDCi ECOnetic: KHBA. 1.8D Tdi: BHDA, BHDB, BHPA, C9DA, C9DB, C9DC. 1.8D Turbo: C9DC, RTN, RTP, RTQ.	

## KIT DE CALADO FORD / MAZDA

53294

119,00€



diesel

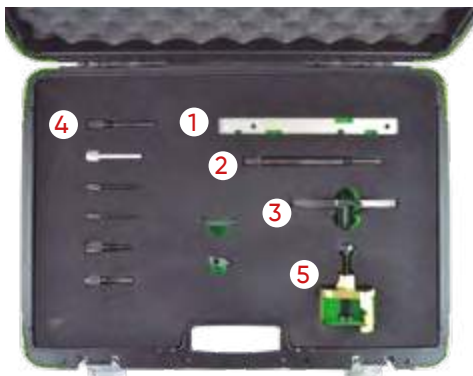

<b>MARCAS</b>	FORD: Courier (00-02), C-Max (03-10), Fiesta (02-11), Focus (98-11), Fusion (02-11), Galaxy (06-10), Kuga (06-10), Mondeo (07-10), S-Max (06-10), Tourneo Connect (02-13), Transit Connect (02-13). PEUGEOT: Bipper (08-10) Dispatch/Jumpy III (07-12) Expert III (07-12) Nemo (08-10) Partner I/II (05-11) Partner III (08-16) 107 (05-10) 1007 (05-10) 206 (01-12) 206+ (09-13) 206 CC (05-07) 207 (06-13) 207 CC (07-15) 208 (11-15) 307 (01-08) 308 (07-15) 308 CC (09-15) 407 (05-11) 508 (04-15) 2008 (13-15) 3008 (09-15) 4008 (12-15) 5008 (09-15). MAZDA: 2 (02-15), 3 (09-14). CITROËN: C1 (05-10), C2 (03-10), C3 I/II (02-10), C3 III (10-15), C3 Pluriel (04-10), C3 Picasso (09-12), C4 (04-11), C4 II (11-15), C4 Picasso (06-12), C4 Grand Picasso (10-12), DS3 (09-12), DS4 (11-12), DS5 (12-15), C5 II (04-08), C5 III (04-12), Xsara II (02-04), Xsara Picasso (04-10).
<b>HERRAMIENTAS OEM</b>	FORD: 303-376B (1), 303-193 (2), 303-393 (3), 303-732 (4), 303-651 (5), 303-393/01, 303-1059, 303-734, 303-735. MAZDA: 303-732, 303-734, 303-735. PSA: 0194-A, 0194-C, 0194B.
<b>CÓDIGOS DE MOTOR</b>	1.4D TDCi/Hdi: DV4TD(8HT), DV4TD(8HX), DV4TD(8HZ), DV4TD(8HW), DV4TED4(8HX), DV4TED4(8HV), DV4TED4(8HY), DV4C(8HP), DV4C(8HR), DV4TED(8HS), F6JA, F6JB, F6JC. 1.6D TDCi/HDi: DV6TED4(9HZ), DV6ATED4(9HX), DV6TED4(9HY), DV6DTE(9HP), DV6C(9HR), DV6ATED(9HX), DV6C(9HL), DV6TED(9HP), DV6ATED(9HY), DV6TED4(9HV), DV6TED4(9HX), DV6C(9HD), DV6C(BHX), DV6C(BHZ), DV6(9HR), DV6BTED4(9HW), DV6DTE(9HJ), DV6TED(9HN), DV6TED4BU(9HS), DV6BTED4(9HT), DV6BUTED4(9HT), DV6TED4B(9HV), DV6UTED4(9HX), DV6TED(9HD), DV6UTED4(9HU), DV6D(9HP), DV6TE-D4(9HV), DV6C(9HD), DV6TED4(9HW), DV6AT(9HX), DV6ATED(9HX), DV6CTED(9HC), DV6AUTED4(9HX), DV6TED4B, DV6DTE(9HF), HHJA, HHJB, G8DA, G8DB, HHDA, HHDB, MZ-CD, Y6. 1.8D TDCi/HDi: BHPA, C9DA/B, FFBA, G6DA, G6DB, G6DC, HCPA, HCPB, KKDA, P7PA, P9PA, R2PA, R3PA, RWPA. 1.8d: C9DC, RTN, RTQ. 1.8D Tdi: C9DA/B, C9DC. 2.0D TDCi/HDi: AZWA, G6DA, G6DB, G6DC, RHE(DW10CTED4), QXWA, QXWB.

## KIT DE CALADO PARA BOMBA DE INYECCIÓN FORD Y JAGUAR DURATORQ

53296

60,00€



diesel

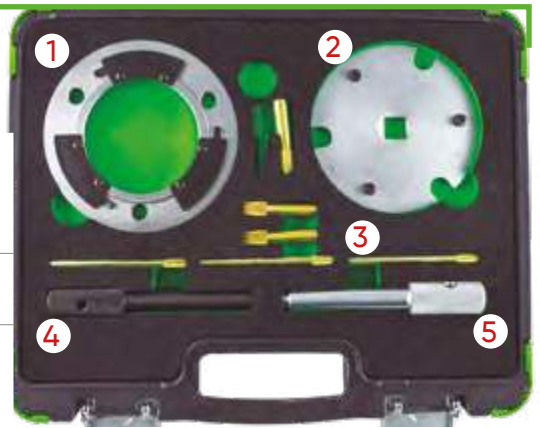

### MARCAS

FORD: Mondeo (00-07), Transit (00-14).  
CITROËN: Relay, Jumper III (06-13).  
FIAT: Ducato (06-11).

JAGUAR: X-Type (03-10).  
PEUGEOT: Boxer III (06-12).  
LAND ROVER: Defender Td4 (06-11).  
LDV: Convoy (02-06).

### HERRAMIENTAS OEM

303-1151 (1), 303-679A/21-238 (2), 303-732 (3), 303-675/21-234 (4), 303-698/21-251 (5)

### CÓDIGOS DE MOTOR

12.0D Di/TDci/TDCi: ABFA, D3FA, F3FA, D5BA, D6BA, F5FA, FMBA, FMBB, HJBA, HJBB, HJBC, HJBE, N7BA, N7BB.  
2.2D TDCi/ECOnetic: BG, CYFA, CYFB, CYFC, DRFA, DRFB, DRFC, P8FA, P8FB, PGFA, PGFB, QJBA, QJBA (BG), QJBB, QJBC, QJBD, QVFA, QVFB, SRFA, SRFB, SRFC, SRFD, SRFE, UHFA.  
2.2D HDi/JTD: P22DTE (4HM), P22DTE (4HU), P22DTE (4HV).  
2.4D Di/TDCi: DOFA, D2FA, D2FB, D4FA, F4FA, FXFA, H9FA, H9FB, H9FD, JXFA, JXFC, PHFA, PHFC.  
2.4D TD/Tdi: ZSD 424.  
2.4D Td4: 244DT.

## KIT DE CALADO JAGUAR / LAND ROVER

53297

44,50€



diesel

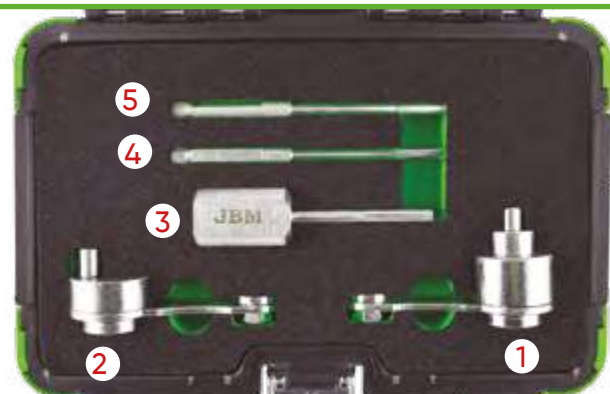

### MARCAS

JAGUAR: MS TypeTDVi.  
LAND ROVER: Discovery 2.7 TDV6.  
RANGE ROVER: Sport 2.7 TDV6.

### HERRAMIENTAS OEM

303-1117 (1), 303-1116 (2), 303-1132 (3), 303-1126 (4) (5)

### CÓDIGOS DE MOTOR

276DT, 306DT.

## KIT DE CALADO LAND ROVER

53298

84,50€

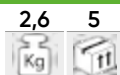

### MARCAS

MOTORES DIESEL: 200 TDI. 300 TDI. 2.5

- Pasador de sincronización de transmisión manual EDC.
- 200 TDI. 300 TDI. 2.5 Motores diésel.
- Extractor de amortiguador del cigüeñal.
- Herramienta de bloqueo de la bomba de inyección.
- Perno de sincronización de la bomba de inyección 200/300 TDI.
- Herramienta de sincronización del volante de motor 200/300 TDI.
- Herramienta de sincronización de bomba DPS 2.5.
- Herramienta de sincronización del volante de motor 2.5.



## KIT DE CALADO OPEL / FORD / FIAT / ALFA ROMEO / LANCIA / SUZUKI

53452

26,50€



diesel

### MARCAS

VAUXHALL/OPEL 1.3 CDTi: Agila, Corsa, Combo (03-08), Astra-H(05-08), Meriva, Tigra-B(04-08)  
SUZUKI 1.3 DDiS: Ignis, Wagon R(03-08), Swift(04-08)  
FORD: 1.3 TDCi  
FIAT/ALFA ROMEO/LANCIA: 1.3 JTD Multijet

### HERRAMIENTAS OEM

104-A EN 46781 (1), EN 46785 (2)

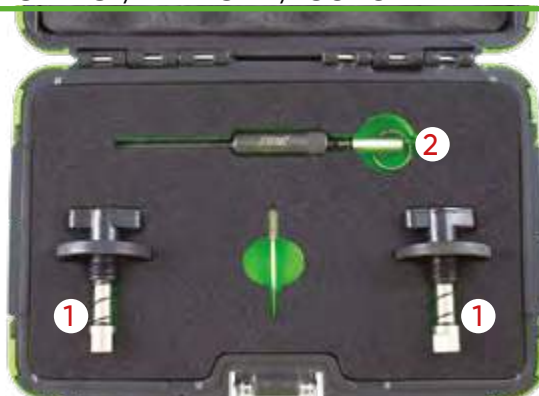



## KIT DE CALADO OPEL / VAUXHALL / CHEVROLET 2.0CDI

53300

40,50€



diesel

MARCAS	OPEL VAUXHALL CHEVROLET
HERRAMIENTAS OEM	EN-48245 (1), EN-48246 (2), 205083060 (3) (4) (5) (6)
CÓDIGOS DE MOTOR	DIESEL 2.0 CDI  OPEL / VAUXHALL: Z20DM, Z20DMH CHEVROLET: LLWZ20DMH, RA 420, Z20SI, Z 20S3, Z 20S4, Z 20S5

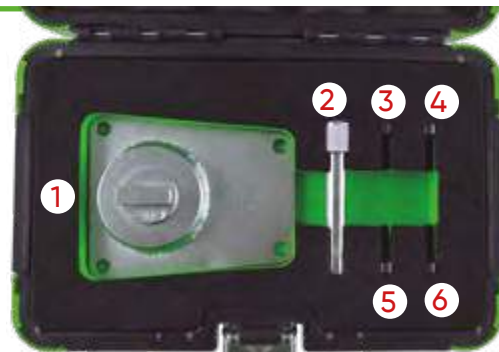

## KIT DE CALADO OPEL / VAUXHALL

53299

267,00€



diesel

MARCAS	OPEL / VAUXHALL
HERRAMIENTAS OEM	EN-46788 (1), KM927 (2), EN-46789 (3), KM929 (4), EN-46785 (5), EN-46788 (6), 1 860 985 000 (7), KM932 (8), KM933 (9), EN-49978 (10), KM933 (11)
CÓDIGOS DE MOTOR	1.3 CDTi 16V, 1.9 CDTi, 2.0 DTi, 2.2 DTi.



## KIT DE CALADO OPEL / VAUXHALL 1.0 1.2 1.4 TURBO

53651

82,50€



gasolina

MARCAS	OPEL: Adam, Ampera, Astra-J, Aveo, Corsa-D, Insignia, Meriva-B, Mokka, Zafira-C Tourer
HERRAMIENTAS OEM	EN 49977-100 (1), EN 49977-200 (2), EN 49978 (3), KM 952 (4), KM 953-A (5), KM 955-1 (6), KM 955-2 (7).
CÓDIGOS DE MOTOR	1.0: A10XEP (LDB) 1.2: A12XEL (LWD), A12XER (LDC) 1.4: A14XEL (L2Z), A14XER (LDD), LDU A14NEL (LUH), A14NET (LUJ), Twinport / ecoFLEX engines A14XFL (LUU), A14NEL (LDD), A14NEL (LUJ), A12XEL (L2Q)



## KIT DE CALADO OPEL 1.0 / 1.2 / 1.4

53301

44,00€



gasolina

MARCAS	SUZUKI: Wagon R (05-08). VAUXHALL / OPEL: Agila (00-08), Astra-G (98-06), Astra G Classic II (03-10), Astra-H (04-11), Combo (04-12), Corsa-B (97-00), Corsa-C (00-07), Corsa-D (06-12), Meriva-A (04-10), Tigra-B (04-10).
HERRAMIENTAS OEM	KM-953/09919-58310 (1), KM-952/09912-38310 (2), KM-954/09919-08310 (3), KM-6130 (4), KM-955/09919-58320 (5)
CÓDIGOS DE MOTOR	1.0 12v: X10XE, Z10XE, Z10XEP. 1.2 16v: X12XE, Z12XE, Z12XEP. 1.4 16v/ecoFLEX: Z14XEL, Z14XEP.

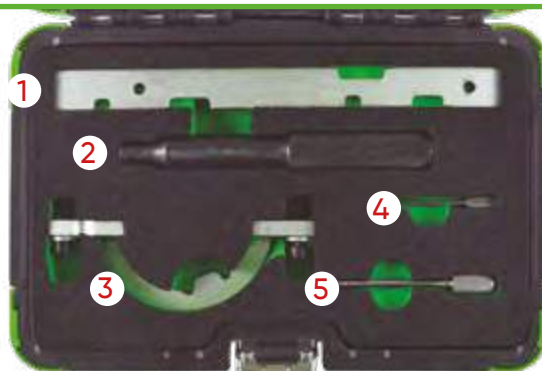

OPEL - VAUXHALL

## KIT DE CALADO OPEL / VAUXHALL ASTRA, VECTRA, ZAFIRA 1.9CDTI

53302

44,00€



diesel



MARCAS	SAAB: 9-3 (04-08), 9-5 (05-08). VAUXHALL / OPEL: Astra-H, Vectra-C, Signum (04-07), Zafira-B (05-07).
HERRAMIENTAS OEM	EN46789/32 025 008 (1) (3), EN46788/32 025 009 (2), KM6349 (4)
CÓDIGOS DE MOTOR	Z19DT, Z19DTH, Z19DTL.

## KIT DE CALADO FIAT / OPEL

53303

89,00€



diesel



MARCAS	FIAT: 19D/JTD (Motor Peugeot), 2.4D. ALFA ROMEO: 145, 146, 156 JTD. GM: GM 1.3, 1.6, 1.9, 2.0, 2.4 CDTi (2004 -).
HERRAMIENTAS OEM	EN-46789 (1), EN-46789-100 (2), EN-46785 (3), EN-46788 (4), EN-46781 (5), EN-46789 (6)
CÓDIGOS DE MOTOR	GM: K1.3 CDTi   Z13DT Common Rail engine. 1.9 CDTi / 04-12 - Z19DT   Z19DTH   Z19DTJ   Z19DTL 2.0 CDTi / 08-12 - A20DT   LBS / LBX / LBY / LCDV SAAB: 1.9 TID.

## KIT DE CALADO SAAB / OPEL / VAUXHALL

53305

135,50€



gasolina



MARCAS	VAUXHALL / OPEL: Antara (06-10), Calibra (93-98), Cavalier/Vectra-A (93-95), Omega-B (94-03), Signum (03-05), Sintra (96-99), Vectra-B (95-02), Vectra-C (02-05). SAAB: 900 (93-98), 9000 (95-97), 9-5 (98-03)
HERRAMIENTAS OEM	KM-800-1 (1), KM-800-2 (2), KM-800-20 (3), KM-800-10 (4), 83 95 006 (5), KM-800-30 (6), MKM-6038, 83 95 006 (7)
CÓDIGOS DE MOTOR	2.5 V6: Saab; B2581, Vauxhall/Opel; C25XE, X25XE. 2.6 V6: Vauxhall/Opel; Y26SE. 3.0 V6: Saab; B308E, B308i; Vauxhall / Opel; X30XE. 3.2 V6: Vauxhall/Opel; Y32SE, Z32SE.

## KIT DE CALADO FIAT

53304

257,50€



diesel gasolina

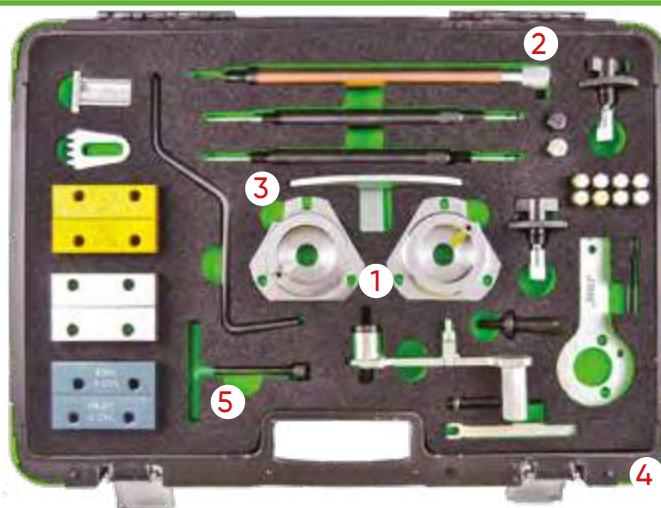

MARCAS	FIAT
HERRAMIENTAS OEM	1 860 874 000 (1), 1 860 895 000 (2), 1 860 898 000 (3), 1 860 905 000 (4), 1 860 845 000 (3)
CÓDIGOS DE MOTOR	MOTORES GASOLINA: Fiat Brava, Bravo, Barchetta, Cargo, Coupe, Marea, Palio, Weekend, Punto, Multila, Stilo, Idea, Doble Twin Cam Engines - 1.2, 1.4, 1.6, 1.8, 1.6V MOTORES DIESEL: Fiat Brava, Bravo, Marea, Weekend, Palio, Punto, Multila, Doble, Ulysse, Ducato, Stilo JTD Diesel Engines - 1.9D/TD . 1.9JTD . 2.4TD/JTD.



## KIT DE CALADO FIAT 1.2 16V

**53306**

54,50€



gasolina



<b>MARCAS</b>	FIAT: Fiat 1.2L 16V, Fiat Punto / Brava / Bravo / Stilo
<b>HERRAMIENTAS OEM</b>	1860992000 (1) (2), 1871000900 (3), 1860987000 (4), 186985000 (5)
<b>CÓDIGOS DE MOTOR</b>	176 B9000, 182 B2.000, 188 A5.000

## KIT DE CALADO ALFA / OPEL / VAUXHALL 1.6 / 1.8 16V

**53307**

38,50€



gasolina

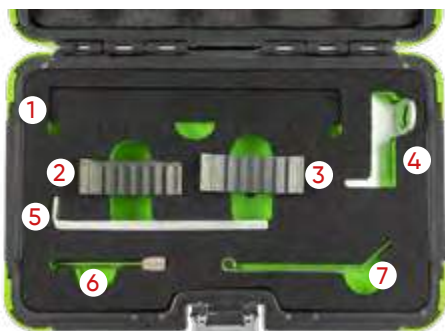

<b>MARCAS</b>	OPEL / VAUXHALL: Corsa-D, Agila, Astra-G-H, Meriva, Zafira-B, Vectra-C, Signum, Insignia	1.6, 1.8
	CHEVROLET: Aveo, Cruze, Orlando	1.4, 1.6, 1.8
	ALFA ROMEO: 159 FIAT: Croma	1.8
<b>HERRAMIENTAS OEM</b>	E10290 (1), 23056-06 (2) (3), E10230 (4), 23164-04 (5), 23174-01 (6), 23056-05 (7)	
<b>CÓDIGOS DE MOTOR</b>	Opel / Vauxhall: Z16LEL, Z16LER, Z16LET, Z16XE1, Z16XEP, Z16XER, A16XER, 18XER, A18XER, 2HO/A18XEL. Chevrolet: G14D, LDD, LXV (F16D4), 2HO(Z18XER). Alfa / Fiat: 939A4.000.	

## KIT DE CALADO FIAT / OPEL / VAUXHALL 2.2 16V CADENA

**53316**

31,50€

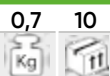

gasolina



<b>MARCAS</b>	OPEL: Astra-G (2000-2006), Astra-H (2006-2011), Signum (2003-2008), Vectra-B (2000-2002, Vectra-C (2002-2008), Zafira-A (2000-2005), Zafira-B (2005-2012), Speedster (2000-2006). VAUXHALL: VX220 (2000-2006). FIAT: Croma (2005-2009).
<b>CÓDIGOS DE MOTOR</b>	VAUXHALL / OPEL: Z22SE, Z22YH FIAT: 194A1.000.

## KIT DE CALADO FIAT / IVECO 2.3 / 3.0 JTD

**53319**

15,00€



diesel



<b>MARCAS</b>	FIAT: 2.3 / 3.0 JTD. IVECO: Daily.
<b>HERRAMIENTAS OEM</b>	99360614, 1 860 617 000, 99360615, 2 000 018 200.
<b>CÓDIGOS DE MOTOR</b>	F1AE0481C, F1AE0481D, F1AE0481N, F1CE0481A/D.

OPEL - VAUXHALL

## KIT DE CALADO CITROEN / PEUGEOT 1.0/1.2 VTI

**53876**

63,50€

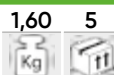

gasolina



<b>MARCAS</b>	CITROEN: C3 (III) PEUGEOT: 208, 308, 2008 SUV (2012-2014)
<b>HERRAMIENTAS OEM</b>	0109-2A (1), 0109-2B (2)
<b>CÓDIGOS DE MOTOR</b>	1.0/1.2 VTI EBO, (ZMZ), EB2, (HMZ)

## KIT DE CALADO CITROËN / PEUGEOT

53313

139,00€



diesel gasolina

### MARCAS

CITROËN: AX, BX, Boxer, Berlingo, C25, Dispatch, Evasion, J5, Jumpy, Jumper, Relay, Saxo, Synergie, Visa, XM, Xsara, Xantia, XZ, ZX.  
PEUGEOT: 106, 205, 206, 305, 306, 307, 309, 405, 406, 605, 607, 806, Expert, Partner, Solara, Talbot.

### HERRAMIENTAS OEM

7099TM (1), 0188X (2), 0188P (3), 0189AZ (4), 0188H (5), 0132AJ1 (6), 0189A (7), 0188PM (8), 21-260 (9), 4527-TS1 (10), M8X70 (11), 0188K (12), 0188J (13), 0132Q (14), 4507-TL (15), 4507-TJ (16), 9044-T (17), 4507-TJ (18), 5711-TA (19), 7014-TJ (20), 7017-TR (21), 0188X (22), 7017-TW (23), 7014-TM (24), 0189L (25)

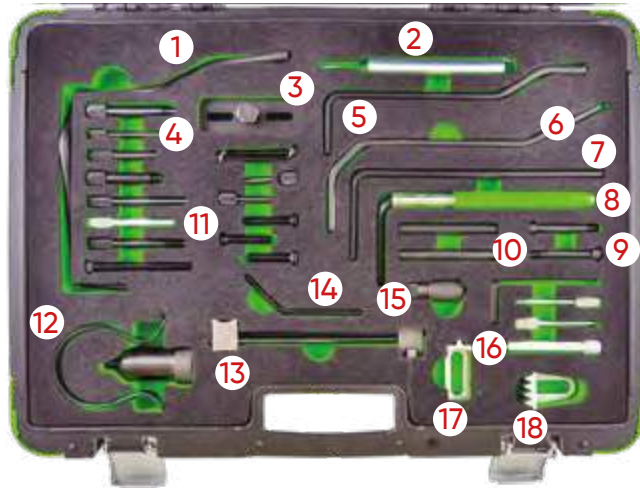

## KIT DE CALADO CITROËN / PEUGEOT 1.8 / 2.0

53314

97,50€



gasolina

### MARCAS

CITROËN: C4 Picasso/Grand Picasso (06-10), C5 II (04-08), C8 (05-10), Dispatch/Jumpy (07-11), Xsara 2.0 16v, C5 1.8/2.0/HPI, Xsara Picasso 1.8/2.0 16v (02-05).  
PEUGEOT: 406 1.8 16v (00-04), 407 (06-10), 807 2.0 16v (02-05).

### HERRAMIENTAS OEM

0189S2 (1), 0188J (2), 0188J2 (2), 0189S1 (3), 21-260 (4), 0189B (5), 0188M (6), 0188AH (7), 0189R (8)

### CÓDIGOS DE MOTOR

1.8 16v: EW7A(6FY).  
2.0 16v: EW10A(RFJ), EW10ABE4(RFH), EW10J4S (RFK).



## KIT DE CALADO ALFA ROMEO

53308

52,50€



gasolina

### MARCAS

ALFA ROMEO: 145,146,147,155,156, 1.4 1.6 1.8 2.0 TS, 1.4/1.6 16v; 145/146/147/155/156 (96-10), 1.8 16v; 145/146, (96-01), 155/156 (96-06), Spider/GTV (98-05), 2.0 16v; 145/146 (96-01), 147 (01-10), 155/156 (95-02), 166 (98-07), Spider/GTV (96-05), Púrpura / Purple: 1.4, 1.6 // Azul / Blue: 1.8, 2.0

### HERRAMIENTAS OEM

1822149000 (1), 1822154000 (2), 1825041000 (3), 1825042000 (4)

### CÓDIGOS DE MOTOR

Z1.4/1.6-321.02, 321.03, 321.04, 335.03, 676.01  
1.8/2.0-323.01, 672.04, 162.01, 323.10, 671.06, 322.01, 671.02, 322.05, 341.03, 363.01.

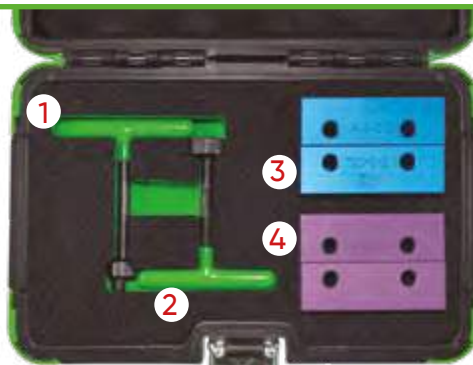

## KIT DE CALADO ALFA / FIAT / LANCIA 1.4 / 1.6 / 1.8 / 2.0 16V

53309

262,50€



gasolina



### MARCAS

ALFA ROMEO: 145,146,147,155,156, 1.4 1.6 1.8 2.0 TS, 1.4/1.6 16v; 145/146/147/155/156 (96-10), 1.8 16v; 145/146, (96-01), 155/156 (96-06), Spider/GTV (98-05), 2.0 16v; 145/146 (96-01), 147 (01-10), 155/156 (95-02), 166 (98-07), Spider/GTV (96-05), Púrpura: 1.4, 1.6 // Azul: 1.8, 2.0  
FIAT: Barchetta (96-00), Brava (95-00), Bravo (95-00), Coupe (96-01), Marea (96-00), Marea Weekend (96-00), Punto/Punto Classic (99-06), Stilo (01-08)  
LANCIA: Deada (95-99), Delta (96-99), Kappa (98-02), Lybra (99-06).

### CÓDIGOS DE MOTOR

1.4 16v: 335.03  
1.6 16v: 321.02, 321.03, 321.04, 372.03, 676.01  
1.8 16v: 322.01, 322.05, 671.06, 182A2.000, 183A1.000, 183A6.000, 188A6.000, 192A4.000  
2.0 16v: 162.01, 323.01, 323.1, 341.03, 363.01, 672.04  
2.0 20v: 175A3.000, 182A1.000, 182B7.000, 185A8.000.



## KIT DE CALADO ALFA / FIAT / LANCIA

53310

10,7 2 40

gasolina

455,00€



<b>MARCAS</b>	ALFA FIAT LANCIA	Alla, Barchetta, Bravo, Brava, Coupe, Delta, De- dra, Punto, Spider, GT
<b>HERRAMIENTAS OEM</b>	1860845000 (1), 1822154000 (2), 1860905000 (3), 1860992000 (4), 1860895000 (5), 1860874000 (6), 1860985000 (7), KM571A (8), 1860 896 000 (9), 0153A (10)	
<b>CÓDIGOS DE MOTOR</b>	1.2 / 16V, 1.4 / 12V, 1.6 / 16V, 1.6 eco, 1.8, 2.0 / 16V, 2.0 / 20V, 2.4 / 20V, 3.0 / V6.	



## KIT DE CALADO FIAT / ALFA / FORD

53312

2,6 5

gasolina

127,00€

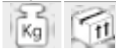

<b>MARCAS</b>	FIAT: New 500 (07-09), Idea (04-09), Linea (07-09), Gran- de Punto (07-09), Doblo 1 Cargo (05-09), Panda EV02 (05) FORD: KA 1.2 Duratec (09) ALFA ROMEO	
<b>HERRAMIENTAS OEM</b>	1860 987 000 (1), 2 000 004 400 (2), 2 000 015 800 (3), 2 000 004 300 (4), 2 000 004 500 (5)	
<b>CÓDIGOS DE MOTOR</b>	1.2: 169A4.000 / 199A4.000 . 1.4: 350A 1.000 / 188A4.000-EV02.	

## KIT DE CALADO RENAULT / NISSAN / OPEL / VAUXHALL 2.0 / 2.3 DCI / CDTI M9R / M9T

53311

2,15 5 135

diesel

97,00€



<b>MARCAS</b>	NISSAN: Primastar X83 (06-15), Qashqai/Qashqai+2 J10 (07-14), X-Trail T31 (07-14). VAUXHALL/OPEL: Movano-B (10-17), Vivaro (06-15). RENAULT: Espace/Grand Espace IV (06-10), Koleos (08-15), Laguna II (05-07), Laguna III (07-14), Master III (10-15), Megane II (06-10), Scenic/Grand Scenic II (06-09), Scenic/Grand Scenic III (09-15), Traffic II (06-14), Vel Satis (05-10)
<b>HERRAMIENTAS OEM</b>	Mot1769 (1), EN-48334 (2), Mot1766 (3), EN-48330 (3), KM-6130 (4), EN-48332 (5), Mot1773 (6), EN-48831 (6)
<b>CÓDIGOS DE MOTOR</b>	2.0D dCi M9R: 630, 780, 782, 784, 786, 788, 830, 832, 833, 834, 835, 836, 838, 855, 856. 2.0D CDTi M9R: 630, 780, 782, 784, 786. 2.3 Bi-CDTi: LP6/M9T706, LW7/M9T706. 2.3D dCi M9T: 670, 672, 676, 678, 680, 686, 690, 692, 694, 698.

# KIT DE CALADO FORD / SEAT / VOLKSWAGEN / MAZDA / VOLVO

53770

190,50€



diesel

gasolina

## MARCAS

**FORD:** Fiesta, Fusion, Courier, Escort, Focus, Focus C Max, Puma, Mondeo, Sierra, Cougar, Galaxy, C-Max, Orion, Tourneo Connect, Transit, Transit Connect.  
**VW:** Sharan.  
**SEAT:** Alhambra.  
**MAZDA:** 121.  
**VOLVO:** S40, V50.

## HERRAMIENTAS OEM

303-1061 (1), 303-1054 (2), 23-059 / 310-085 (3), 21-105 (4), 323-029 (6), 0194-B / 21-263 / 303-735 / 49 JE 02 021 (7), 0132-AB / 0178-D / 21-151 (9), 0194-C, 21-262, 303-734, 49 JE 02 020 (10), 21-238 / 303-679A / 303-1151 (11), 21-238 / 303-679A / 303-1151 (12), 303-1054 (13), 303-1151 (14), 21-238 / 303-679A (15), 303-393 / 303-393-02 (16), 303-1097 (17), 21-168 / 303-393 (18), 303-0985 (20), 2064 / 23-047 / 310-055 / U20003 (21), 303-652 (22), 21-229, 303-651 (23), 303-748 (24), 21-210 (25), 21-260, 303-732 (26), 21-163, 303-620 (27), 21-234 / 21-251 (28), 303-675 / 303-698 (29), 21-104 / 303-193 (30) / 21-162B / 303-367 / 303-376 (31), 21-162B / 303-376 / 303-376B (32), 23-019 (33), 23-058 / 310-084 (34), 0153-M / 0178-C / 0178-D (35), 0178-B / 5711-TB (36), 21-123 (37), 23-020 (38), 21-234 / 21-251 (39), 303-1059 (40), 23-019 (41), 303-1060 (42), 303-393 / 303-393-01 (43)

## CÓDIGOS DE MOTOR

FUJA, FUJB, FXJA, FXJB, FXJB, FYJA, FYJB, F8JA, F8JB, M7JA, M7JB, DHA, DHB, DHC, DHD, DHE, DHF, DHG, FHA, FHE, LIT, LIV, LIE, LIG, LIH, LJK, RDA, RDB, RKC, RQB, RQC, FXDA/C, FXDB/D, FYDA/C, FYDB/D, FYDH, HWDIAZ, AHU, AVG, AFN, D24, D24T, D24TIC, RFN, RTJ, RTK, RVA, RFK, RKD, B416A3, DV4TD (8HW/8HX/8HZ), DV4TED4 (8HV/8HY), DV6ATED4 (9HX/9HY/9HZ) F6JA, F6JB, F6JC, G8DA, G8DB, KKDA, SNJA, SNJB, STJA, STJB, ASDA, ASDB, FXJC, SPJA, SPJC, FYJC, HWDA, HWDB, SHDA, SHDB, SHDC, JQDA, LQDB, JTDA, JTDB, HXDA, HXJA, HXJB, IQDA/B, IQDB, PNBA, PNDA, RHBA, RHBA, SIDA, F6JD, TZJA, TZJB, HHDA, HHDB, HHJA, HHJC, HHJD, HHJE, HHJF, RTA, RTB, RTC, RTD, RTG, RTE, RTF, RTH, RTJ, RTK, RFN, BHPA, HCPA, HCPB, KKDA, P7PA, P9PA, P9PB, R2PA, R3PA, RWPA, RWPC, F9DA/B, FFBA, FFWA, KHBA, QYBA, QYWA, KKDB, C9DC, RVA, IZ, AFN, AHU, ANU, AUJ, G6DA, G6DB, G6DC, G6DD, G6DE, G6DF, G6DG, UFDB, TXDB, TYDA, UKDB, QXBA, AZBA, KLBA, QXBB, LPBA, AZBC, TYBA, UKBA, UFBA, TXBA, IXDA, QXWA, QXWB, AZWA, KLWA, AZWC, TYWA, UKWA, TXWA, UFWA, UFDA, TXDA, UKDA, Q4BA, KNBA, 4BA, 4BB, 4BC, 4CC, 4FA, 4CA, 4CB, 4DA, 4EA, 4FA, 4FB, 4FC, 4FD, 4GA, 4HB, 4HC, 4EB, 4EC, 4ED, 4GA, 4GB, 4GC, 4GD, 4GE, 4GF, 4HA, 4HD, FMBA/B, D5BA, ABFA, D3FA, D6BA, HJBA/B, F3FA, D2FA, D4FA, F4FA, F5FA, DOFA, QJBA, QJBB, QJBC, QJBD, FXFA, H9FA, H9FB, N7BA, N7BB, MZ-CD 1,6, Y6

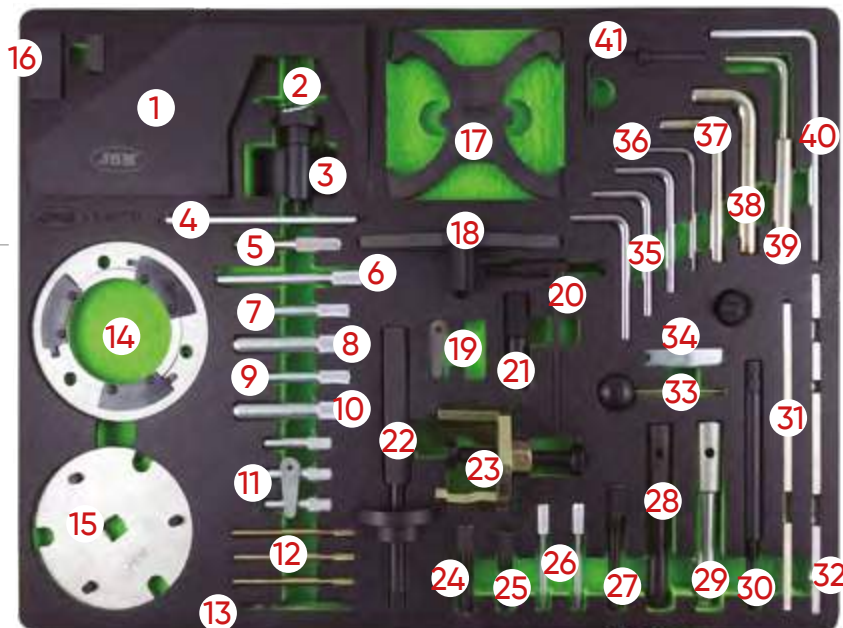

# KIT DE CALADO OPEL / CHEVROLET / SAAB / FIAT / LANCIA / SUZUKI / FORD

53774

189,50€



diesel

gasolina

## MARCAS

**ALFA:** 145, 146, 147, 156, 159, 166, GT, Crosswagon Q4  
**FIAT:** Punto, Grande Punto, Bravo, Brava, Marea Weekend, Stilo, Doblo, Cargo, Multipla Idea, Panda  
**LANCIA:** Ypsilon, Musa, Lybra, Thesis  
**OPEL:** Corsa B/C, Combo, Tigra, Agila, Tigra B, Meriva, Astra F/G/H, Astravan, Speedster VX220, Zafira A/B, Vectra B/C, Signum, Omega B, Sintra, Frontera A/B, Astravan, Kadett, Ascona, Omega, Monterey, Antara, Cromax, Speedster VX220  
**SUZUKI:** Ignis, Swift, Wagon R+  
**FORD:** Ka  
**CHEVROLET & DAEWOO:** Epica, Captiva, Nubira, Lacetti, Evanda  
**SAAB:** 9-3, 9-5 (98-04)

## HERRAMIENTAS OEM

1860905000 / 1860905010 / EN-46788 (1), KM-6148 (2), KM-6148 (3), 1870900400 / 1871000200 (4), KM-954 (5), KM-J-43651 (6), 1860905000 / 1860905010 / EN-46788 (7), KM-852 (8), KM-853 (9), 1870900300 / 303-1468 (10), EN-46785 / KM-951 (11), KM-932 (12), 1860703000 (13), KM-955 (14), KM-6130 / KM-6349 / KM-6349 (15), KM-927 (16), EN-48245 (17), KM-933 (18), EN-46785 (19), 1860985000 / 1871000900 / EN-46781 (20), 1860985000 / 1871000900 / EN-46781 (21), EN-48246 (22), KM-929 (23), 1870896900 / EN-46789 (24), KM-952 (25), 21-162B / 303-376 / 303-376B (26), KM-933 (27)

## CÓDIGOS DE MOTOR

X14XE, Z14XE, X16SEJ, X16XE, X16XEL, Y16XE, Z16XE, Z16YNG, C18XEL, X18XE, X18XE1, Z18XE, Z18XEL, C20SEL, C20XE, X20XEV, Z20LEH, Z20LEL, Z20LER, Z20LET, X22SE, X22XE, Y22SE, Y22XE, Z22XE, D223L, X10XE, Z10XE, Z10XEP, X12XE, Z12XE, Z14XEP, X20DTL, X20DTH, X22DTH, Y22DTR, 169A1.000, 955A4.000, 350A3.000, 192B4.000, 198A2.000, 350A2.000, 955A3.000, 192A8.000, 198A6.000, 198A3.000, 199B1.000, 199B2.000, 199A2.000, 199A3.000, 199A9.000, 940A3.000, 188A3.000, 939A2.000, 188B2.000, 188A8.000, 188A9.000, 323.02, 371.01, 937A2.000, 182B4.000, 182B9.000, 188A2.000, 188A7.000, 192A9.000, 186A6.000, 186A8.000, 192A1.000, 192A3.000, 192B1.000, 192A5.000, 186A9.000, 939A1.000, 199A5.000, 223A7.000, 223A9.000, 342.02, 362.02, 841G.000, 841H.000, 841P.000, 939A3.000, 185A2.000, 185A6.000, Z13DT, Z13DTJ, Z13DTH, Z19DT, Z19DTH, Z19DTL, Z19DTL, X10XE, Z10XE, Z10XEP, Z12XE, Z14XEP, X16SZR, Z16SE, 4EC1/T, 4EC1, 4EE1/T, 4EE1, X17DT, Y17DT, Y17DTI, Y17DTL, 16DA, 17D, 17DR/X, 7DTL, X17DTL, 4JX1/4, JG2T, 4FC1/T, 4FD1, X20DTL, Y20DTL, D223L Z20DMH, Z20DM, RA420, Z20S1, 194A1.000, Z22SE, Z22YH



VARIOS



# KIT DE CALADO FIAT / ALFA / LANCIA / OPEL / SUZUKI / FORD

53773

293,00€



diesel gasolina

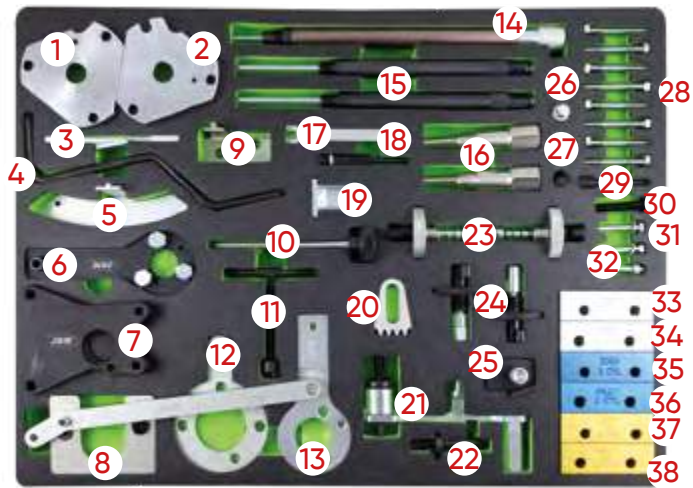

<b>MARCAS</b>	ALFA: Romeo 145, 146, 147, 155, 156, 159, 166, Spider, GTV, TS, GT, Crosswagon Q4 FIAT: Punto, Grande Punto, Brava, Bravo, Marea, Weekend, Stilo, Doblo, Cargo, Idea, Panda, Multipla, Palio, Stilo, 500 LANCIA: Lybra, Ypsilon, Thesis, Musa OPEL: Corsa, Agila, Meriva, Combo, Vectra, Zara, Astra, Insigna, Signum 19 CDTi SUZUKI: Ignis, Swift, Wagon R+ FORD: Ka
<b>HERRAMIENTAS OEM</b>	1860874000 (1), 1860874000 (2), 2000004400 / 2190754400 (3), 1860863000 (4), 1860898000 (5), 2190754500 (6), 2000004300 (7), 1870900400 (8), 1860703000 (9), 1860933000 (10), 1860845000 (11), 1870900300 (12), 1860905000 / EN-46788 (13), 1895443000 (14), 1860992000 (15), 1870896900 (16), 1860987000 (17), 1860905000 (18), 1860771000 (19), 1860161000 (20), 1860876000 (21), 1860876000 (22), 1871000900 (23), 1860985000 (24), 2000004200 / 2190754200 (25), 1860965000 (29)
<b>CÓDIGOS DE MOTOR</b>	176B9.000, 182B2.000, 188A5.000, 843A1.000, 323.02, 371.01, 182B4.000, 182B9.000, 186A6.000, 188A2.000, 188A7.000, 188B2.000, 192A1.000, 192A3.000, 937A2.000, 939A1.000, 192A5.000, 192B1.000, 198A5.000, 937A5.000, 939A2.000, 325.01, 342.02, 362.02, 185A6.000, 841C.000, 841G.000, 939A3.000, 940A3.000, 940A4.000, 940A5.000, Z19DT/DTH/DTR/DTJ/DTL, 169A1.000, 955A4.000, 350A3.000, 192B4.000, 198A2.000, 350A2.000, 955A3.000, 192A8.000, 198A6.000, 198A3.000, 199B1.000, 199B2.000, 199A2.000, 199A3.000, 199A9.000, 188A3.000, 188A8.000, 188A9.000, 192A9.000, 186A8.000, 186A9.000, 199A5.000, 223A7.000, 223A9.000, 841H.000, 841P.000, 185A2.000, Z13DT, Z13DTJ, Z13DTH, 182A4.000, 182A6.000, 182B6.000, 178B3.000, 186A3.000, 186A4.000, 350A1.000, 169A4.000, 188A4.000, 199A4.000, 199A7.000

# KIT DE CALADO FIAT / FORD / CITROËN / PEUGEOT

53771

154,50€



diesel gasolina

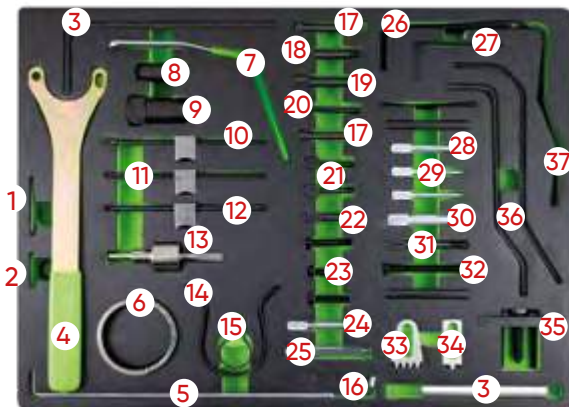

<b>MARCAS</b>	FIAT: Ulysse, Scudo, Ducato LANCIA: Zeta, Phedra FORD: Fiesta, Fusion, Focus, Focus C-Max CITROËN: C15, C1, C2, C3 Pluriel, C4, C4 Picasso, C5, C6, C8, DS3, DS4, DS5, Xantia, Xsara, Xsara Picasso, Evasion, Berlingo, Jumpy, Jumper, Saxo, ZX, XM, Evasion, AX PEUGEOT: 107, 1007, 206 cc, 207, 208, 306, 307 cc, 308, 406, 407, 508, 607, 806, 807, Partner, Expert, Boxer, 206, 106, 605, 205, 405
<b>HERRAMIENTAS OEM</b>	4200-TH (1), 0117-AR (2), 0188-X (3), 0606-A1A2 (4), 0188-Q2 (5), 0189-S1 (6), 7017-TR (7), 0132-P / 4507-TL (8), 0189-C (9), 0188-J1 (10), 0188-J2 (11), 0178-E (12), 0189-R (13), 0132-AK / 0188-AK / 0189-K / 0153-AK / 4533-TAD / MOT 1436 (14), 0188-AH (15), 0189-S2 (16), 0153-AB / 9041-TZ (17), 0153-M / 0178-C / 0178-D / 7014-TM / 9767-94 (18), 0189-A (19), 4527-TS1 (20), 0153-AB / 9041-TZ (21), 0189-B / 21-163 (22), 0132-AJ1 / 0153-G / 0188-M / 0189-J / 4533-TAC1 / 5711-TA (24), 0189-L (25), 0188-D / 7017-TM (26), 0132-X / 0188-Q1 / 4507-TJ / 9767-89 (27), 0194-B (28), 0132-AB / 0194-A (29), 0194-C / 21-262 / 303-734 (30), 4527-TS2 (31), 0188-E (32), 0153-A / 6012-T / 9765-54 (33), 0134-AF / 0134-Q / 0188-F / 9004-T (34), 0188-P2 / 0188-P / 174 / 7015-T (35), 0153-U 7019-T (36), 0153-N / 0188-Y / 7014-TJ / 7099-TM / 9797-34 (37)
<b>CÓDIGOS DE MOTOR</b>	F6JA, F6JB, F6JC, G8DA, G8DB, HHDA, HHDB, HHJA, HHJB Citroën_Peugeot: 1.0 / 1.1 / 1.4 / 1.6 / 1.6 16V, 1.4 / 1.6 HDI / 1.8 / 1.8 16V / 2.0 / 2.0 Turbo, 1.9D / 2.0HDI / 2.2HDI / 1.8 16V / 2.0 16V TU9 (CDY/CDZ), TU1 (HDY/HDZ/HFX/HFY/HFZ), TU3 (KDX/KDY/KDZ/KFX/KFZ), TU5JP4 (NFU/NFX), TU5 (BDY/BFZ/NFT/NFV/NFW/NFY/NFZ), XU7 (LFW/LFX/LFZ), EW7J4 (RLZ), XU7JP4 (LGY), XU10 (RFL/RFU/RFW/RFX/RGX/RGY), XU10JP4 (RGX/RGY), EW10A (RFJ), EW10J4S (RFK), EW10D (RLZ), EW12J4 (3FZ), ET3JE (KFU), TU3A/JP (KVF/KFW), DV4TD (8HW/8HX/8HZ), DV4TED4 (8HV/8HY), DV6A-TED4 (9HX/9HY/9HZ), EW10-CVI (RLZ), EW12 (3FZ), DW8 (WJZ/WJY), DW10 (RHY/RHV/RHZ/RHS/RHM/RHW/RHT/RHR/RHX), DW12 (4HX/4HZ/4HW/4HY), EW7J4 (6FZ), EW10J4 (RFR), EW10J4D (RLZ), DW12TED4 (4HW), DW10ATED (RHT/RHV/RHW/RHX/RHZ) Ford 1.4 / 1.6 Duratec TDCI

# KIT DE CALADO FORD / VAG / MAZDA / VOLVO

53772

211,00€



diesel gasolina

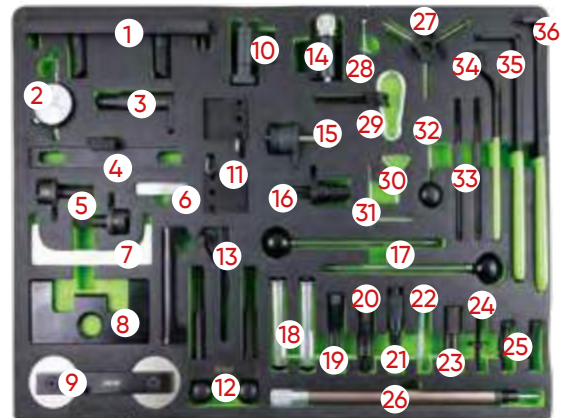

<b>MARCAS</b>	AUDI: 80, A1, A2, A3, S3, A4, A5, A6, TT, Q5 SEAT: Arosa, Ibiza, Cordoba, Leon, Toledo, Alhambra, Altea, Inca (99-04) SKODA: Fabia, Octavia, Superb VW: Lupo, Polo, Fox, Golf, Bora, Jetta, Golf Plus, Passat, Beetle, Touran, Sharan, Caddy, Caddy Maxi, Transporter, Golf VI Cabrio, Tiguan FORD: Galaxy
<b>HERRAMIENTAS OEM</b>	T10252 (1), VAS6079 (2), T10121 (3), MP1-1312 / T10098 / T20038 / T20038 (4), T10123 (5), 23-058 / 310-084 / T10008 (6), 2065A / T10008 / U40021 (7), 3418 (8), T10171 (9), 23-059 / 23-059 / 310-085 / T10050 / T10050 (10), 3458 / T30094 (11), T10016 / T10074 / T10074 (12), T10100 (14), T10414 (15), 3366 / T20018 / T20044 (16), 3411 (17), 3369 / T30092 (18), T10341 (19), 3242 / T40069 / T30052 (20), T40026 (21), 3359 / MP1-301 / T20102 (22), 2064 / U20003 (23), T10120 (24), MP1-1312 / T10098 / T20038 (25), T10170 (26), T00115 / T10264 / T40098 (27), T10092 (28), T00115 / T10264 / T40098 (29), 303-1054 / T10115 (30), T10060 / T10060A (31), 3359 / MP1-301 / T20102 (32), T10340 (33), 2587 (34), 3387 / U30009A (35), 3387 / T10020 (36)
<b>CÓDIGOS DE MOTOR</b>	ARC, ATN, AUS, AVY, AZD, AFH, BCA, AJV, AKQ, AUA, AUB, AXP, AFH, AFN, AFK, AHW, AHU, APE, AQQ, AUS, AXP, AZD, BBY, BBZ, BCB, ANY, AYZ, AMF, ATL, BAY, BHC, BMS, BNM, BNV, BWW, AJM, AMG, ANU, ARL, ASZ, ATD, ATJ, AUY, AVB, AVF, AVQ, AVX, AXB, AXC, AXR, BEW, BJB, BKC, BKE, BLS, BLT, BMT, BPX, BRB, BRM, BRP, BRS, BRU, BSU, BSW, BTB, BUK, BVK, BXE, BFX, BDJ, BDK, BGW, BHW, BKD, BKP, BLB, BMA, BMM, BMN, BMP, BMR, BNA, BPW, BRC, BRE, BRF, BRU, BUZ, BE, BVF, BVG, BVH, BWK, BTS, BMY, BLF, BWV, AZV, BKD, AWY, AZQ (55 - 64 PF), AXU, BAG, BKG, BLF, BLN, BLP, BFV, BKF, BNU, BVP, BVR, IZ, CBZA, CBZC, CBZB, CAXA, CAGA, CAGB, CAGC, CAHA, CAYA, CAYB, CAYC, CBAA, CBAB, CBAC, CBBA, CBBB, CBDB, CBDD, CBDC, CBEA, CEGA, CKUB, AZV, BDJ, BHP, BKD, BLB, BMA, BMM, BMN, BMP, BMR, BNA, BPW, BRC, BRE, BRP, BRT, BSS, BUJ, BUZ, BVA, BVE, BVF, BVH, BVW, ACV, ACV, AFB, AGX, AHD, AHY, AHY, AJT, AKE, ANJ, APA, AUF, AXG, AXG, AXL, AYC, AYM, AYY, BAU, BBE, BBF, BCZ, BDG, BDH, BFC, BJJ, BJK, BJL, BJM

# KIT DE CALADO VOLVO 3.0 / 3.2T6 FREELANDER2 3.2I

**53315**

262,50€



gasolina



**MARCAS**

**VOLVO:** S60 (10-16), S80 (07-15), XC60 (08-15), XC70 (06-15), XC90 (10-14), V60 (10-15), V70 (10-15).  
**LAND ROVER:** Freelanders II (11-14).

**HERRAMIENTAS OEM**

**VOLVO:** 999-7263 (3), 999-7264 (1), 999-7272 (5), 999-7257 (2), 999-7261 (4).  
**LAND ROVER:** 303-1225 (3), 303-1226 (1), 303-1219 (2), 303-1223 (4).

**CÓDIGOS DE MOTOR**

**3.0 Turbo:** B6304T2, B6304T4.  
**3.2:** B6324S, B6324S5.  
**3.2i:** B6324S.

## CONJUNTO DE 6 MÓDULOS DE KITS DE CALADO

**53775**

1.108,50€

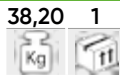

diesel gasolina

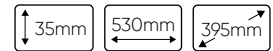

**53769**

RENAULT / NISSAN / OPEL / VOLVO



**53770**

FORD / SEAT / VOLKSWAGEN / MAZDA / VOLVO



**53771**

FIAT / FORD / CITROËN / PEUGEOT



**53772**

FORD / VAG / MAZDA / VOLVO



**53773**

FIAT / ALFA / LANCIA / OPEL / SUZUKI / FORD



**53774**

OPEL / CHEVROLET / SAAB / FIAT / LANCIA / SUZUKI / FORD



VARIOS

## CARRO DE HERRAMIENTAS 7 CAJONES ESPECIAL KITS DE CALADO

**53951**

1.794,00€



**53952**

1.794,00€



**53775**

1.108,50€

diesel

gasolina

### SET DE 6 MÓDULOS DE KITS DE CALADO



**53769**



**53770**



**53771**



**53772**



**53773**



**53774**





## LLAVE UNIVERSAL PARA ÁRBOL DE LEVAS + ADAPTADORES

51340

38,00€

2,15 6 200



- Contiene:  
1 Llave con rango de apertura: 40mm mín - 235mm máx. + Largo 540mm.  
4 juegos de 2 tornillos adaptadores de 4 medidas.  
1 juego de 2 roscas de 1cm. de diámetro.



## EXTRACTOR DE POLEA DE ÁRBOL DE LEVAS FORD

53318

24,00€

0,4 20



diesel



MARCAS FORD

APLICABLE A MOTORES F8M, F8Q, S8U, S9U.

## VASOS DE AJUSTE DEL ÁRBOL DE LEVAS VAG 1.8 / 2.0 TFSI

53323

9,50€

0,15 18 36



gasolina



MARCAS AUDI: A3, A4, A5, Q5 1.8.  
VW: 2.0 cadena.

HERRAMIENTAS OEM T10352, T10352/1.

CÓDIGOS DE MOTOR 1.8 / 2.0

## HERRAMIENTA DE BLOQUEO DEL ÁRBOL DE LEVAS GRUPO VAG

53320

12,00€

0,15 10 40



diesel

MARCAS SEAT: Alhambra, Altea, Arosa, Cordoba, Ibiza, Leon, Toledo 1.4/1.9/2.0 TDI.  
VW: Passat 1.9.  
AUDI: A4/A6 1.9.

HERRAMIENTAS OEM T10008, T20102, T10100.



## ÚTIL DE CALADO DE DISTRIBUCIÓN VAG

52271

18,00€

0,43 5 40 320



MARCAS

AUDI: A2 1.4TDI (02-06), A3 1.9 2.0TDI (02-08), A4 1.6TDI (02-05), A4 1.9 2.0TDI (04-08), A6 1.9TDI (02-05).  
SEAT: Altea 1.9SDI/TDI (05-08), Leon 1.9 2.0TDI (05-08), Toledo 1.9SDI/TDI (05-08).  
SKODA: Fabia 1.4TDI (03-06), Octavia II 2.0TDI (03-06)  
VW: Beetle 1.9TDI (02-08), Bora 1.9TDI (02-08), Fox 1.4TDI (02-08), Golf 1.9 2.0TDI (02-08), Lupo 1.4TDI (02-08), Polo 1.4, 1.9TDI (02-08), Sharan 1.9TDI (02-08).

CÓDIGOS DE MOTOR

AUDI: AMF, ASZ, ATD, AVB, AVF, AWX, AXR, AZV, BHC, BKC, BKD, BKE, BLB, BMN, BNA, BPW, BRB, BR, BRD, BRE, BRF, BUY, BVA, BVF, BVG.  
SEAT: BJB, BKC, BLS, BMM, BXE  
SKODA: AMF, AZV, BKD  
VW: AJM, AMF, ANU, ARL, ASZ, ATD, AUY, AVB, AVF, AWX, AXR, BAY, BMS, BNM, BNV, BVWB

## SET DE BLOQUEO DEL ÁRBOL DE LEVAS

51489

12,00€

0,35 10 40 2.250



gasolina



- Motores de árbol de levas doble.

MARCAS

VW: Lupo 99, Polo 95, Caddy 96, Polo Classic, Variant 96, Beetle 1.4L 99, Golf 1.4L, 1.6L 98 y 1.4L, Bora, 1.6L 99.  
AUDI: A2.

HERRAMIENTAS OEM

T10016.

CÓDIGOS DE MOTOR

1.4 / 1.6 16V



## BLOQUEADOR DE CIGUEÑAL LEVA PARA RENAULT / NISSAN / DACIA / SUZUKI

51488

16,00€

0,25 5 100 2.250



- Pasadores de seguridad para el conjunto de árbol de levas y el cigueñal para Renault motores diesel y de gasolina.  
- Conveniente para el bloqueo del motor durante el cambio o mantenimiento del conjunto del árbol de levas.

MARCAS

RENAULT: Captur, Clio II,III,IV, Espace/Grand Espace III,IV, Fluence, Kadjar, Kangoo, Laguna I,II,III, Logan/Logan MCV, Megane I,II,III,IV, Modus/Grand Modus, Scenic/Grand Scenic I,II,III,IV, Twing II, Trafic II, Master II 1.5dCi & 1.9 dCi.  
DACIA: Dokker, Duster, Lodgy, Logan, Sandero 1.5dCi  
NISSAN: Almera, Cube, Juke, Kubistar, Micra, Note, NV200/Evalia, Primera, Tiida, Interstar, Primastar 1.5dCi & 1.9 dCi  
SUZUKI: Grand Vitara, Jimny 1.5DDiS & 1.9DDiS

CÓDIGOS DE HERRAMIENTAS

MOT1489, MOT1430, MOT1054.

CÓDIGOS DE MOTOR

K9K, F8Q, F9Q - Gasolina, Clio, R19, Laguna 1.8/2.0 Motor de códigos: F3R F3P



## EXTRACTOR/INSTALADOR DE RETENES DE CIGÜEÑAL (GRUPO VAG)

**53875** 1,85 4  
125,00€   





**MARCAS** VW: Golf, Touran  
AUDI: A3, A4

**HERRAMIENTAS OEM** OEM T10134.

**CÓDIGOS DE MOTOR** 1.4i turbo  
1.4, 1.6 inyección directa de gasolina  
1.9, 2.0 SDI  
2.0 diesel common rail

## DESMONTADOR Y TENSOR DE CORREAS EN POLY-V





**51927** 0,65 5 640  
25,00€   



- Para montar-desmontar y extraer la nuevas correas en POLY-V fácilmente.  
- Adecuado para el PSA y los motores de Ford Fiesta 1.4/1.6, Citroën C4, Peugeot 307, Fiat Doblo, Dacia Logan.  
- Herramienta indispensable para uso profesional.  
- Sin un punto de agarre preciso, no es posible desmontar y extraer las correas adecuadas para este utillaje.



## TENSÍOMETRO PARA CORREAS DE DISTRIBUCIÓN

**52616** 0,35 10 40 800  
42,00€    

- Dos escalas graduables (daN) con lectura frontal y posterior.



## HERRAMIENTA DE SINCRONIZACIÓN DE POLEAS VW / AUDI 2.5TDI 35MM

**53325** 0,1 20 100 gasolina  
7,50€   



**MARCAS** AUDI: 100 ('91-), A6 (2.5 TDI) 2.3, 2.4, 2.5, 2.8, 2.9D TDI (1991-2003)  
VW: LT, Transporter

**CÓDIGOS DE MOTOR** AAB, AAT, ACU, ACV, AEL, AET, AGX, AHG, AHY, AJA, AJT, ANJ, APA, APL, AUF, AVT, AXG, AXL, AYC.

**HERRAMIENTAS OEM** 3355

## HERRAMIENTA AJUSTE TENSIÓN CORREA VAG



**53321** 0,25 10 50 gasolina  
10,50€   



**MARCAS** AUDI: A4/1.8T, 2.0 1999-2004 A6/1.8T 2002-2004 A4/3.0 (2002 - ), A6/3.0 (2002 - ), A8/7.0 (2003 - ).  
VW: Golf Passat 2.0 TDI DIESEL, Golf 88-97, Passat 92-97, VW T4/2.0 1992-2004.

**HERRAMIENTAS OEM** T10020.

## HERRAMIENTA RETENCIÓN BOMBA ANTICONGELANTE

**53317** 0,64 12 diesel  
32,00€  

- Utilizado para dejar el motor en posición alineada durante la sustitución de la bomba de agua.  
- Permite reemplazar la bomba sin modificar la posición de la cadena de distribución.

**MARCAS** OPEL 2.2 Cadena  
VAUXHALL 2.2 Cadena



## VAÑO DE 1/2" PARA LA TUERCA DE RETENCIÓN DE LA ANTECÁMARA DE COMBUSTIÓN

**52819** 0,24 5 50 1/2" MERCEDES  
22,00€   

58 DIENTES





PARA BIDONES



224

PARA UREA AUS32



247

BOMBAS SUMINISTRO



246

BOMBAS EXTRACCIÓN / LLENADO



248

RECOGEDORES DE ACEITE



249

PISTOLAS



252

RECOGEDORES



253

EMBUDOS



254



# ACCESORIOS LUBRICANTES



## CUBETO RETENCIÓN PARA BIDONES

Cubierta desmontable / Palet fijo para derrames / Quitar los bidones antes de utilizar una carretilla elevadora / Fácil transporte / Para usar con la mayoría de carretillas elevadoras y transpalets / Fabricado en polietileno (PE) 100% reciclable.

SOPORTA 400 KG

**52804**

337,50€



230L



1 BIDÓN VERTICAL

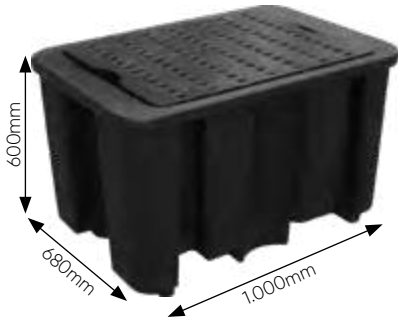

SOPORTA 650 KG

**52805**

422,50€



250L



2 BIDONES VERTICALES



NO APTO PARA TRANSPALETAS  
SOPORTA 1.250 KG

**52806**

739,00€



250L



4 BIDONES VERTICALES

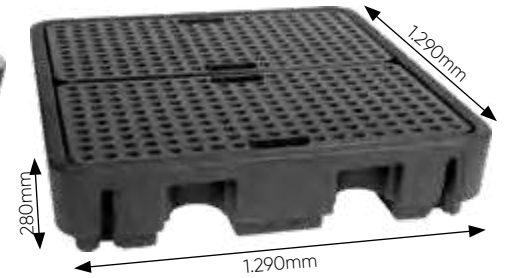

HOMOLOGADO  
DIBT

## CUBETO RETENCIÓN ESPECIAL EUROPALLET 2 BIDONES

**53214**

281,50€



- Para 2 bidones.
- Compatible con europallet (1200 mm x 800 mm) y paletas plásticas con dimensiones similares.
- Apilable para el transporte y el almacenaje económico.
- Se puede colocar la europaleta directamente encima del cubeto para reducir el coste.
- Las paletas cargadas pueden ser colocadas en/retiradas del cubeto con o sin la rejilla por carretilla elevadora.
- Cubeto con una altura baja idóneo para el trabajo.
- Capacidad en línea o por encima de las normas Europeas, Británicas y Americanas.
- Puede ser manipulado por carretilla elevadora de los 4 lados o transpaleta por 2 lados cuando está vacío.
- Fabricado en polietileno - 100% reciclable.



## CUBETO RETENCIÓN 1 CONTAINER IBC 1.000L

**52807**

1.540,00€



- Apilable, ahorra espacio, innovador.
- Altura baja (700mm) para facilitar su uso.
- Superficie de trabajo muy amplia (2,5 m<sup>2</sup>).
- Plataforma con acceso para las manos y agujeros para inspección y para inserción de bombas.
- Fácil transporte.
- Compatible con la mayoría de carretillas elevadoras y transpaletas.
- PE 100% reciclable resistente a los rayos UV.

SOPORTA 2.500 KG



HOMOLOGADO DIBT



## CARRO PORTA BIDONES ESPECIAL ACEITE

**50924**

- Apto para bidones de aceite de 200L.

**299,00€**

	31
	1
	7



RUEDA GIRATORIA

## PINZA PARA BIDONES (CAPACIDAD 500 KG.)

**53612**

4,75 1 50

**88,00€**

--	--	--

**500Kg**

- Para manejar bidones de aceite.
- Capacidad: 500kg.
- Tipo vertical de agarre del bidón.
- Especial bidones aceite 200L.



CE

## LLAVE PLÁSTICA PARA BIDÓN

**52452**

0,12 6 60 1.080

**8,00€**

--	--	--	--

- Material: Nylon.
- Antichispa y antipolvo.
- Relieves acabado de 3/4" y 2".
- Útil para bidones de 200L.

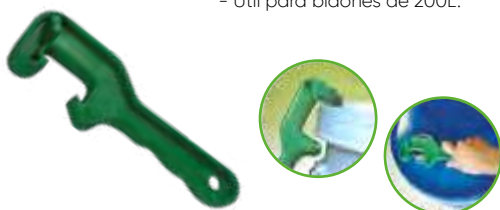

## GRIFO PARA BIDONES DE 200L

**53078**

0,25 5 25 300

**18,00€**

--	--	--	--



- Permite un vaciado rápido de bidones de 200L.
- Puede ser usado para agua, todo tipo de aceites y alcohol.
- Material: polietileno (PE).
- Junta en E PDM.
- Resorte en acero inoxidable.



## GRIFO PLÁSTICO PARA BIDÓN DE ACEITE 3/4" DE 200L

**53518**

0,05 10 500 3.000

**3,50€**

--	--	--	--

200L



- Válido para todos los líquidos.
- Rosca macho 3/4".

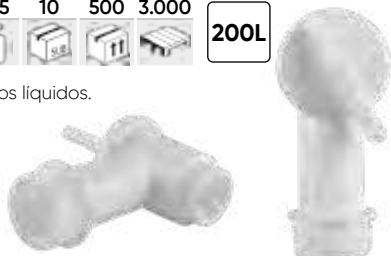

## GRIFO PARA BIDÓN ACEITE DE 3/4" PARA BIDONES DE 200L

**52453**

0,19 5 100 1.000

**19,00€**

--	--	--	--



200L

- Grifo de seguridad.
- Rosca de 3/4".
- Cuerpo de Aleación.
- Junta de Nylon.
- Aplicaciones: aceites, lubricantes, gasolina, diesel, queroseno, etc.
- Válido para Urea AUS32.



## ADAPTADOR ROSCA BOMBA-BIDÓN PLÁSTICO

**13982**

0,05 100

**4,00€**

--	--



- Permite ajustar y compensar las diferentes rosas de bidones, bombas y barriles.



## BOMBA MANUAL DE EXTRACCIÓN PLÁSTICA

**52329**

0,98 10 140

**34,50€**

--	--	--



- Para bidones de 25, 50 y 200L.
- 350ml por bombeo.
- Cuerpo y pistón de polipropileno.
- Mango de plástico ABS.
- Aplicaciones: Alcoholes, aceites, lubricantes, gasolina, diesel, queroseno, etc.
- Conducto de succión: Largo mínimo: 320mm. Largo máximo: 900mm.



320-900mm

## BOMBA SUMINISTRO GASOIL CON PISTOLA Y CONTADOR (200V-240V)

53697

14 1

369,50€

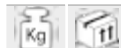

- Voltaje: 220V±10% 50HZ.
- Potencia: 550W.
- Caudal de entrega: 20-65 l/min.

- Longitud cable: 2m.
- Longitud manguera de succión: 2m.
- Longitud manguera de suministro: 4m.

CON PARO AUTOMÁTICO



BOMBA

14607

8,6 2

164,50€

Kg l



PISTOLA CON PARO AUTOMÁTICO

14606

0,98 20

57,00€

Kg l



CONTADOR DIESEL/ GASOLINA

14608

1,7 20

69,00€

Kg l



MANGUERA PARA EXTRACCION

14609

0,6 10

16,00€

Kg l



MANGUERA PARA SUMINISTRO

14610

2,4 5

36,50€

Kg l

## BOMBAS DE SUMINISTRO DE GASOIL CON PISTOLA

- Bombas de transferencia de combustible **portátil**.
- **Fácil de transportar**: tamaño compacto y con asa incorporada.
- Pistolas con **apagado automático**.



53610

13 2 28

242,50€



ELÉCTRICA

- Eléctrica.
- Se suministra con pistola y mangueras.
- Longitud de la manguera de entrada: 2m.
- Longitud de la manguera de salida: 4m.

CON PARO AUTOMÁTICO



BOMBA

14607

8,6 2

164,50€

Kg l

PISTOLA

14606

0,98 20

57,00€

Kg l

MANGUERA PARA EXTRACCION

14609

0,6 10

16,00€

Kg l

MANGUERA PARA SUMINISTRO

14610

2,4 5

36,50€

Kg l

53609

7,30 2 28

180,00€



CON PARO AUTOMÁTICO

- Longitud de la manguera de entrada: 2m.
- Longitud de la manguera de salida: 4m.

- Incorpora cable largo con pinzas que permite una fácil conexión con la batería del vehículo, ideal para aplicaciones agrícolas e industriales.
- Solución práctica para reabastecer y transferir combustible / diesel cuando solo hay batería disponible.
- Se suministra con pistola y mangueras.



BOMBA

15553

107,50€

PISTOLA

14606

0,98 20

57,00€

Kg l

MANGUERA PARA EXTRACCION

14609

0,6 10

16,00€

Kg l

MANGUERA PARA SUMINISTRO

14610

2,4 5

36,50€

Kg l



## DEPÓSITO PARA UREA AUS32 (75L)

53644

18,15 1 4  
Kg fl

948,00€

- Tanque de 75 litros móvil con una potente bomba de 12V capaz de suministrar hasta 10l/min, manguera y válvula de cierre automático.
- Las ruedas de gran diámetro (20mm) permiten maniobrar fácilmente en terrenos irregulares.

75L



POTENTE BOMBA DE 12V CAPAZ DE SUMINISTRAR 10 L/MIN

1.040mm 440mm 520mm

12V 75L 10 L/min  
40 PSI 2.75 bar 4m

FABRICADO EN POLIETILENO RESISTENTE A LOS GOLPES, A LA CORROSIÓN Y A LOS RAYOS UV

CABLE DE 4M



MANGUERA DE EPDM DE 4M



## CONTADOR DIGITAL PARA BOMBA DE SUMINISTRO

53699

0,3 20  
Kg fl

63,05€

- Pila incluida.
- Entrada: BSPT 1/2".
- Flujo: 1~50l/min.



DIESEL



## BOMBA ELÉCTRICA PARA UREA AUS32

53645

3,10 4 24  
Kg fl

199,00€

- Bomba eléctrica para bidones diseñada para medios a base de agua, Urea AUS32 y productos químicos selectos de bidones metálicos de 205L o 1000-1250L de IBCs.
- Construcción compacta y ligera.
- Fusible incorporado para protección de sobrecarga y motor silencioso.
- Filtro de acero inoxidable integrado en la entrada del tubo de succión que evita que los contaminantes entren y causen daños.



INTERRUPTOR ON/OFF CON INDICADOR LED

TUBO DE SUCCIÓN TELESCÓPICO EXTENSIBLE DE 850MM A 1.245MM

850-1246mm



PISTOLA

15123

32,00€

MANGUERA 4M

14473

46,00€

ADAPTADOR DE ENTRADA PARA DEPÓSITO IBC

14703

13,00€

2" BSP



IVA no incluido



www.jbmcamp.com

## BOMBA PARA BIDÓN DE ACEITE + MANGUERA CON GRIFO

**52601**

352,50€

9,1

2

30



200L

- Presión Ratio: 5:1.
- Entrada de Aire: 1/4".
- Salida de Aire: 1/4".
- Presión trabajo: 6-8 bar.
- Presión Máx.: 8 bar.
- Consumo de Aire: 250 L/min.
- Capacidad relativa 6 bar: 18 L/min.
- Temperatura del aceite: -10~50°C.
- Viscosidad máxima: 240 SAE.
- Largo del tubo: 950mm.



MANGUERA CON GRIFO PARA REF. 52601

**12056**

57,00€

1,71

61



## KIT DE BOMBA ACEITE + MANGUERA + PISTOLA ACEITE DIGITAL

**50935**

495,00€

10,7

1

20



200L

- Largo de la manguera: 2m.
- Largo del tubo: 950mm.
- Viscosidad máxima: 240 SAE.
- Capacidad relativa 6 bar: 18 L/min.
- Consumo de aire: 250 L/min.
- Temperatura del aceite: -10~50°C.
- Presión trabajo: 6-8 bar.
- Presión Ratio: 5:1.
- Entrada de Aire: 1/4".
- Salida de Aire: 1/2".
- Presión Máx.: 8 bar.

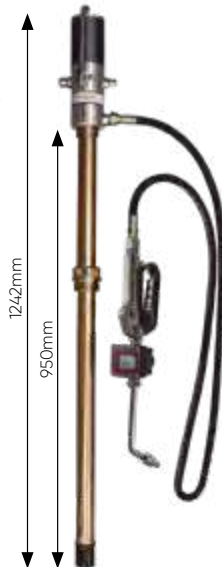

## BOMBA PARA BIDÓN DE ACEITE

**50918**

299,00€

7,25

1

34



200L

- Presión Ratio: 5:1.
- Entrada de Aire: 1/4".
- Salida de Aire: 1/2".
- Presión trabajo: 6-8 bar.
- Presión Máx.: 8 bar.
- Consumo de Aire: 250 L/min.
- Capacidad relativa 6 bar: 18 L/min.
- Temperatura del aceite: -10~50°C.
- Viscosidad máxima: 240 SAE.
- Largo del tubo: 950mm.

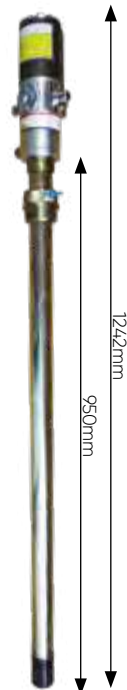

TUERCA DE BIDÓN PARA REF. 50935 Y 50918



**10767**

21,00€

0,28

90



**10925**

18,00€

0,67

90



## PISTOLA DE BOMBEO PARA ACEITE CON CAUDALÍMETRO DIGITAL

**50917**

228,00€

2,15

10

50



- Entrada de aire: 1/2".
- Rango de Caudal: 1-35 L/min.
- Presión trabajo: 6-8 bar.
- Rango de temperatura del aceite: -10~60°C.
- Viscosidad máxima: 240 SAE.
- Pila incluida.
- Peso: 1,4Kg.



## CARRO PORTA BIDONES ESPECIAL ACEITE

**50924**

299,00€

- Apto para bidones de aceite de 200L.

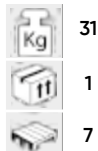

31

1

7



RUEDA GIRATORIA



## BOMBA MANUAL PARA EXTRACCIÓN DE ACEITE

**51253**

39,00€

465mm

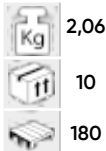

2,06

10

180

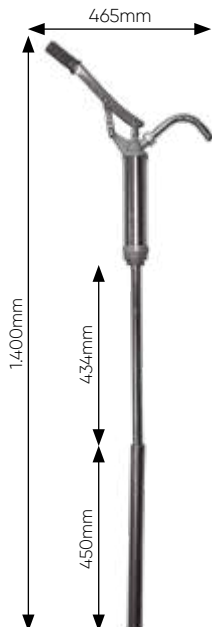

## ADAPTADOR ROSCA BOMBA-BIDÓN PLÁSTICO

**13982**

4,00€

0,05

100



- Permite ajustar y compensar las diferentes rosca de bidones, bombas y barriles.

## BOMBA MANUAL DE EXTRACCIÓN

**52428**

39,00€

1,39

1

10

120



- Para bidones entre 50 y 200L.
- Caudal: 400ml por impulso.
- Capacidad de bombeo: 32L x min.
- Adaptador de boca de 2" incluido.
- Tubería de succión de 101cm, con entrada de 1 1/4" y salida de 1".
- Aplicaciones: aceites, lubricantes, diésel, fluidos a base de petróleo.
- Recomendado para: líquido de freno, detergentes, glicerina, ácidos suaves, fluidos a base de petróleo.
- No permitido para: ácido fuertes, lejías, gasolina.



# RECOGEDOR DE ACEITE CON SISTEMA DE ASPIRACIÓN

**53874**

**398,00€**

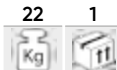

**90L**

**8-10 BAR**

## DESPIECE DISPONIBLE



Diseñado para recolectar y drenar aceite procedente del motor o engranajes del vehículo.

- Presión de trabajo: 8 ~ 10 bar.
- Nivel de vacío: 0 ~ 0.8 bar negativo.
- Capacidad del depósito: 70L.
- Capacidad del colador de recogida: 10L.
- Capacidad del vaso medidor: 10L.
- Velocidad de aspiración según diámetro de la varilla: 0.8L/min (Ø5x3.5mm); 1L/min (Ø6x4.5mm); 1.6 L/min (Ø8x6.5mm).
- Dimensiones: 43x49x163cm.
- Tipo combustible: aceite de motor y de engranaje.
- Temperatura recomendada de trabajo del aceite: 40 ~ 60°C.
- Sistema de aspiración.
- Sistema de medición ocular.
- Depósito de gran capacidad.
- Mango para facilitar manipulación
- Ruedas para facilitar el transporte.

REF.	CARACTERÍSTICAS	1	2	3	4	5	€
15018	Módulo eva juego de vasos para tapones cárter 22pcs	1,45	-	10	480		46,00€
14937	Rueda para recogedor de aceite 80l	0,30	-	14			9,50€
15282	Manómetro	0,20	-	20			15,00€
15283	Manguera (Para depósito plástico)	0,40	-	20			27,50€
15305	Manguera con grifo en forma de gancho	0,65	-	40			19,50€
15306	Manguera para conectar el embudo al depósito con válvula de cierre	0,35	-	20			27,50€
15307	Embudo para recogedor de aceite	2,10	-	10	40		39,55€
15310	Grifo parte superior para recogedor de aceite	0,05	-	20			11,50€
15311	Conjunto racords	0,20	-	20			11,50€
15312	Racord para conectar el depósito y la manguera	0,10	5	40			11,50€
15318	Tubo de conexión para recogedor de aceite	0,80	-	20			17,00€
15308	Rueda pequeña giratoria	0,35	-	40			7,00€
14014	Manguera recambio de 4mm	0,02	-	100			6,00€
14015	Manguera recambio de 6mm	0,05	-	100			6,00€
14016	Manguera recambio de 8mm	0,05	-	100			6,00€
15550	Tubo metálico de succión de 6mm	0,07	-	100			6,00€
15551	Tubo metálico de succión de 8mm	0,08	-	100			6,00€



# RECOGEDOR DE ACEITE

**53873**

**325,00€**

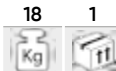

**80L**

**1-3 BAR**

## DESPIECE DISPONIBLE



Diseñado para recolectar y drenar aceite procedente del motor o engranajes del vehículo.

- Presión de trabajo: 1-3bar
- Capacidad del depósito: 70L
- Capacidad del colador de recogida: 10L
- Dimensiones 35x48x163cm
- Tipo combustible: aceite de motor y de engranaje.
- Depósito de gran capacidad.
- Mango para facilitar la manipulación
- Ruedas para facilitar el transporte.
- Soporta aceite a altas temperatura (sin limite).

REF.	CARACTERÍSTICAS	1	2	3	4	5	€
15018	Módulo eva juego de vasos para tapones cárter 22pcs	1,45	-	10	480		46,00€
14937	Rueda para recogedor de aceite 80l	0,30	-	14			9,50€
15305	Manguera con grifo en forma de gancho	0,65	-	40			19,50€
15307	Embudo para recogedor de aceite	2,10	-	10	40		39,55€
15309	Tubo de conexión para recogedor de aceite	0,75	-	20			17,00€
15312	Racord para conectar el depósito y la manguera	0,10	5	40			11,50€
15308	Rueda pequeña giratoria	0,35	-	40			7,00€



## BOMBA DE ASPIRACIÓN DE ACEITE - 12V

53566

32,00€



- Extractor de aceite, ideal para los cambios de aceite limpios y rápidos.
- Funciona conectando las pinzas a la batería de 12 voltios del coche.
- El aceite se sustrae del motor del vehículo a través del orificio de la varilla de medición de aceite.
- Se puede usar para extraer aceite de motor, aceite diesel o aceite de calefacción.
- Util también para trasvases generales de los líquidos indicados.

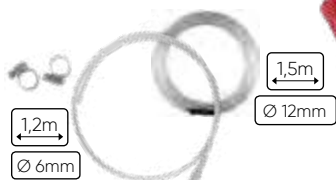
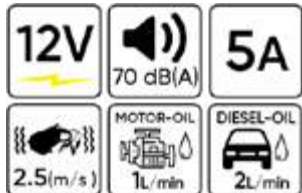

## KIT EXTRACTOR DE ACEITE Y COMBUSTIBLE

53627

22,50€

0,55 12 96



- Diseñado y fabricado para extraer fácilmente aceite, combustible, y fluidos de transmisión / diferenciales de las reservas de los generadores, máquinas de lavado a presión, compresores de aire, tractores para césped y jardín, o ATV's.



## COMPROBADOR DE ANTICONGELANTE

53453

6,00€

0,05 24 96 384



-43°C ~ 131°C

## PISTOLA ENGRASADORA NEUMÁTICA

50751

38,00€

- Presión: 30Mpa.

500ml

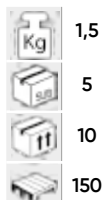

## PISTOLA ENGRASADORA MINI

53849

14,50€

0,30 40



80cc

- Esta pistola engrasadora es perfecta para barcos, motos, bicicletas eléctricas, bicicletas o cualquier otra máquina o equipo que necesite lubricación.
- Muy cómoda para trabajar con una sola mano.

- Boquilla 0.5mm.
- Tapón extraíble con tubo 50°.
- Presión de trabajo 1000 psi.
- Bomba de carga: empuje por muelle.



## PISTOLA ENGRASADORA MANUAL CON TUBO FLEBIXLE

50852

24,50€

1,3 5 20 240



- Ø 14mm exterior.
- Ø 5mm interior.
- Presión: 20Mpa.



500ml



## KIT BOMBA LLENADO SISTEMA TRANSMISIÓN CON ADAPTADORES

52797

227,50€



- Capacidad: 75L.
- Descarga: 80cc ciclo.
- Rango de viscosidad: hasta SAE 140.
- Permite llenado y vaciado

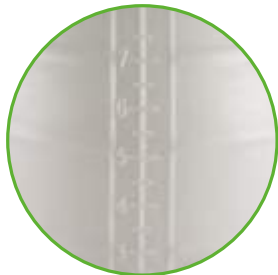

BOMBA LLENADO SISTEMA TRANSMISIÓN SIN ACCESORIOS PARA REF.52797

13234

224,50€



HACE EL VACÍO

## SET DE ADAPTADORES PARA BOMBA DE LLENADO SISTEMA TRANSMISIÓN

12044

147,00€

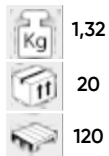

15 PCS

**101**  
FORD 1/8 - 27 (NPT)

**102**  
UNIVERSAL, BMW, HONDA, NISSAN, etc

**103**  
VW/AUDI, SKODA

**104**  
VW/AUDI, PORSCHE

**105**  
VW/AUDI, MINI COOPER M10x1.0

**106**  
VW/AUDI DSG M24x1.5

**107**  
VW/AUDI CVT M22x1.5

**108**  
MERCEDES M12x1.5

**109**  
VW/SKODA M18x1.5

**110**  
AUDI/VW, SKODA, M30x1.5

**111**  
UNIVERSAL FLEXIBLE 300mm, HONDA, HYUNDAI, KIA, etc.

**112**  
VOLVO 5/16 - 24 (UNF)

**113**  
TOYOTA, LEXUS M18x1.0

**114**  
NISSAN, INFINITY M8x1.0

**115**  
ATF - ADAPTER VW PASSAT



## CEBADOR INYECCIÓN DIESEL

52801

24,00€



- Durante la sustitución de la bomba de inyección, filtros u otras partes, evita el retroceso del combustible hacia el depósito.
- Posteriormente al montaje de las partes a sustituir permite bombear el combustible hacia la línea de inyección.



## BOMBA MANUAL PARA EXTRACCIÓN DE GASOIL

52789

15,20€



- Largo manguera: 90cm por extremo.



## CARRETE DE MANGUERA PARA ACEITE BOCA DE 1/2"

**50797**

**490,00€**

26,6 1 14  
Kg t1 t1

Soporte / carrete para aceite  
Longitud de la manguera: 15+1 m  
Presión máxima de trabajo: 2450 PSI  
Entrada de aire: 1/2" BSPT  
Salida de aire: 1/2" BSPT  
Material: Acero



15m

**160  
BAR**

## PISTOLAS DE SUCCIÓN TRANSPARENTES

**52498**

**61,50€**

0,86 6 126  
Kg t1 t1

1.500ml

- Fabricada en polipropileno.
- Cuerpo transparente.
- Apta para uso con aceites de transmisión y diferenciales.
- Resistente a líquido de freno y anticongelantes.

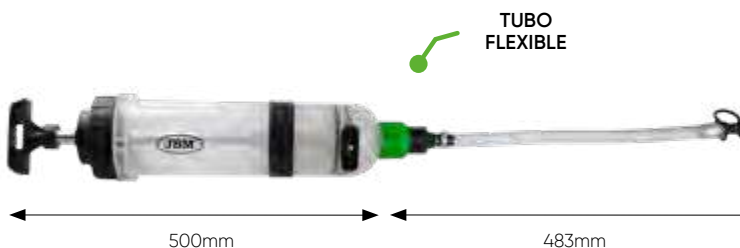

TUBO FLEXIBLE

500mm

483mm



JUEGO DE 2 JUNTAS DE  
RECAMBIO PARA REF. 52498

0,03 50 150  
Kg t1 t1

**11867**

**9,00€**



**52628**

**26,50€**

0,3 5 20 450  
Kg t1 t1 t1

200ml

- Apto para uso en líquido de freno.
- Conector rápido en el extremo.



TUBO FLEXIBLE

300mm

200mm



## PISTOLA SE SUCCIÓN DE ACEITE

**51928**

**13,00€**

0,82 5 20 360  
Kg t1 t1 t1

500ml

ACABADO CROMADO

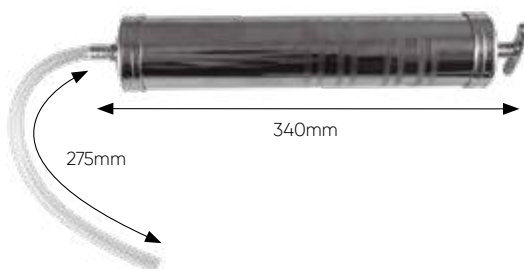

275mm

340mm



## ACOPLADOR DE GRASA DE LIBERACIÓN RÁPIDA

**53592**

**19,60€**

0,15 25 100  
Kg t1 t1

Se recomienda utilizarlo con las pistolas engrasadoras JBM ref. 50751 y 50852, aunque es adecuado para su uso en la mayoría de las pistolas.

- Diseño ergonómico.
- Fácil de manejar: hace que acoplar y desacoplar se realice totalmente sin esfuerzo y ahorrando tiempo de trabajo.
- La válvula de no retorno integrada permite desconectar la unidad fácilmente a presiones de hasta 15.000 PSI (1.034 bar).
- Conexión NPT de 1/8" integrada.



Ø 14mm

Ø 10mm

- 3 mandíbulas endurecidas resistentes a altas presiones sin deformación.





## MÁQUINA PARA CAMBIO DE ACEITE DE TRANSMISIÓN

**54050**

**980,00€**

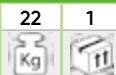

Permite el cambio automático del aceite de transmisión.

- Fuente de alimentación: 12 V (batería de coche)
- Potencia de la bomba: 70 W
- Diámetro del manómetro de aceite: 70 mm (ambos manómetros)
- Rango del manómetro de aceite: 0-10 bar (0-150 psi) (ambos manómetros de aceite)
- Capacidad del depósito de aceite nuevo: 30 litros
- Capacidad del depósito de aceite usado: 30 litros

Incluye:

- 1 dispositivo de intercambio y lavado
- 1 juego de adaptadores con 37 adaptadores de conexión / adaptadores de manguera
- 1 manguera de conexión roja con acoplamiento rápido, longitud 250 mm, diámetro 12,5 mm (1/2"), máx. 20 bar (300 psi)
- 1 manguera de conexión negra con acoplamiento rápido, longitud 250 mm, diámetro 12,5 mm (1/2"), máx. 20 bar (300 psi)



Incluye maletín con adaptadores para diferentes marcas (Volkswagen, BMW, Land Rover, Ford, Mercedes, Buick).



PINZAS PARA BATERÍA DE 12V

SET DE ADAPTADORES PARA REF.54050

**15539**

**103,50€**



FILTRO

**15542**

**45,00€**

**0,65 20**



## REFRACTÓMETRO PARA ALCOHOLES

**50731**

**68,00€**

**0,56 5 500**



## REFRACTÓMETRO UNIVERSAL

**52963**

**48,00€**

**0,28 5 20 440**



UREA AUS32

- Etileno glicol: -50°C ~ -0°C.
- Propileno glicol: -50°C ~ -0°C.
- Líquido limpiaparabrisas: -40°C ~ -0°C.
- UREA AUS32: 30% ~ 35%.
- Líquido de batería: 1.100 - 1.400 sg/l.



## RECOGEDORES PVC

Salida de evacuación lateral / Asas de carga / PVC muy resistente / Compacto.

### PARA ANTICONGELANTE

**53215**

**18,00€**

**0,95 8 32**



**18L**

- Medidas: Alto: 185mm / Diámetro: 380mm.



### PARA ACEITE

**53144**

**18,00€**

**0,99 8 64**



**18L**

- Medidas: Alto: 185mm / Diámetro: 380mm.



## BANDEJA DE DRENAJE DE ACEITE

**54051**

**50,50€**

**4,4 4**



**110mm**

**600mm**

**330mm**

**8L**

**PE**



## BANDEJA DE ACERO PARA LIQUIDOS

**51356**  
68,00€

2,39 5 40  
Kg ft cm  
23 L 110mm 400mm 600mm



## ACEITERA 250ml

**52243**  
7,50€

0,17 5 60 720  
Kg ft cm ml  
250ml



## JARRA CON CUELLO FLEXIBLE

**52991**  
10,50€

0,16  
Kg ft cm  
20 240

2L



**52992**  
18,00€

0,36  
Kg ft cm  
8 96

5L



## ACEITERA 500ml

**52242**  
12,00€

0,28 10 60 480  
Kg ft cm ml  
500ml



## EMBUDO PARA BIDÓN DE 200L CON TAPA Y FILTRO

**53187**  
39,00€

0,75 1 18 54  
Kg ft cm L  
4,5L



- Ø Interior: 245mm.  
- Ø Exterior: 260mm.

FILTRO

## SET DE 3 EMBUDOS

**53188**  
7,00€

0,15 24 288  
Kg ft cm

Ø 90mm 130mm 180mm



## EMBUDO CON FILTRO

**52391**  
5,00€

0,09  
Kg ft cm  
5 20 400



950ml  
140 x 15mm

## SET 2 EMBUDOS MINI

**52392**  
5,00€

0,07 100 800  
Kg ft cm



5,5 x 13 / 4,5 x 13mm

## EMBUDO CON TUBO FLEXIBLE

**53198**  
9,50€

0,15 24 168  
Kg ft cm

Ø 180mm

1,89L





GATOS HIDRÁULICOS



256

CABALLETES



259

GATOS BOTELLA



258

PORTA RUEDAS



261

PRENSAS



262

GRÚAS



263

SOPORTES PARA MOTORES



264

PARA MOTOCICLETAS



265

TRANSPALET



266



# HERRAMIENTAS HIDRÁULICAS

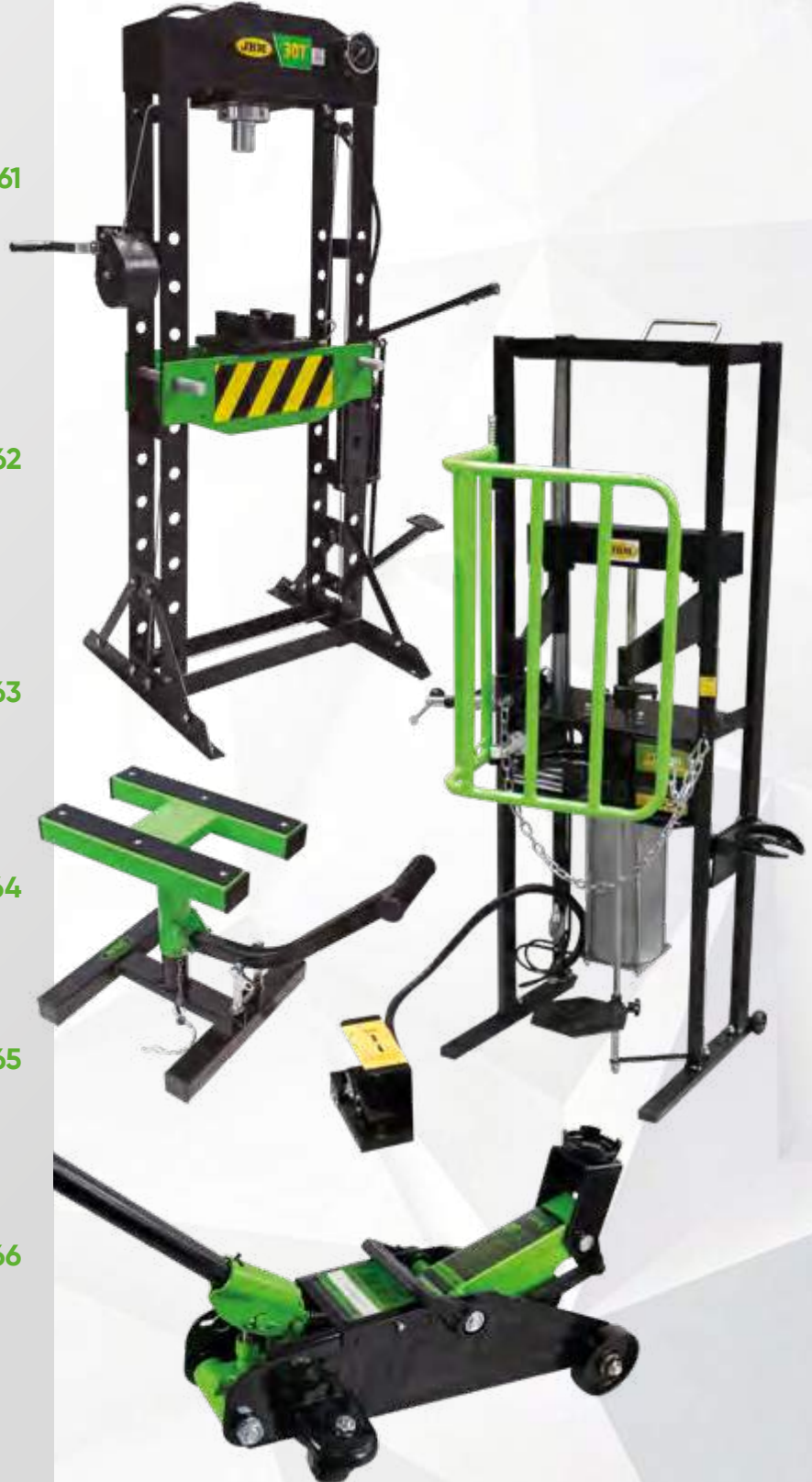

## GATO HIDRÁULICO - SISTEMA SUBIDA RÁPIDA

**53725**

298,00€

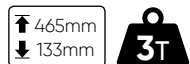

CAZOLETA CON PROTECCIÓN DE GOMA

RUEDAS DE NYLON



PISTÓN DE RECAMBIO

**14709**

121,50€



## GATO HIDRÁULICO CON PALANCA DE ELEVACIÓN

DOBLE PISTÓN

**53422**

368,00€



PALANCA DE ELEVACIÓN

ESPUMA

CAZOLETA CON PROTECCIÓN DE GOMA

RUEDAS DE NYLON

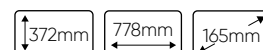

RUEDA GIRATORIA PARA REF. 53422

**14071**

21,50€



RUEDA FIJA PARA REF. 53422

**14072**

21,50€



PISTÓN PARA REF. 53422

**14073**

128,00€

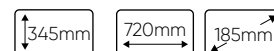

PISTÓN HIDRÁULICO PARA GATO REF. 53112

**13853**

122,00€

PROTECTOR DE GOMA PARA GATO REF. 53112

**13836**

9,00€



**53112**

299,00€



SUBIDA RÁPIDA



## GATO HIDRÁULICO - COCHES BAJOS

**50816**

88,00€

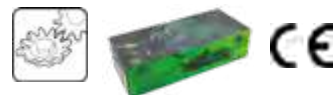
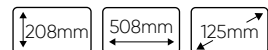

PISTÓN DE RECAMBIO PARA REF. 50816

**14708**

59,00€



DOBLE PISTÓN

**53421**

314,00€

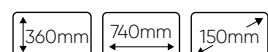

RUEDAS DE NYLON

CAZOLETA CON PROTECCIÓN DE GOMA

ESPUMA



RUEDA GIRATORIA PARA REF. 53421

**14068**

13,00€



PISTÓN PARA REF. 53421

**14070**

115,50€



RUEDA FIJA PARA REF. 53421

**14069**

13,00€





# GATO HIDRÁULICO CARRETILLA

**50818**

279,00€

37,5 1 18  
Kg fl

346mm 685mm 180mm

495mm 133mm **3,5T**



**CE** EN 1494:2001



GOMA PARA CAZOleta PARA REF. 50818

**14615** 0,05 100  
9,50€ Kg fl

PISTÓN DE RECAMBIO PARA REF. 50818

**10768** 6,43 1  
112,50€ Kg fl

CAZOleta DE APOYO PARA REF. 50818

**10769** 1  
21,00€ fl

TORNILLO DE SUJECIÓN LATERAL PARA REF. 50818

**10639** 0,34 5  
10,90€ Kg fl

MUELLE CRICK PARA REF. 50818

**10770** 0,05  
6,00€ Kg

**53968**

49,00€

5,80 1 90  
Kg fl



205mm 490mm 140mm

355mm 130mm **2T**

**CE** EN 1494:2001



**50815**

88,00€

10,6 1 56  
Kg fl

205mm 490mm 140mm

355mm 130mm **2T**



EN CAJA PLÁSTICA

**51895**

99,00€

11,5 1 42  
Kg fl

205mm 490mm 140mm

355mm 130mm **2T**



PISTÓN HIDRÁULICO PARA REF. 50815

**11939** 6 5  
62,50€ Kg fl

PISTÓN HIDRÁULICO PARA REF. 51895

**11939** 6 5  
62,50€ Kg fl



## GATO BOTELLA 20T

**50823**  
98,00€

10 2 96  
Kg fl. m<sup>2</sup>  
↑ 452mm  
↓ 242mm

**20T**



CE

## GATO BOTELLA 20T COCHES BAJOS

**50824**  
93,50€

8,35 2 96  
Kg fl. m<sup>2</sup>  
↑ 335mm  
↓ 190mm

**20T**



CE

## GATO BOTELLA 30T

**50825**  
154,00€

13,76 2 72  
Kg fl. m<sup>2</sup>  
↑ 465mm  
↓ 285mm

**30T**



CE

## GATOS BOTELLA 2-15T

**50819**  
28,00€

2,43 1 288  
Kg fl. m<sup>2</sup>  
↑ 345mm  
↓ 181mm

**2T**

**50820**  
34,50€

3,22 6 300  
Kg fl. m<sup>2</sup>  
↑ 372mm  
↓ 194mm

**3T**

**50821**  
47,00€

4,22 5 200  
Kg fl. m<sup>2</sup>  
↑ 413mm  
↓ 216mm

**5T**

**50822**  
61,00€

5,79 4 160  
Kg fl. m<sup>2</sup>  
↑ 460mm  
↓ 230mm

**10T**

**52304**  
84,00€

7,59 2 144  
Kg fl. m<sup>2</sup>  
↑ 365mm  
↓ 225mm

**15T**



CE

## GATO BOTELLA CON CAJA PLÁSTICA 2-5T

**51905**  
34,50€

2,76 6 144  
Kg fl. m<sup>2</sup>  
↑ 340mm  
↓ 185mm

**2T**

**51906**  
40,00€

3,58 4 144  
Kg fl. m<sup>2</sup>  
↑ 385mm  
↓ 195mm

**3T**

**51907**  
50,00€

4,74 4 96  
Kg fl. m<sup>2</sup>  
↑ 450mm  
↓ 215mm

**5T**



CE



## JUEGO DE DOS CABALLETES

**53779**  
45,00€

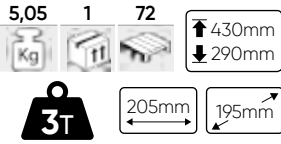

**2**  
PCS

**53845**  
88,00€

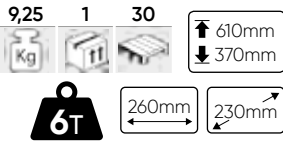

## GATO DE TIJERA

**53218**  
24,00€



- Adecuado para todos los coches.

## CABALLETES DE ALUMINIO

**53200**  
69,00€



## GATO ELEVADOR DE TRINQUETE 3T

**53895**  
111,50€

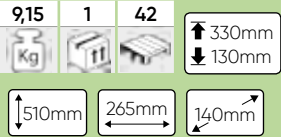

- Material: acero 45



Diseñado para elevar **vehículos pesados, como todoterrenos, camiones y tractores**, así como para realizar **tareas de arrastre, sujeción, y tracción y empuje.**

Es **ideal e indispensable** para las actividades fuera de la carretera, **fácil de manejar, fácil de transportar** y sirve como una **herramienta polivalente** para cualquier vehículo y terreno.

**53896**  
139,00€

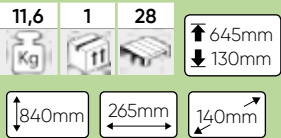

**53897**  
168,00€

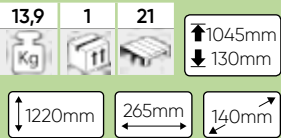

**53898**  
195,00€

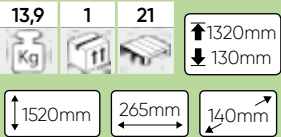

**SOPORTE PARA RUEDA DE RECAMBIO**

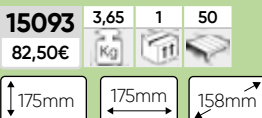

Diseñado para mantener el gato seguro en el soporte para la rueda de repuesto de los 4x4 al circular fuera de la carretera. Su base ajustable lo hace óptimo para la mayoría de los vehículos.



**BASE OFF-ROAD**

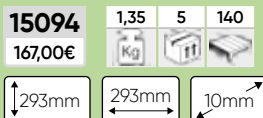

Diseñado para estabilizar el gato en terrenos blandos, aumentando la superficie de apoyo y evitando el hundimiento.



**SOPORTE DE BLOQUEO DEL MANGO**

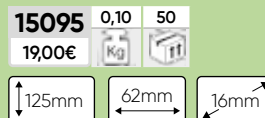

Diseñado para bloquear la manivela del gato durante el transporte.



**GANCHO DE ELEVACIÓN**

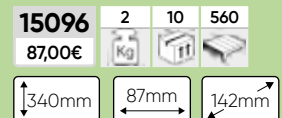

Diseñado para elevar el vehículo directamente de la rueda cuando se necesita una mayor capacidad de elevación.

## GATO DE FOSO

**54001**

**285,00€**

32,7

1

4



↑1.900mm  
↓1.100mm

900mm

**500**  
KG

- Aceite SAE 40.
- De construcción sólida y sistema hidráulico de alta calidad.
- Con pedal para un uso sencillo y rápido.

### SET DE 4 RUEDAS

**15526**

3,5

50

**47,50€**



### PISTÓN DE RECAMBIO

**15527**

16

1

**276,00€**



### SOPORTE DE DOBLE POSICIÓN

**15528**

2

50

**39,00€**



2 POSICIONES



VÁLVULA DE SEGURIDAD



1900mm  
1100mm

## GATO HIDRÁULICO DE TRANSMISIÓN

**50830**

**560,00€**

52,5

1

6



↑1.740mm  
↓850mm

- Con agarradero
- Rápida
- Doble pistón



## GATO DE FOSO

**53161**

**298,00€**

32,7

1

4



↑1.910mm  
↓1.130mm

900mm

**500**  
KG

- Aceite SAE 40.
- De construcción sólida y sistema hidráulico de alta calidad.
- Con pedal para un uso sencillo y rápido.
- 5 ruedas para una mejor estabilidad.



2 POSICIONES



1910mm  
1130mm

CE



SOPORTE DE DOBLE POSICIÓN PARA 50830

**14929**

1,95

10

**21,50€**



PISTÓN DE RECAMBIO PARA REF. 50830

**12046**

**385,00€**



TACO PARA REF. 53161

**14182**

1,95

10

100

800

**21,00€**



PISTÓN DE RECAMBIO PARA REF. 53161

**13892**

1,95

2

**195,50€**



BOLA RETÉN PARA REF. 53161

**14329**

**0,50€**



SOPORTE DE DOBLE POSICIÓN PARA 50830

**14929**

1,95

10

**21,50€**



Útil para gatos comparados con anterioridad que no lo llevaban incorporado.

Útil para gatos comparados con anterioridad que no lo llevaban incorporado.



## PORTA RUEDAS HIDRÁULICO

51901

999,00€



- Largo total: 1040mm.
- Anchura total: 1090mm.
- Altura total: 890mm.
- Rango de elevación: 50 - 100mm.
- Diámetro máx. de las ruedas: 1.320mm.

1T



CE

## PORTA RUEDAS HIDRÁULICO ESPECIAL PARA RUEDAS TRACTOR

52241

1.690,00€



- Capacidad: 1,5T
- Rango de elevación: 0-770mm
- Largo total: 1270mm
- Anchura total: 990mm
- Altura total: 1340mm
- Diámetro máximo de rueda: 2200mm (86")
- Diámetro mínimo de rueda: 1000mm (39")
- Ancho máximo de rueda: 800mm



GANCHO SUPERIOR PARA SUJECIÓN DE LA RUEDA DURANTE EL TRANSPORTE



RUEDAS FORRADAS EN PU DE ALTA RESISTENCIA QUE EVITA MARCAS EN EL SUELO



## CURVADORA DE TUBOS

50835

290,00€



DISEÑADO PARA USO VERTICAL Y HORIZONTAL

- Construcción de acero robusto capaz de doblar tubos hasta 2" (50mm).
- Adecuado para instalación y fabricación de tuberías.
- Diseñado para uso horizontal y vertical.
- Barras dobladoras ajustables para acomodar la distancia deseada.

- Capacidad máxima: 12T
- Presión del aire: 0,75 - 0,85mpa
- Dimensiones: 68x58,5x18,5cm
- Tamaños cuñas: 1/2", 3/4", 1", 1-1/4", 1-1/2", 2".



12T

680mm

585mm

195mm

PISTÓN DE RECAMBIO

13870 6,70 1  
82,00€

SET DE 6 CUÑAS

15255 8,75 1  
113,50€

CE

## PRENSA DE 30T

**53684** 206 1  
**1.880,00€** Kg fl

- Trazo lateral (mm): 200.
- Recorrido: 150mm
- Accionado manual y con el pie.

- Capacidad (T): 30.
- Trazo (mm): 160.
- Rango operativo (mm): 166-1126.
- Ancho de la base (mm): 540.

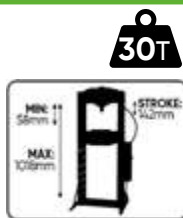

PISTÓN CON DESPLAZAMIENTO HORIZONTAL



CABRESTANTE MANUAL PARA AJUSTAR LA ALTURA DE LA MESA DE PRESIÓN



## PRENSA DE 20T

**53590** 114,50 1 9  
**1.190,00€** Kg fl

- Capacidad (T): 20.
- Trazo (mm): 145.
- Rango operativo (mm): 58-1018.
- Ancho de la base (mm): 540.
- Ancho interior (mm): 536.
- Trazo lateral (mm): 180.

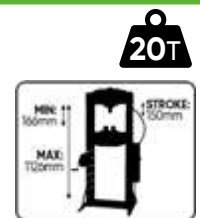

PISTÓN CON DESPLAZAMIENTO HORIZONTAL



2 VELOCIDADES

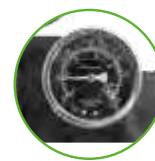

PANTALLA PROTECTORA

**14616**  
95,90€

PISTÓN

**15044**  
259,00€

MANÓMETRO

**15046**  
46,50€

PALANCA

**15048**  
5,00€

PANTALLA PROTECTORA

**14616**  
95,90€

PISTÓN

**15043**  
194,50€

MANÓMETRO

**15047**  
46,50€

PALANCA

**15048**  
5,00€

BOMBA

**14639**  
195,00€

## BASE DE TRABAJO PARA PRENSA HIDRÁULICA

**52999** 7,6 2 120  
**168,00€** Kg fl **30T**

BLOQUE GRANDE

200mm 250mm 40mm

BLOQUE PEQUEÑO

70mm 200mm 40mm

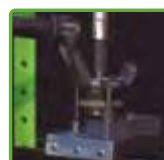



## COMPRESOR DE MUELLES PARA AMORTIGUADORES

**50827**  
387,00€

32,45 1 18  
Kg 1T 18

830mm 350mm 190mm

- Capacidad: 1T (2200 lbs)
- Diámetro del muelle comprimido: 200mm
- Rango de compresión: 200-500mm



## COMPRESOR PARA AMORTIGUADORES 1T

**53742**  
999,00€

66,50 1 6  
Kg 1T 6

410mm 690mm 560mm



ALIMENTACIÓN NEUMÁTICA

- Capacidad: 1000kg
- Longitud máxima de trabajo: 450mm
- Longitud de carrera del cilindro: 420mm
- Diámetro del muelle: Ø102-165mm
- Sentido de rotación: Horario
- Presión de aire máxima: 6.5 - 8 bar (94.27-130.53 psi / 0.65-0.9 MPa)
- Modo de funcionamiento: Pedal de pie

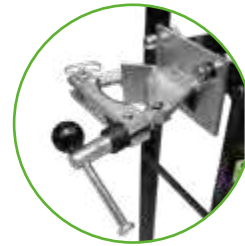

## GRÚA DE 1T PLEGABLE

**52985**  
598,00€

74 1 16  
Kg 1T 16

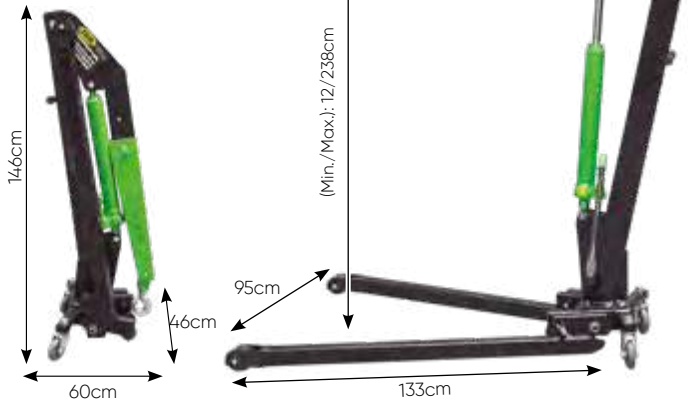

RECAMBIO DE PISTONES PARA 52985  
**13672** 0,02 200  
220,00€

JUNTA DEL PISTÓN PARA REF. 52985  
**14589** 100  
2,50€

## GRÚA DE 2T PLEGABLE

**50831**  
460,00€

81,4 1 20  
Kg 1T 20

1460mm 1060mm 1750mm



2.620mm  
60mm

Altura elevación:  
1'80m (2T) - 2,19m (1/2T)

- Dimensiones plegada: 800 x 680 x 1.600mm.
- Capacidad de elevación: Posición 1: 2T - 80mm. Posición 2: 1½T - 255mm. Posición 3: 1T - 425mm. Posición 4: ½T - 610mm.



## SOPORTE ALINEADOR DE MOTOR

**50631**  
68,00€

6,3 1 98  
Kg 1T 98



GRÚA NO INCLUIDA.



RUEDAS GIRATORIAS PARA REF. 50831  
**12032** 6  
7,50€

PISTÓN RECAMBIO GRÚA HIDRÁULICA PARA REF. 50831  
**14090** 10,30 1  
103,00€

JUEGO DE TORNILLERÍA PARA REF. 50831  
**11323** 2,04 1  
16,00€



## SOPORTE PARA MOTORES

**50840**

20,45 1 35

1750mm

**500 KG**

144,00€



ENGANCHE Y PALOMILLA PARA REF. 50840

**51452**

3,43 1

69,00€

CE

**53682**

15,45 1 36

1500mm

**500 KG**

129,00€



CE

## SOPORTE PARA MOTOR UNIVERSAL

**52055**

10 1 40

129,00€

- Adaptable a todo tipo de automóviles y furgonetas.
- Ideal para el cambio de la correa de distribución o de las correas auxiliares, sustitución o cambio de inclinación de la correa delantera.
- Ahorro, con una herramienta se pueden hacer tareas sólo realizables con herramientas específicas.
- Manejo simple.
- Rápida colocación con sólo la necesidad de un operario.
- Colocación y acceso por la parte inferior.
- Pieza perpendicular con ángulo de giro y ajustable a cualquier altura de la barra longitudinal.
- Altura de los ganchos ajustable, 360° de rotación de los ganchos.
- Platina plástica de apoyo para evitar el desplazamiento del punto de apoyo de la barra.



**500 KG**



CE

## SOPORTE PARA MOTORES

**50836**

18,15 1 36

148,00€

**340 KG**

850mm

900mm

800mm



**50838**

43,9 1 12

299,00€

**900 KG**

900mm

1100mm

900mm

- Dimensiones plegado: 100 x 50 x 44cm.



CE

## CABALLETE ELEVADOR DE MOTOCICLETA

**53969**

6 1 32

96,00€

**150 KG**

400mm  
300mm

328mm

293mm

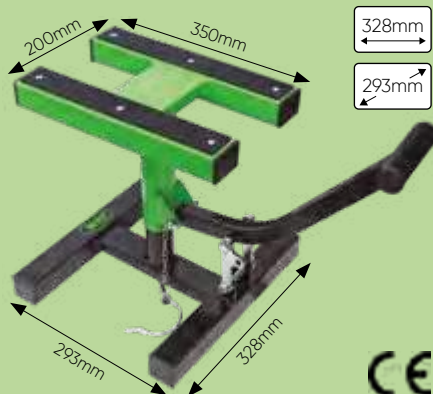

CE

## GATO PARA MOTOCICLETA

**52692**

13,5 1 50

129,00€

**500 KG**

400mm  
95mm

- Accionamiento con vaso de 21mm.



CE



## MESA HIDRÁULICA

**53246**

1.144,00€

104

1

4



**360**  
KG

↑ 1.350mm  
↓ 370mm

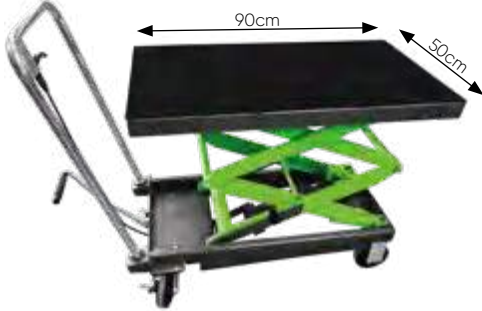

## MESA HIDRÁULICA

**50630**

599,00€

62

1

5



**400**  
KG

↑ 780mm  
↓ 290mm

↑ 480mm  
← 840mm

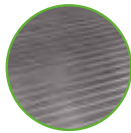

CE

## MESA HIDRÁULICA PARA MOTOCICLETAS

**50911**

1.245,00€

135

1

5



↑ 780mm  
↓ 205mm

**365**  
KG

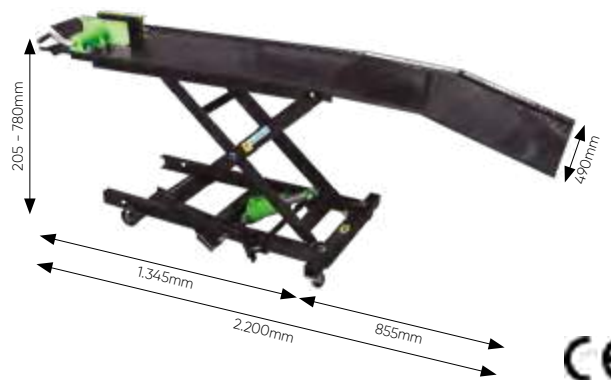

CE

PISTÓN DE RECAMBIO  
PARA REF. 50630

**10993**

8,80

1

116,55€



EJE DE RECAMBIO  
PARA REF. 50630

**11950**

0,03

18,00€



SET DE 2 RUEDAS CON  
FRENO PARA 50911

**14706**

0,63

25

8,90€



PISTÓN DE RECAMBIO  
PARA REF. 50911

**14727**

8,1

1

108,00€



## MESA HIDRÁULICA PARA MOTOCICLETAS

**51750**

299,00€

31

1

12



**135**  
KG

↑ 890mm  
↓ 340mm

↑ 500mm

← 450mm

↓ 340mm

CE



## GATO ELEVACIÓN QUAD

**53423**

199,00€

28,5

1

24



↑ 790mm

← 370mm

↓ 330mm

NYLON

↑ 368mm  
↓ 118mm

**680**  
KG



PALANCA DE  
ELEVACIÓN



PISTÓN PARA REF. 53423



4,60

3

**14291**

86,50€

RUEDAS  
DE NYLON

## SET DE 2 RAMPAS ELEVADORAS

52845

199,00€



2 PCS

- Útil para presentar vehículos de exposición, así como para realizar trabajos de mantenimiento en la parte inferior del vehículo.

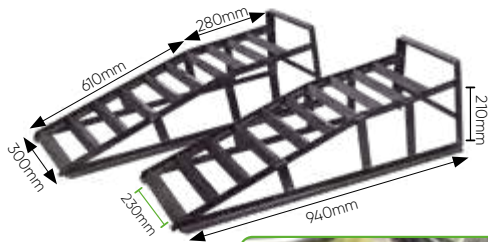

## SOPORTE ELEVADOR PARA MOTOS

DELANTERO

52514

94,00€



200 KG

TRASERO

51751

125,50€



200 KG

GARRAS PARA SOPORTE ELEVADOR DE MOTO

PLANAS (x2)

10671

15,20€

0,63 2

255mm

REDONDAS (x2)

11892

12,50€

0,15 50

20mm

## PORTADOR HIDRÁULICO 680Kg

50839

224,00€



- Longitud plástico negro de las patas: 300mm.  
- Longitud con ruedas: 600mm.



PISTÓN PARA REF. 50839

15085

156,00€

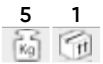

RUEDA PARA REF. 50839

12889

12,00€

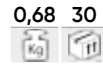

680 KG

## CARRO TRANSPORTADOR ESPECIAL PLANCHA

50923

390,00€



480mm

1.300mm

800mm

340 KG

- Separación de 0 a 110cm.



CE

RUEDA PARA REF. 50923

12022

33,70€

## TRANSPALLET MANUAL ELEVACIÓN RÁPIDA

53880

598,00€

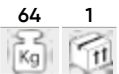

- Capacidad de carga: 2500kg  
- Longitud horquilla: 1150mm  
- Empuñadura: Cuadrada con protección de goma.  
- Ruedas de dirección: PU (200x50mm)  
- Rodillos de carga: PU (80x70mm)  
- Altura mínima horquilla: 85mm  
- Altura máxima horquilla: 200mm  
- Velocidad de elevación: 8



BOMBA DE ELEVACIÓN RÁPIDA (ACERO FUNDIDO)

2,5T

JUEGO DE 2 PASADORES PARA EJE DE BARRA DE TRACCIÓN

14785

3,50€

- 25

Kg

RODILLO DE HORQUILLA

14938

41,50€

0,9 40

Kg

RUEDA DE DIRECCIÓN

14939

57,00€

2,6 20

Kg

BOMBA

14940

248,00€

10 1

Kg



ARRANQUE DE VEHÍCULOS



268

PARA BATERÍAS



269

MEDIDORES DE CORRIENTE



270

TERMÓMETROS



271

ENDOSCOPIO WIFI / DETECTOR DE FUGAS  
POR HUMO / PISTOLA DE CALOR /  
SOLDADORES/ PARA RALLAR NEUMÁTICOS  
/ AMOLADORAS



272

LIMPIADORAS DE PIEZAS / ASPIRADORA



275

HIDROLIMPIADORAS



278

CARRETES DE CABLE ELÉCTRICO



279

VENTILADORES / ADAPTADORES DE  
ENCHUFE



280



# HERRAMIENTAS ELÉCTRICAS



**SERIE364**

## CABLES DE ARRANQUE

### PINZA MACIZA DE LATÓN

REF.	Ø CABLE + FUNDA	LARGO	A	SECCIÓN	kg	U	U	€
51238	17mm	5m	700	70mm <sup>2</sup>	5,02	2	72	129,00€
51239	15mm	7m	700	70mm <sup>2</sup>	5,98	2	72	156,00€



### PINZA DE LATÓN

REF.	Ø CABLE + FUNDA	LARGO	A	SECCIÓN	kg	U	U	€
52069	11mm	2,5m	250	25mm <sup>2</sup>	1,62	5	160	26,50€
52070	12mm	3m	350	35mm <sup>2</sup>	2,1	5	160	36,00€
52071	13mm	3m	500	50mm <sup>2</sup>	2,34	5	90	42,50€



### PINZA MACIZA DE LATÓN CON PROTECTOR SOBRECARGA

REF.	Ø CABLE + FUNDA	LARGO	A	SECCIÓN	kg	U	U	€
51363	12mm	3m	350	35mm <sup>2</sup>	2,63	5	120	103,00€
51365	12mm	3m	600	50mm <sup>2</sup>	3,12	5	90	106,00€



CE



**PINZA PARA CABLE DE ARRANQUE COBRE - ROJA**  
**14145** 0,20 30  
 8,50€



**PINZA PARA CABLE DE ARRANQUE COBRE - NEGRA**  
**14146** 0,20 30  
 8,00€



**PINZA PARA CABLE DE ARRANQUE LATÓN - ROJA**  
**14147** 0,35 15  
 25,00€



**PINZA PARA CABLE DE ARRANQUE LATÓN - NEGRA**  
**14148** 0,35 15  
 25,00€

### SET DE 2 PINZAS DE COCODRILO

**53357** 0,01 6 24  
 7,00€



2 PCS 30 AMP

## ARRANCADOR DE VEHÍCULOS



**53687** 11,35 1 14  
 298,00€

**53688** 18,05 1 14  
 480,00€

12V DC 15A 230V 50Hz 12V 1A 6-40H

**53687** 12V 9,5kg

- Voltaje: 12V.
- Batería: 22Ah batería de plomo ácido AGM (1PC).
- Corriente de arranque: 750A.
- Corriente máxima: 1500A.

**53688** 12V 24V 16,3kg

- Voltaje: 12V/24V.
- Batería: 22Ah batería de plomo ácido AGM (2PC).
- Corriente de arranque/máxima: 12V: 1500A/3000A. 24V: 750A/1500A.
- Tiempo de carga de la batería: Batería totalmente descargada: 40 horas. Batería cargada un 10-20%: 6 horas.



370mm 392mm 209mm

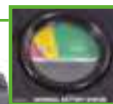

Medidor de voltaje de la batería interna



Botón de comprobación de voltaje de la batería interna



Interruptor encendido/apagado



Toma de carga



PINZAS



LUZ LED INCORPORADA: AMPLÍA LA VISIBILIDAD DE LA ZONA DE TRABAJO



## RECAMBIOS

REF.	CARACTERÍSTICAS	kg	U	€
14755	Batería 22Ah para ref. 53687,53688	6,50	2	133,15€
14756	Placa base para ref. 53687	0,05	10	15,15€
14757	Placa base para ref. 53688	0,05	10	15,15€
14758	Cable de arranque rojo con pinza para ref. 53687,53688	0,40	10	18,00€
14759	Cable de arranque negro con pinza para ref. 53687,53688	0,40	10	18,00€

14755



14756



14757



14758



14759





## CARGADORES DE BATERÍA

6/12V

53927

0,55 5 20

58,00€



COMPATIBLE CON BATERÍAS DE PLOMO ÁCIDO: HÚMEDAS, GEL, MF Y AGM

12/24V

53929

0,85 5 20

78,00€



## MEMORIZADOR PARA CAMBIO DE BATERÍA

52884

0,25 5 20 400

69,50€



- Útil para mantener corriente en el sistema eléctrico del vehículo durante el cambio de batería.  
- Conexión mediante cable OBDII o toma de mechero.

235mm ± 20mm

2,070mm ± 20mm



## COMPROBADOR DE BATERÍAS DIGITAL

51816

0,3 6 48 576

49,00€



- 150Ah.  
- Aplicable en baterías de 12V.  
- Medición en SAE (CCA), EN, IEC, DIN, CA.  
- Rango: 200~1200 CAA (SAE).  
- Medidor de voltio: 7V-15 V.  
- Display 4 + 3 Leds (verde, rojo, amarillo).



## COMPROBADOR DE BATERÍAS

51235

1,35 10 150

49,00€



- Para baterías de 6V y 12V.  
- Carga de hasta 100Ah.  
- Test de Estado de carga.  
- Test de consumo de Arranque.  
- Test de Voltaje de carga.  
- Test de Condición de la Batería.



## COMPROBADOR DE BATERÍA Y ALTERNADORES CON IMPRESORA

52233

2,32 6 72

288,00€



- Aplicable a baterías de 6V y 12V.  
- Sistemas de carga y encendido de 12V y 24V.

- Rango de operación: 40 - 2000 CCA (SAE).  
- Voltímetro: 1.5V - 30V.  
- Juego de cables de 180cm.

- Incluye:  
Pilas 6x1.5AA.  
1 rollo de papel térmico.



PAPEL TÉRMICO 57mmx60m

51842

6,90€

0,1 6 120



CON IMPRESORA

AGM, GEL, VRLA, SLI

## DENSÍMETRO PARA BATERÍAS

53209

0,15 10 100

7,50€

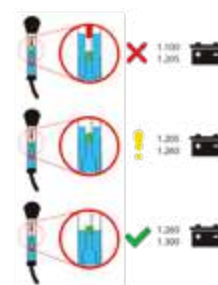

## COMPROBADOR DE BATERÍA CON IMPRESORA

**54040** 1,2 10  
**198,00€** Kg fl

- Aplicable a baterías de 12V, AGM, GEL, VRLA, SLI.
- Rango de operación: 100 - 2000 CCA (SAE)
- Idiomas disponibles en el sistema: ES (Español), EN (Inglés), FR (Francés), DE (Alemán), IT (Italiano), PT (Portugués), RO (Rumano).
- Aplicable a sistemas de arranque de 12/24V
- Aplicable a baterías de 12V, AGM, GEL, VRLA, SLI.
- Comprobador arranque y alternador.

\*Incluida una pila CR2032



CON IMPRESORA

## PINZA AMPERIMÉTRICA

**52382** 0,23 5 50 1.600  
**18,00€** Kg u.s. fl



- FUNCIONES:  
Test de cable.

**52952** 0,26 5 50 1.500  
**64,80€** Kg u.s. fl



- FUNCIONES:  
Test de cable.  
Test de diodo.  
Test de continuidad.  
Función ADP.  
Función de detección de fase.  
Interruptor ZERO.

	52382	52952
DCB	600V	20V, 600V
ACB	600V	600V
DCA		200A
ACA	20A, 200A, 600A	200A
OHM	2KΩ, 200KΩ, 2MΩ	2000Ω



52382



52952



- Instrumento ideal para electricistas
- Se puede medir: voltaje AC, voltaje DC, Corriente AC, resistencia, diodo, frecuencia.
- Entorno de funcionamiento: 0°C a 40°C, a <80%RH.
- Entorno de almacenamiento: -10°C a 40°C, a <85%RH.
- Alimentación: 2 pilas AAA.

- Indicador de batería baja.
- Pantalla de 3,5" con 4 dígitos.
- Función de corriente continua.
- Medición de voltaje AC/DC.

## MULTÍMETRO DIGITAL

**50942** 0,33 10 60 480  
**24,00€** Kg u.s. fl

- Indicador de batería.
- Baterías de 9V.
- Sonda de temperatura.
- Temperatura de -40°C a 1000°C.

- Dígitos: 3 1/2.
- Medición: 2.000.
- Datos instantáneos.
- Autoapagado.

CON PROTECTOR LATERAL



V AC	200mV, 2V, 20V, 200V, 1000V	A AC	20mA, 200mA, 20A
V DC	200mV, 2V, 20V, 200V, 750V	A DC	20mA, 200mA, 20A
Ω	200Ω, 2KΩ, 20KΩ, 200KΩ, 2MΩ, 20MΩ, 2000MΩ		
F	2nF, 20nF, 200nF, 2μF, 20μF, 200μF		



## JUEGO DE CABLE Y ACC. PARA REF. 50942

**52439** 3,26 1 5 40  
**214,00€** Kg u.s. fl

- 2 medidores de resistencia variable.
- 2 luces led de comprobación.
- 2 SRS sustitución y de los dispositivos de prueba.
- 2 alicates de cocodrilo.
- 2 tomas de enganche rápida.
- 4 sondas.
- 24 conectores forma redonda.
- 48 conectores forma plana.





## SET DE ACCESORIOS PARA MULTÍMETRO

52231

0,41 5 40 300

45,50€



- Kit apto para la mayoría de multímetros.

- Incluye:  
2 sondas.  
2 pinzas pequeñas  
2 pinzas largas.  
Cables de extensión.



## COMPROBADOR DE CORRIENTE

53028

0,07 10 120 1.800

4,00€



6-12-24V

1,8 x 190mm



53029

0,08 12 240 2.400

5,50€



6-12-24V

2 x 115mm



53030

0,17 6 60 720

10,00€



6-12-24V

LED  
3 x 142mm



- Aptos para comprobar la polaridad

## TERMÓMETRO LÁSER

### -50° A 550°C

52162

0,17 6 72 576

32,50€



- Termómetro de infrarrojos.  
- Lectura de: -50°C ~ 550°C / -58°F a 1022°F.  
- Tolerancia ± 2°C.

- Funciones:  
Indicación por puntero láser.  
Alarma de temperatura máxima o mínima.  
Lectura en °C / °F.  
Función de memoria de resultado.  
Indicador de batería baja.

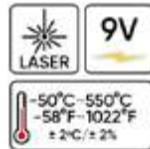

### -50° A 1.000°C

52450

0,72 5 20 200

117,50€



- Termómetro de infrarrojos.  
- Lectura de -50°C ~ 1000°C (-58°F ~ 1832°F).  
- Tolerancia +/- 1,5°C.

- Funciones:  
Indicación por puntero láser.  
Alarma de temperatura máxima o mínima.  
Lectura en °C / °F.  
Función de memoria de resultado.  
Indicador de batería baja.



## TERMÓMETRO DIGITAL DE CONTACTO

53503

0,05 20 100

8,50€

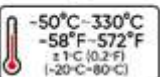

## COMPROBADOR DE LÍQUIDO DE FRENOS

51839

0,05 10 100 2.400

24,00€



- Funciona a pilas 1xAAA LR03.  
- Con 4 niveles de calidad medibles del 0% al 4%.



## ENDOSCOPIO WIFI

**53724**  
39,00€

0,15 20 60 500  
Kg uB ft

720p  
20FPS HD



- Endoscopio con conexión wifi compatible con todos los smartphones del mercado. Apta para conectar con tabletas y PC.

- El equipo incluye:

**Endoscopio.**

**Puerto de conexión wifi.**

**Cargador.**

**Punta de gancho.**

**Punta magnética.**

**Punta con espejo para visión lateral.**



2560x1920  
1280x720  
640x480

SMP

- Resolución: **2560x1920 / 1280x720 (720p 16:9) / 640x480 (480p 4:3).**
- Fotogramas: **20fps.**
- Pixel: **5,0mp.**
- Ángulo de visión: **70 grados.**
- Diámetro: **5,5mm.**
- Distancia focal: **4-6cm.**
- **6 LED** blancos ajustables.
- Resistencia al agua **IP67** (hasta 1 metro).
- Batería de litio **2600mAh.**



CABLE DE 1M SEMIRÍGIDO

Ø 5,5MM



FUNCIONA CON LA APP DE JBM:



App Store  
Google Play



VIDEOTUTORIAL DISPONIBLE EN

YouTube



## ENDOSCOPIO INDUSTRIAL CABLE 1m

**52436**  
1.170,00€

2,41 5 40  
Kg uB ft



- Alimentación: DC5.
- Monitor 3,5TFT 320x240px.
- Interfaz: MINI USB 1.1/AV.
- Batería: Recargable Li-Polymer 3.7V.
- Adaptador de corriente: 100-240V.
- AC en salida 5VDC.
- Video en NTSC&PAL.
- Almacenaje: CARD SD (hasta 32Gb).
- Compresión: JPG.
- Grabación: MPEG4 (640x480).
- Temperatura de trabajo: -20°C - 60°C.
- Temperatura almacenada: 0°C - 40°C.
- Diam. cable: 5mm.
- Funciones: salida de video, 6 idiomas, auto-off, fotos, videos.



PANTALLA EN COLOR

1M

RECAMBIO PUNTA PARA ENDOSCOPIO

**11992** 0,01 20  
65,00€ Kg ft

CABLE 3m

**11219** 0,32 1  
659,00€ Kg ft

CABLE 1m

**11329** 0,22 1  
564,00€ Kg ft

## DETECTOR DE FUGAS POR HUMO

**53484**  
615,00€

5 4 28  
Kg ft

- NO INCLUYE ACEITE.

275mm 220mm 235mm

12V 6 L/m 15PSI  
EVAP DUGH



ACEITE 500ML PARA REF. 53484  
**14081** 0,5 32 640  
12,55€ Kg ft

TUBO RECAMBIO PARA 53484

**14109** 20  
29,00€ ft

BOMBA INFLADOR PARA 53484

**14110** 1 70  
110,00€ ft

VIDEOTUTORIAL DISPONIBLE EN



Incluye:



## PISTOLA DE ADHESIVO TERMOFUSIBLE

**51831**  
21,00€

0,35 12 36 252  
Kg uB ft

- Voltaje: 100~ 230 V.
- Temperatura: 190~230 °C.
- Consumo: 60~150 W.
- Ø de boquilla: 2.0~2.3 mm.
- Rango: 8 - 16g de producto/min.



ADHESIVO TERMOFUSIBLE 10 unidades

**51859** 0,12 8 32 1.520  
3,80€ Kg ft

- Ø 8mm.
- Pega rápidamente todo tipo de materiales flexibles.
- Tiempo de secado: 20".

CE



## SOLDADORES

40W

100W

**53977** 0,30 12 48 576

14,50€



- Voltaje 220-240V
- 40W
- Frecuencia: 50Hz
- Largo: 240mm
- Cable: 1,3m
- Temperatura de trabajo máxima: 450°+/-10%



**53111** 0,28 5 25 500

17,00€



ESTAÑO

- Voltaje: 220-240V.
- Temp.: 420°C + / - 10%.
- Largo: 250mm.
- Cable: 1,5m.



## SOLDADORA INVERTER MMA

**53981** 3,35 1 90

119,00€



100A DC

- Adecuado para soldar en acero y hierro con todo tipo de electrodos ácidos y básicos.
- Tamaño pequeño, peso ligero y ahorro de energía.
- Buen arranque y fuerza del arco, arco estable y pocas salpicaduras.
- Alta calidad de soldadura, penetración profunda.
- Protección automática de sobretensión, sobrecorriente y sobrecalentamiento.
- La tecnología IGTB mejora enormemente la fiabilidad.
- Puede equilibrarse automáticamente cuando la tensión de entrada fluctúa.



- ✓ TECNOLOGÍA INVERTER IGTB
- ✓ MMA DC
- ✓ ANTI STICK
- ✓ ARC FORCE
- ✓ HOT ARC START

- Incluye:
- Portaelectrodo con cable de 2m.
- Pinza de masa para soldadura con cable de 1.5m.
- Máscara protectora facial.
- Martillo de soldadura con cepillo.



RECAMBIOS PARA REF. 53981

REF.	CARACTERÍSTICAS	€
15237	Portaelectrodo con cable de 2m	12,00€
15238	Martillo de soldadura con cepillo	5,00€
15239	Máscara protectora facial	5,50€
15240	Pinza de masa para soldadura con cable de 1.5m	9,50€
15241	Placa base	65,00€
15242	Conector rápido negativo/positivo	2,50€
15243	Ventilador	4,00€
15244	Interruptor	2,00€

**53982** 6,10 1 33

214,50€



160A DC

- Ampliamente utilizado para tareas de soldadura en la decoración de interiores y en trabajos en lugares con un alto nivel de trabajo.
- Tamaño pequeño, calidad estable y duradera.
- Buen arranque, pocas salpicaduras y buena formación.
- La tecnología IGTB mejora enormemente la fiabilidad.
- Se pueden utilizar electrodos de rutilo y básicos.
- Alta tensión en vacío y gran fuerza de arco.
- Protección automática de sobretensión, sobrecorriente y sobrecalentamiento.
- Corriente de soldadura estable a pesar de la fluctuación de la tensión de entrada, puede equilibrarse automáticamente cuando la tensión de entrada fluctúa.



- ✓ TECNOLOGÍA INVERTER IGTB
- ✓ MMA DC
- ✓ ANTI STICK
- ✓ ARC FORCE
- ✓ HOT ARC START

- Incluye:
- Portaelectrodo con cable de 2m.
- Pinza de masa para soldadura con cable de 1.5m.
- Máscara protectora facial.
- Martillo de soldadura con cepillo.



RECAMBIOS PARA REF. 53982

REF.	CARACTERÍSTICAS	€
15238	Martillo de soldadura con cepillo	5,00€
15239	Máscara protectora facial	5,50€
15245	Pinza de masa para soldadura con cable de 1.5m	7,50€
15246	Placa base	108,00€
15247	Conector rápido negativo	2,50€
15248	Conector rápido positivo	2,50€
15249	Ventilador	5,00€
15250	Interruptor	4,50€
15251	Portaelectrodo con cable de 2m	15,00€

## PISTOLA DE CALOR 2000W

**53145**  
**38,50€**

1 5 165  
Kg fl

- 220V-240V.  
- 50Hz-60HZ.

- 2000W.  
- Temperatura de salida: 50-600°C.  
- Flujo de aire: 220-480L/min.  
- 2 opciones de temperatura: 300 y 600°C.



**53162**  
**56,00€**

0,9 5 165  
Kg fl

- 220V-240V.  
- 50Hz-60HZ.  
- 2000W.

- Temperatura de salida: 100-600°C.  
- Flujo de aire: 280-480L/min.



DIGITAL

## MÁQUINA PARA RALLAR NEUMÁTICOS

**52643**  
**478,35€**

POTENCIA MÁXIMA 350W



REGULABLE  
DIGITALMENTE

**11974**  
**1,80€/u.**

**11975**  
**1,80€/u.**

**11976**  
**1,80€/u.**

**11977**  
**1,80€/u.**

**11978**  
**1,80€/u.**

**11979**  
**1,80€/u.**

**11980**  
**1,80€/u.**

**11981**  
**1,80€/u.**

**11982**  
**1,80€/u.**

**11983**  
**1,80€/u.**

### RECAMBIOS

1,80€/u.

REF.	11974	11975	11976	11977	11978
TIPO CUCHILLA	R1	R2	R3	R4	R5
CUCHILLA REDONDA	mm	mm	mm	mm	mm
A	3	5	6	8	10
B	7	7	10	12	12
C	5	8	15	16	18
D	21	21	23	25	24

REF.	11979	11980	11981	11982	11983
TIPO CUCHILLA	W1	W2	W3	W4	W5
CUCHILLA CUADRADA	mm	mm	mm	mm	mm
A	3	5	7	9	11
B	7	7	10	12	12
C	5	6	10	13	15
D	21	21	22	24	23

## AMOLADORAS ELÉCTRICAS

450W

**53656**  
**187,50€**

11,05 1 50  
Kg fl



600W

**53657**  
**231,50€**

16,35 1 24  
Kg fl



250W

**53658**  
**98,50€**

6,95 1 58  
Kg fl



250W

**53659**  
**145,50€**

9,70 1 15  
Kg fl



Cubierta protectora

Protector ocular

Varilla de montaje

Protector ocular

Muela abrasiva para amolar en húmedo

Varilla de montaje

Perilla de fijación del soporte

Muela abrasiva

Cubierta protectora

Muela abrasiva

Contenedor de agua

Cubierta protectora

Muela abrasiva para amolar en seco

## BASE METÁLICA PARA AMOLADORA

**53660**  
**136,50€**

8,60 1 28  
Kg fl

- Altura: 790mm.  
- Medidas de la placa de fijación: 250x280mm.  
- Peso: 8kg.

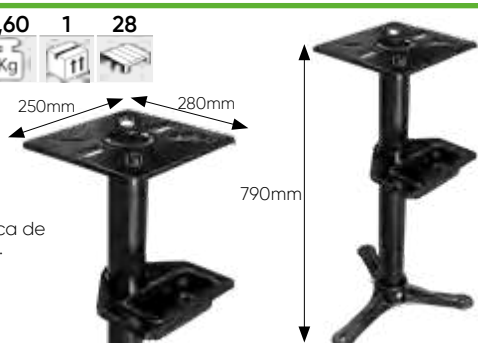

## AMOLADORA ELÉCTRICA 150mm

**52195**  
**170,00€**

7,08  
Kg  
1  
fl  
48

- Potencia nominal entrada: 250W.  
- Tensión nominal: 230V / 50Hz.  
- Velocidad sin carga: 2.950Rpm.  
- Ø de la rueda: 150 x 20 x 12.7mm.





## LIMPIADOR DE PIEZAS

**50632**

**327,00€**

24,3 1 6

**100L**

MEDIDAS TOTALES MÁQUINA

890mm 780mm 540mm

MEDIDAS INTERIORES DEPÓSITO

260mm 725mm 490mm



**52980**

**745,00€**

45 1 4

**150L**

MEDIDAS TOTALES MÁQUINA

890mm 1.090mm 520mm

MEDIDAS INTERIORES DEPÓSITO

270mm 1.060mm 490mm



- Caudal: 25L.  
- Funciona con soluciones limpias motores solubles en agua.

**PINCEL/BROCHA RECAMBIO**

**11100** 0,3 100  
**24,25€**

**BOMBA RECAMBIO**

**11101** 0,3 100  
**153,50€**

**FILTRO RECAMBIO**

**11102** 0,3 100  
**6,60€**

## LIMPIADOR DE PIEZAS PORTÁTIL

**53220**

**368,00€**

7,9 1 8

- FORMATO PORTÁTIL.

- Permite el cierre estanco para evitar pérdidas durante el transporte.

- Usar con disolvente de base acuosa.

- Interruptor de encendido lateral.

- Filtro de limpieza de líquido incluido.

- Colgador de herramientas y de manguera incluido.

- Compartimento de almacenamiento.

- Separación de áreas de trabajo, área de limpieza y área de secado, permite el trabajo con varias piezas a la vez.

- Capacidad máxima: 27,5L.

- Capacidad de bombeo: 1.000 L/h.

- Capacidad de trabajo: 20L.

- Conexión a 220V.

- Manguera de 1,10m de largo.



## ASPIRADORA INDUSTRIAL

**51837**

**195,00€**

8,25 1 9

**30L**

SECO DE 30L



**51838**

**734,00€**

28 1 2

**80L**

SECO + HÚMEDO 80L



	51837	51838
Capacidad (L)	30	80
Litros de aspiración por segundo (L/s)	26	50
Potencia motores	1x1.200W	3x1.000W
Voltaje	230V	230V
Frecuencia	50Hz	50Hz
Potencia de succión	> 17Kpa	> 20Kpa
Ø manguera	32mm	48mm
Largo manguera	1,5m	2m
Largo cable	4,5m	4,5m
Estanqueidad	IPx4	IPx4

INCLUYE



RECAMBIOS PARA REF. 51837

REF.	CARACTERÍSTICAS	€
10720	Manguera plástico 1,5m	24,50€
11095	Manguera plástico 3m	31,00€
10721	Tubo de metal extensible	19,00€
10761	Filtro	16,00€

INCLUYE



RECAMBIOS PARA REF. 51838

REF.	CARACTERÍSTICAS	€
10722	Manguera plástico 1,5m	24,50€
11098	Manguera plástico 6m	56,50€
10723	Codo superior	29,50€
10724	Codo inferior	29,50€
10762	Filtro	23,50€

## ROBOT ASPIRADOR

54020

3,4

4

85mm

350mm

350mm

288,00€

Kg

fl

Este robot inteligente realiza de forma automática tareas de **aspiración y fregado**. Gracias a su sistema de mapeo inteligente puede realizar una limpieza exhaustiva de la zona de trabajo. Es altamente configurable ya que le permite elegir entre diferentes modos de funcionamiento, ajustar niveles de aspiración y humedad y programar tareas para horas determinadas.



CONEXIÓN APP



4-5H 100-180min 14.8V 2600mAh



20W

3,4kg 68 dB 20cm/s 1200 Pa



Máxima superficie cubierta  
Maximum covered area  
**120m<sup>2</sup>**

Capacidad tanque de agua  
Water tank capacity

**300ml**

Capacidad del depósito de polvo  
Dust box capacity

**300ml**



CEPILLO LATERAL  
IZQUIERDO  
**15340** 100  
5,50€



CEPILLO LATERAL  
DERECHO  
**15341** 100  
5,50€



CEPILLO PRINCIPAL  
**15342** 100  
9,00€



FILTRO HEPA  
**15343** 100  
9,50€



CEPILLO DE LIMPIEZA  
**15344** 100  
6,50€

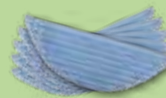

JUEGO DE 5 MOPAS  
**15345** 100  
10,50€

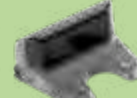

ESTACION BASE  
**15346** 30  
24,00€



TRANSFORMADOR  
DE CORRIENTE  
**15349** 20  
8,50€

## PULVERIZADOR INDUSTRIAL

53820

12,55

1

6

388,00€

Kg

fl

fl



310mm 1.160mm 260mm



3H



78 L/h

8kg



- ALTA EFICIENCIA:  
x7-10 veces mayor al pulverizador manual.

- BUENA DIFUSIÓN:  
ahorra agua y pesticida.

- DESINFECTA AMPLIAS COBERTURAS  
a través de finas partículas en forma de humo.

Capacidad del tanque	15L
Distancia de rociado	8-10m
Tamaño del líquido pesticida	<50 micras (µm)
Capacidad del depósito de gasolina	2L
Consumo de gasolina	3,2L/hora





# ROBOT CORTACÉSPED

52598

1.080,00€



- Robot autónomo cortacésped.  
- Fácil de almacenar e inalámbrico.

**5200 mAh**  
Capacidad de la batería  
Battery capacity

**1400m²**  
Superficie de corte  
Mowing area

**115,44W**  
Consumo de energía  
Power consumption

**AC 100-240V**  
50, 60Hz  
Tensión de entrada  
Input Voltage

**DC 15-25,5V**  
Tensión de salida  
Output Voltage

ALTURA DE CORTE:  
2,5 - 5,5CM

**2,5H**

**2H**

**70 dB**

**IP X4**

**7,5kg**

**22m/min**

50-35,5-24 cm

ANCHO DE CORTE:  
18CM



ESTACIÓN DE CARGA



VELOCIDAD DE GIRO DE LA CUCHILLA:  
3500RPM



REF.	CARACTERÍSTICAS		€
15424	Cable delimitador 150m	15	105,00€
15425	Grapas para cable delimitador 150pcs	15	50,00€
15426	Hoja de corte y tornillos	100	10,00€
15427	Clavos para estación de acoplamiento	50	9,00€
15428	Batería 22.2v, 2600mah	10	238,00€
15429	Cable de extensión 5m	10	23,50€
15430	Adaptador	10	83,00€
15431	Estación de carga	5	241,00€
15432	Conector de cable de conexión	10	18,50€
15433	Garaje	1	169,00€
15434	Rueda trasera y motor	5	147,00€
15435	Placa de la corte y placa de protección	5	24,50€
15436	Motor de corte	10	97,00€
15437	Placa base (función wifi)	5	305,50€
15438	Sensor de cable delimitador	10	31,00€
15439	Ruedas delanteras	10	52,00€



CONEXIÓN APP





# HIDROLIMPIADORAS DE ALTA PRESIÓN

Hidrolimpiadoras de alta presión con **motor de 1400W / 2400W** de potencia, ideales para limpiar bicicletas, vehículos y otros equipos de exteriores, así como patios, terrazas, invernaderos, etc.

**53947**

5,80 1 31  
Kg ft m

144,90€



## MOTOR

- 10  
Kg ft

- Presión de funcionamiento: 70 bar
- Flujo de funcionamiento: 5.5 L/min
- Presión máxima de entrada del agua: 4 bar
- Dimensiones: 28x25,5x44cm
- Tipo motor: escobillas de carbón

**15398**

74,50€

- Incluye:
- 1 pistola rociadora
- 1 manguera de alta presión de 3m
- 1 cable de alimentación de 5m



**53948**

12,10 1 10  
Kg ft m

323,50€



## MOTOR

- 10  
Kg ft

- Presión de funcionamiento: 120 bar
- Flujo de funcionamiento: 5.5 L/min
- Presión máxima de entrada del agua: 4 bar
- Dimensiones: 44x34,5x50,5cm
- Tipo motor: escobillas de carbón

- Incluye:
- 1 pistola rociadora
- 1 manguera de alta presión de 8m
- 1 cable de alimentación de 5m
- 1 boquilla turbo
- 1 conector de agua transparente
- 1 generador de espuma de 750ml
- 1 limpiador para patios
- 1 cepillo para llantas
- 1 cepillo fijo

**15399**

116,50€



## PISTOLA PULVERIZADORA

**15388** - 20  
33,00€ Kg ft

## BOQUILLA TURBO

**15393** - 100  
12,50€ Kg ft

## MANGUERA PVC DE 5M

**15389** - 20  
18,50€ Kg ft

## CAÑÓN DE ESPUMA

**15394** - 100  
26,00€ Kg ft

## LIMPIADOR DE SUPERFICIES DE 8 PULGADAS

**15390** - 12  
42,50€ Kg ft

## CONECTOR DE MANGUERA

**15395** - 50  
3,50€ Kg ft

## CEPILLO FIJO

**15391** - 50  
13,50€ Kg ft

## CEPILLO PARA LLANTAS

**15392** - 50  
17,50€ Kg ft



## CARRETE DE CABLE ELÉCTRICO - 21m

**53585**

168,00€



CON SOPORTE DE PARED

230V

1000W  
3000W

H07RN-F  
3G1.5mm<sup>2</sup>

IP  
44

20 m + 1m

**53586**

158,00€



DIFERENCIAL PROTECCIÓN DE SOBRECARGA



CE



SOPORTE DE PARED

0,35 10 **14771**  
10,50€

CON REPARTIDOR



## CARRETE DE CABLE ELÉCTRICO - 12M

**53584**

108,00€



CON SOPORTE DE PARED

230V

1000W  
3000W

H07RN-F  
3G1.5mm<sup>2</sup>

IP  
44

11 m + 1m

**53526**

118,00€



CE



SOPORTE DE PARED

0,40 10 **14774**  
10,50€

CON REPARTIDOR



DIFERENCIAL PROTECCIÓN DE SOBRECARGA



BLOQUEADOR DE CABLE



## CARRETE DE CABLE ELÉCTRICO

**51033**

98,00€



- Protección de sobrecarga.  
- Protección infantil.



## EXTENSIÓN DE CABLE DE CORRIENTE

**53166**

10,50€



3m

**53167**

12,50€



5m

**53168**

19,00€



10m



## VENTILADOR PARA VEHÍCULO 12V

**53543**

13,80€

197

1

2



## VENTILADOR DE COCHE DOBLE

**53600**

13,80€

0,55

5

20

160



**53601**

18,00€

0,65

5

20

120



## COMPRESOR DE AIRE PORTÁTIL

**53150**

22,50€

0,55

10

40

480



120mm

165mm

55mm

- Aplicar a los coches: turismo, SUV, etc.



## VENTILADORES

230V  
120W

50Hz

rpm / min  
1050 / 1150 / 1300  
x3 speed  
CFM  
2700 / 3000 / 3400

DE PIE

**53189**

99,00€

7,1

1

12



1.325mm

480mm

∅ 565mm

DE SUELO

**53190**

98,00€

6,1

1

16



1575mm

230mm

∅ 620mm



## ADAPTADOR DE ENCHUFE USB

**13839**

8,50€

0,08

200



110V / 60HZ



USB





ESTACIÓN DE ENERGÍA PORTÁTIL



282

PANEL SOLAR



282

COCHE ELÉCTRICO



283

DISTANCIA DE SEGURIDAD



284

ALTA TENSIÓN



284



# ENERGÍA RENOVABLE Y MOBILIDAD DEL FUTURO



# ESTACIÓN DE ENERGÍA PORTÁTIL 1920WH

53970

34,70 1 13

3.790,00€



La central eléctrica portátil es un generador eléctrico portátil de gran capacidad que se recarga con energía solar, pero también puede recargarse en cualquier toma de corriente, en ausencia de luz solar.



Solida nominal de CA Rated AC output <b>3000W</b>	Carga rápida Fast Charging <b>54V/10A 3-4h</b>	Carga solar Solar Charging <b>54V/7.5A 4-5h</b>	<b>220VAC</b> ± 10%
Pico de salida de CA Peak AC output <b>6000W</b>			
Ciclo de carga de la batería Battery life cycles <b>x2000</b>	LiFePO4	Temperatura de descarga Discharging Temperature -10°C ~ -60°C	Temperatura de carga Charging Temperature 0°C ~ 45°C
USB-GC 5V/9V/ 12V/3A	DCx2 12V/10A	USB-Type-C 5V/3A/9V/ 2A/12V/1.5A	USB 5V 2.4A*2
CC-CA	MPPT	383mm	427mm
		244mm	



INCLUYE:



Cargador de batería



Cargador placa solar



Cable conector cargador de pared

GENERADOR DE ENERGÍA PORTÁTIL

ENERGÍA EN CUALQUIER PARTE

AMPLIA GAMA DE APLICACIONES



<b>3000W</b> +0,75h	<b>2000W</b> +1h	<b>1500W</b> +1h	<b>1000W</b> +1,5h	<b>120W</b> +12h
<b>200W</b> +7,5h	<b>70W</b> +22h	<b>30WH</b> +50 veces	<b>10WH</b> +150 veces	<b>100W</b> +15h
<b>20W</b> +75h	<b>2200W</b> +1h	<b>500W</b> +3h	<b>500W</b> +3h	<b>2000W</b> +1h

COMPATIBLE CON **53971**

## PANEL SOLAR 200W

53971

13,45 2 12

350,00€



Abierto:

884mm 1320mm 54mm

Cerrado:

884mm 659mm 54mm

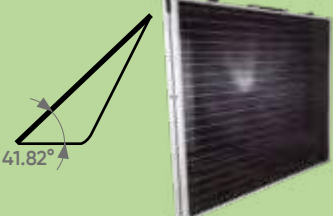

ALTA CONVERSIÓN DE ENERGÍA



### SET DE 2 CONECTORES

MC4 1000V 30A

15448

- 189

5,50€



FÁCIL DE TRANSPORTAR

FÁCIL INSTALACIÓN

## PANEL SOLAR 535W

54062

28,5 31

585,00€



535W

2256mm 1133mm 35mm

### ESPECIFICACIONES MECÁNICAS

Tipo de celdas: Monocristalina (Tipo-P), 182x91mm  
Número de celdas: 144 (6x24)  
Número de Bus Bar por célula fotoeléctrica: 10 Bus Bar  
Vidrio: 3.2mm de alta transmisión, revestimiento antirreflejante

Cable de salida (conector incluido):  
Diámetro: 4.0mm2  
Longitud: 300/400mm (longitud personalizable)  
Caja de conexiones: IP68, 3 diodos de Bypass  
Conector: Compatible con MC4



### ESPECIFICACIONES ELÉCTRICAS STC

Potencia máxima: 535W  
Voltaje de circuito abierto: 49.6V  
Potencia máxima de voltaje: 41.8V  
Corriente de circuito corto: 13.60A  
Potencia máxima de corriente: 12.80A  
Eficiencia del módulo: 20.93%

### ESPECIFICACIONES DE FUNCIONAMIENTO

Voltaje máximo del sistema: 1000 V/1500V DC  
Temperatura de funcionamiento: -40~+85°C  
Capacidad máxima de los fusibles en serie: 25A

Carga de nieve, lado frontal: 5400Pa  
Carga de viento, parte trasera: 2400Pa  
Temperatura nominal de funcionamiento de la celda: 45°C±2°C  
Nivel de aplicación: Clase A



### ESPECIFICACIONES ELÉCTRICAS NOCT

Potencia máxima: 398W  
Voltaje de circuito abierto: 46.5V  
Potencia máxima de voltaje: 39.2V  
Corriente de circuito corto: 10.99A  
Potencia máxima de corriente: 10.15A

Contacta con nosotros en [solar@jbmcamp.com](mailto:solar@jbmcamp.com)

para obtener estudios, informes, presupuestos e información técnica.





# COCHE ELÉCTRICO



**Híbridos y eléctricos**

## CABLES DE CARGA

<b>54053</b> 248,00€	2,5 Kg	5 ft	<b>16A</b> 3.6 kW Tipo 1-2	Monofásico Single-Phase
<b>54054</b> 336,00€	3 Kg	5 ft	<b>32A</b> 7.5 kW Tipo 1-2	Monofásico Single-Phase
<b>54055</b> 268,00€	2,5 Kg	5 ft	<b>16A</b> 3.6 kW Tipo 2-2	Monofásico Single-Phase
<b>54056</b> 280,00€	3 Kg	5 ft	<b>16A</b> 11 kW Tipo 2-2	Trifásico Three-Phase
<b>54057</b> 298,00€	3 Kg	5 ft	<b>32A</b> 7.5 kW Tipo 2-2	Trifásico Three-Phase
<b>54058</b> 347,00€	3 Kg	5 ft	<b>32A</b> 22 kW Tipo 2-2	Trifásico Three-Phase

SAE J1772	IEC 62196-2

<b>IP 66</b>	<b>5m</b>	<b>-25°</b> <b>+55°</b>
--------------	-----------	----------------------------

## ESTACIÓN DE CARGA PORTÁTIL

<b>54059</b> 580,00€	3 Kg	5 ft	<b>16A</b> 3.68 kW Tipo 2-2	<b>IP 66</b>	<b>6m</b>	<b>-25°</b> <b>+55°</b>
-------------------------	---------	---------	-----------------------------------	--------------	-----------	----------------------------

## TARJETA RFID

<b>15460</b> 3,00€	0,52 Kg	500 ft
-----------------------	------------	-----------

## CARGADOR DE PARED

<b>-25°</b> <b>+55°</b>	<b>IP 66</b>
----------------------------	--------------

295mm  
195mm  
65mm

<b>52600</b> 884,00€	6 Kg	4 ft	<b>16A</b> 3.6 kW
<b>52903</b> 920,00€	7 Kg	4 ft	<b>16A</b> 11 kW
<b>52902</b> 904,00€	6 Kg	4 ft	<b>32A</b> 7.5 kW
<b>54052</b> 960,00€	7 Kg	4 ft	<b>32A</b> 22 kW

## POSTE DE PLÁSTICO PARA CADENA ESPECIAL ALTA TENSION

**53940**  
13,20€

0,55 6 96  
Kg U.S. U.S. U.S.

- De PVC.  
- Franjas amarillas y negras.



ESPECIAL SEÑALIZACIÓN ALTA TENSION

CADENA NO INCLUIDA

✓ Para un vallado sencillo, rápido y móvil de zonas interiores y exteriores con limitaciones.

✓ Sus colores contrastantes hacen la cadena altamente visible para restringir áreas de alta tensión.



BASE RELLENABLE DE AGUA O ARENA PARA UNA MEJOR FIJACIÓN

850mm



## ESLABÓN DE ENCAJE NEGRO

**53942**  
0,50€

0,01 50 5.000 75.000  
Kg U.S. U.S. U.S.



## CADENA DE PLÁSTICO

**53941**  
5,75€

0,30 40 600  
Kg U.S. U.S.

- Longitud: 5m  
- Eslabón: 6mm  
- Color: Amarillo / Negro



## CINTAS DE BALIZAMIENTO 200M

**53987**  
8,30€

0,59 40 560  
Kg U.S. U.S. U.S.

200M X 10cm



## PINZA AMPERIMÉTRICA

**52382**  
18,00€

0,23 5 50 1.600  
Kg U.S. U.S. U.S.



**52952**  
64,80€

0,26 5 50 1.500  
Kg U.S. U.S. U.S.



	52382	52952
DCB	600V	20V, 600V
ACB	600V	600V
DCA		200A
ACA	20A, 200A, 600A	200A
OHM	2KΩ, 200KΩ, 2MΩ	2000Ω

55mm

167mm

22mm

## MULTÍMETRO DIGITAL

**50942**  
24,00€

0,33 10 60 480  
Kg U.S. U.S. U.S.

CE

- Dígitos: 3 1/2.  
- Medición: 2.000.  
- Datos instantáneos.  
- Autoapagado.



- Indicador de batería.  
- Baterías de 9V.  
- Sonda de temperatura.  
- Temperatura de -40°C a 1000°C.

V AC	200mV, 2V, 20V, 200V, 1000V	A AC	20mA, 200mA, 20A
V DC	200mV, 2V, 20V, 200V, 750V	A DC	20mA, 200mA, 20A
Ω	200Ω, 2KΩ, 20KΩ, 200KΩ, 2MΩ, 20MΩ, 2000MΩ		
F	2nF, 20nF, 200nF, 2μF, 20μF, 200μF		

## HERRAMIENTAS ALTO VOLTAJE

VER PÁG. 33





ACCESORIOS DE TALLER 286



ORGANIZADORES 289



KIT EMERGENCIA 291

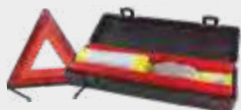

SENSORES DE APARCAMIENTO 293



ALFOMBRAS 298



ESCOBILLAS LIMPIAPARABRISAS 299



CONTRAPESAS 300



VALVULAS TPMS 301



PARA NEUMÁTICOS 302



TUBOS FLEXIBLES 306



# ACCESORIOS



## CARRETE DE MANGUERA DE AGUA

53872

134,00€

7,50

1

21



- Boca de 3/4".
- Con repartidor.
- Manguera de 15+1,5m.
- Diámetro de la manguera: 1/2"
- Diámetro interno: 11,5mm
- Diámetro externo: 15,8mm
- Presión de trabajo: 120 psi / 8 bar
- Material de la manguera: PVC.



CONECTOR DE MANGUERA RÁPIDO 1/2"

15153

0,1

50

2,50€

Kg

l

BOQUILLA DE RIEGO

15154

0,1

50

7,50€

Kg

l



## CARRETE DE MANGUERA DE AIRE

VER PÁG. 148

53582

178,50€



10,85



1



14

22M



53583

169,50€

53532

124,00€



6,2



2



30

13M



53581

107,50€

53881

69,00€



6,2



2



30

11,5M



53882

69,00€

## CARRETE DE CABLE ELÉCTRICO

VER PÁG. 279

53585

168,00€



8,35



2



34

21M



53586

158,00€

53526

118,00€



5,15



4



48

12M



53584

108,00€



## CARRETE DE MANGUERA PARA ACEITE

50797

490,00€

26,60

1

14



160 BAR

Soporte / carrete para aceite  
 Longitud de la manguera:  
 15+1 m  
 Presión máxima de trabajo:  
 2450 PSI  
 Entrada de aire: 1/2" BSPT  
 Salida de aire: 1/2" BSPT  
 Material: Acero





## ESCALERA TELESCÓPICA

**51982**

99,00€

5,51 1 40

↑ 2.000mm  
↓ 730mm

6 Peldaños

**51983**

149,00€

9,41 1 23

↑ 3.200mm  
↓ 930mm

9 Peldaños

**51984**

178,00€

10,78 1 21

↑ 3.800mm  
↓ 1.020mm

12 Peldaños

CUMPLE CON: EN 131

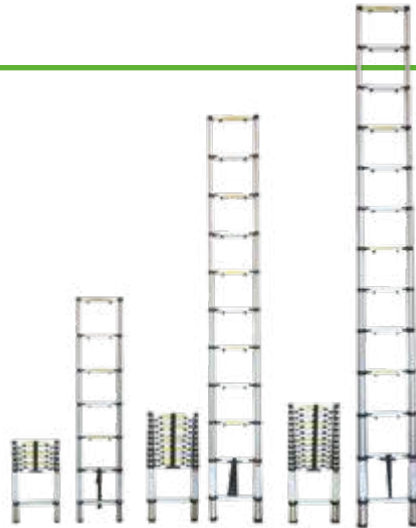

51982

51983

51984

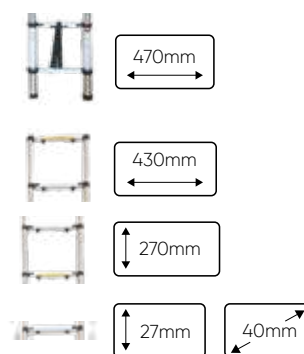

## ESCALERA TELESCÓPICA EN "V" PLEGABLE

**52149**

198,00€

13,97 1 13

- Escalera plegable y ligera.
- Sistema de plegado mediante bloqueo.
- Fabricada en aluminio y plástico.

- Altura plegada: 835mm.
- Altura extendida: 3800mm.
- Altura total: 1900mm.

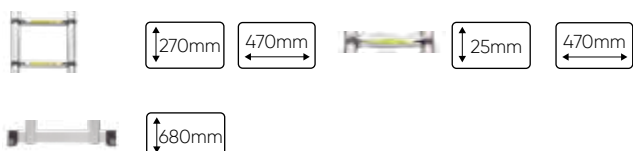

CUMPLE CON: EN 131



## ESCALERA DE ALUMINIO

**50517**

99,00€

4 1 18

- 4 PELDAÑOS
- Altura total: 1,30m.
- Altura máx. trabajo: 0,79m.



**50518**

128,00€

4,7 1

- 6 PELDAÑOS
- Altura total: 1,91m.
- Altura máx. trabajo: 1,31m.



## JUEGO DE 2 PLATAFORMAS DE ALUMINIO

**50656**

250,00€

10,45 1 12

100Kg

PLATAFORMAS DE ALUMINIO

**15552**

181,00€

↑ 550mm    1.300mm    ↗ 300mm

**11897**

155,00€

↑ 300mm    1.000mm    ↗ 300mm

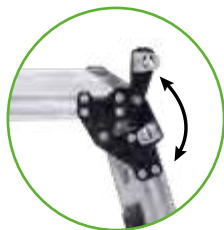

CUMPLE CON: EN 131

IVA no incluido



www.jbmcamp.com

287

ACCESORIOS DE TALLER

## PLATAFORMA DE ALUMINIO TELESCÓPICA

52230

16,75 1 14



295,00€



CUMPLE CON: EN 131

- Ancho de la plataforma 300mm.
- Largo de la plataforma cerrada: 1.090mm.
- Largo de la plataforma extendida: 1.750mm.
- Altura ajustable de la plataforma: 520-900mm.
- Ancho del peldaño: 40mm.
- Distancia entre peldaños: 250mm.

- Posiciones: 42 (14 de horizontales x 3 de verticales)  
 Altura 1: 520mm.  
 Altura 2: 700mm.  
 Altura 3: 900mm.

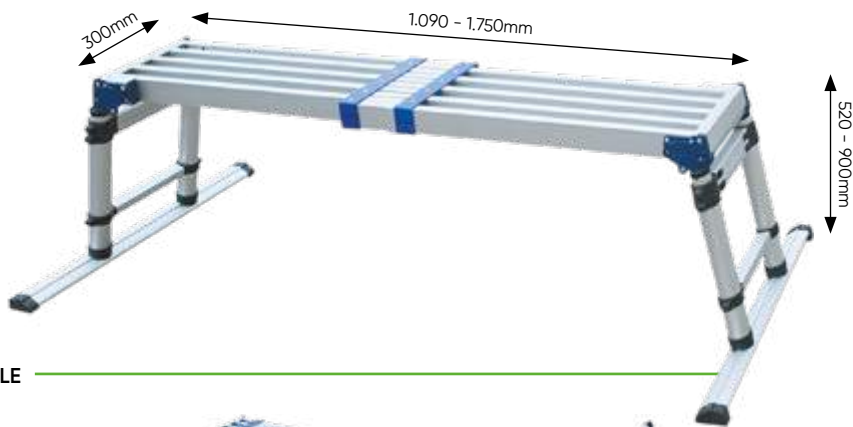

SUPER LIGERA



PLEGABLE



MONTAJE FÁCIL



PIE RECAMBIOS PARA PLATAFORMA REF. 52230

10966 0,06 1  
13,50€

TOPE DE ESCALÓN PARA PLATAFORMA REF. 52230

10965 0,01 1  
6,00€

PROTECTOR ESQUINA PARA PLATAFORMA REF. 52230

10964 0,01 1  
9,00€

## PLATAFORMA DE ALUMINIO GRANDE

50913

6,5 1 20



169,00€



800mm 1400mm 300mm

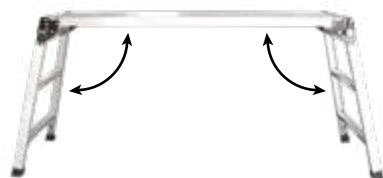

CUMPLE CON: EN 131



## CARRO DE ALUMINIO

52201

6,18 1 30



66,00€



EXTENDIDO

1.060mm 380mm 400mm

PLEGADO

700mm 400mm 200mm



PLEGABLE Y EXTENSIBLE



## CARRO DE ACERO BÁSICO

52202

9,35 1 10



80,00€



110mm 450mm 500mm



RUEDA MACIZA 3.00-4 (260x85) PARA REF. 52202

12055

1,11 10 160

20,00€





## CARRO DE PLATAFORMA DE ACERO

52200

88,00€



150Kg

EXTENDIDO

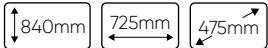

PLEGADO

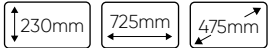

PLEGABLE



2 RUEDAS GIRATORIAS



## COFRE CON COMPARTIMENTOS

50958

38,00€



## ORGANIZADOR DE 5 COMPARTIMENTOS

51051

28,00€

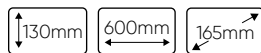

CAJONES INSEPARABLES

## ORGANIZADOR DE PIE 47 COMPARTIMENTOS

51050

195,00€

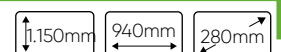

COMPARTIMENTOS PEQUEÑOS  
Total: 32  
Medidas: 16x10x7,5 cm  
Medidas del estante: 84x16x8 cm  
Total estantes: 4



- COMPARTIMENTOS GRANDES  
Total: 15  
Medidas: 24x14,5x13 cm  
Medidas del estante: 84x14x24 cm  
Total estantes: 3

## SET DE 8 CAJONES APILABLES CON GUÍA

50960

21,50€

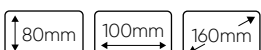

CAJONES



GUÍA



ORGANIZADORES

## CAJA 18+1 COMPARTIMENTOS

**50959**  
12,00€

0,7 16 128  
Kg fl

280mm 360mm 65mm

- 18 compartimentos de 6x7 cm.
- 1 compartimento de 35x7 cm.
- Abatible a 4 separaciones.



## CAJA 24+2 COMPARTIMENTOS

**50957**  
22,00€

1,13 12 48  
Kg fl

280mm 540mm 80mm

- 24 compartimentos de 8x5,5 cm.
- 2 compartimentos de 15x7,5 cm.
- Abatible de 26 a 5 separaciones.

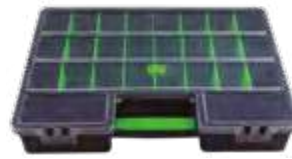

## BOLSA PLANA 550 x 150mm

**REF.** 0,05 100 3.200  
2,50€

Kg fl

53621 53623  
53622 53624

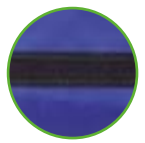

VELCRO

## BOLSA ROJA CON 1 COMPARTIMENTO 565 x 100 x 130mm

**51681**  
4,50€

0,17 100 700  
Kg fl

- En tela 'red' y con cierre de velcro.



VELCRO



## BOLSA NYLON VERDE ESPECIAL

470 x 65 x 140mm

**10945**  
2,30€

0,12 100 1.600  
Kg fl

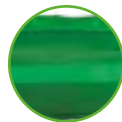

VELCRO

## BOLSA CON 6 COMPARTIMENTOS

570 x 100 x 130mm

**51680**  
2,40€

0,28 100 800  
Kg fl



VELCRO

- En tela 'red' y con cierre de velcro.  
- División central con 6 compartimentos.



## BOLSA CON RIBETE

550 x 90 x 130mm

**REF.** 0,12 100 1.100  
3,50€

Kg fl

51692 51694  
51693 51696



VELCRO

## BOLSA PARA KIT EMERGENCIA DE PVC

570 x 110 x 65mm

**51691**  
2,40€

0,18 100 1.200  
Kg fl



VELCRO

## GUANTES DE NITRILO, VINILO, PIEL, ALGODÓN...

VER PÁG. 308





# KIT DE EMERGENCIA Y SEGURIDAD

CONSULTE PRECIO POR CANTIDADES  
SERIGRAFÍA Y FOTOLITO NO INCLUIDOS



## KIT DE EMERGENCIA EN CAJA PLÁSTICA

**53540**  
23,00€



Personalizable a partir de **50 unidades**.

\* Doble triángulo, obligatorio solo en España.

## KIT DE EMERGENCIA BOLSA CON RIBETE



x1

**53177** 14,20€

**53178** 14,20€

**53179** 14,20€

**53180** 14,20€

x2

**53181** 21,70€

**53182** 21,70€

**53183** 21,70€

**53184** 21,70€

\* Doble triángulo, obligatorio solo en España.

## KIT DE EMERGENCIA BOLSA PVC



x1

**53185** 14,60€

x2

x2

**53186** 22,10€

\* Doble triángulo, obligatorio solo en España.

## KIT DE EMERGENCIA BOLSA CON RIBETE

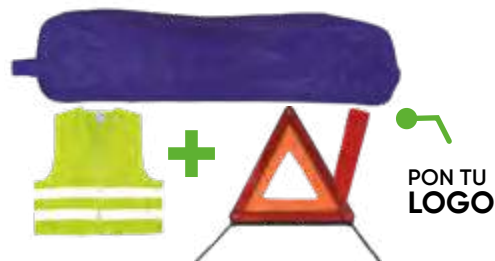

**53087** 13,50€

**53088** 13,50€

**53089** 13,50€

**53090** 13,50€

## KIT DE EMERGENCIA BOLSA PLANA



**53091** 14,00€

**53092** 14,00€

**53093** 14,00€

**53094** 14,00€

## KIT DE EMERGENCIA BOLSA PLANA

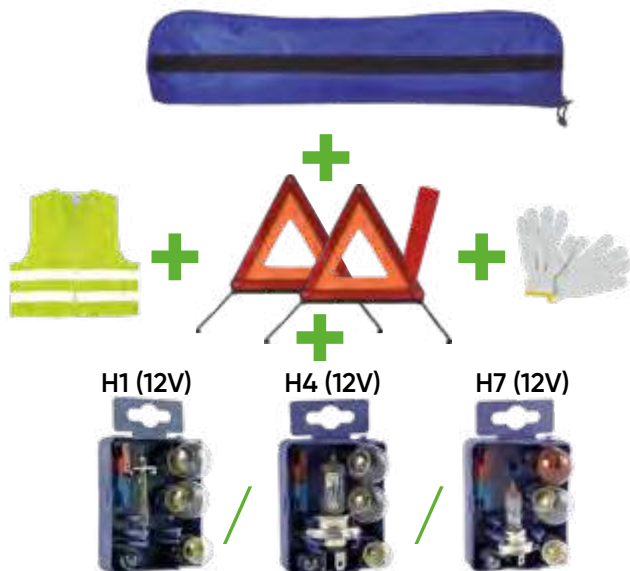

H1 (12V)



H4 (12V)



H7 (12V)



MK H1

Blue	52768	18,55€
Grey	52772	18,55€
Red	52776	18,55€
Black	52780	18,55€

MK H4

Blue	52769	20,50€
Grey	52773	20,50€
Red	52777	20,50€
Black	52781	20,50€

MK H7

Blue	52770	19,55€
Grey	52774	19,55€
Red	52778	19,55€
Black	52782	19,55€

MK H7+H1

Blue	52771	20,15€
Grey	52775	20,15€
Red	52779	20,15€
Black	52783	20,15€

\* Doble triángulo, obligatorio solo en España.

## BALIZA DE EMERGENCIA LED

53721

0,16 20 80 1.440

18,80€



MODOS DE LUZ

- Incluye 2 modos de luz:  
destello de emergencia naranja  
+ función de iluminación con luz  
blanca.

+INFO PÁG. 111

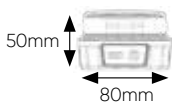

Amplia  
visibilidad



Magnético



Pequeño,  
ligero y fácil  
de manejar

## TRIÁNGULO DE SEÑALIZACIÓN HOMOLOGADO

53778

0,35 40 1.440

4,50€



x1



52795

0,59 20 980

6,00€



x1



## CHALECO REFLECTANTE HOMOLOGADO

51817

0,13 100 2.600

4,50€



50654

0,13 100 2.600

4,00€



50966

0,13 100 2.600

4,00€



Banda marcada

CUMPLE CON: EN ISO20471:2013





# KIT REPARAPINCHAZOS LÍQUIDO Y COMPRESOR DE AIRE

<b>54013</b>	1,15	5	20	240
29,00€				

- Sella pinchazos de hasta 6mm.
- Añadiendo el líquido una sola vez en el neumático, se pueden evitar hasta 60 pinchazos.
- Material no corrosivo para metales ni gomas.
- No inflamable y anticongelante, de gran durabilidad.

## LÍQUIDO SELLADOR DE PINCHAZOS - 500ML

<b>15300</b>	0,55	12
5,00€		



## EXTRACCIÓN OBUSES

<b>11960</b>	0,01	10	500
1,50€			



## BOLSA PARA KIT

<b>15317</b>	0,01	500
4,50€		



## COMPRESOR DE AIRE PORTÁTIL 12V 100W

<b>53150</b>	0,55	10	40	480
22,50€				



## PONCHO IMPERMEABLE

<b>50525</b>	0,05	250	6.250
1,00€			



## PISTOLA PLÁSTICA PARA BOTE DE SPRAY

<b>52493</b>	0,06	24
4,50€		

- Útil accesorio para utilizar con la mayoría de sprays del mercado.



## SPRAY REPARA PINCHAZOS

<b>51814</b>	0,03	12	1.320
7,99€			

- Para arreglar el pinchazo en menos de un minuto sin necesidad de cambiar la rueda ni desmontarla.



300ml

## RASQUETA QUITAHELO

<b>51697</b>	0,03	300	7.500
0,50€			



## PARAGUAS PLEGABLE

<b>50526</b>	0,2	100	2.000
4,50€			



## TIJERAS MINI DE 9 cm

<b>51925</b>	0,01	100	1.000	40.000
1,00€				



## MARTILLO ROMPELUNAS CON SOPORTE Y CORTACINTURÓN

<b>52259</b>	0,16	50	100	2.000
3,50€				



135mm	20mm
75mm	∅160mm

## SOPORTE MÓVIL COCHE PARA REJILLAS DEL AIRE

<b>53443</b>	0,05	100
7,00€		



55mm - 83mm

ENGANCHE

## ADAPTADOR USB PARA TOMA DE MECHERO

<b>13815</b>	0,06	10	100
8,50€			

- Voltaje entrada: 12-24V.  
- Voltaje salida: 5V (1.000mA).



KIT EMERGENCIA

## LINTERNA DINAMO DE 2 LEDS

51573  
2,50€

0,07 12 96 3.456  
Kg Utl Utl Utl

6 Lm X2 LED



PRESENTACIÓN EN CAJA INDIVIDUAL



## LINTERNA DINAMO DE 3 LEDS

51446  
2,50€

0,08 12 96 3.456  
Kg Utl Utl Utl

10 Lm X3 LED



EN EXPOSITOR DE 12 UNIDADES

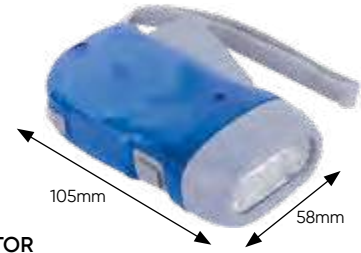

## BOLSAS DE PVC CON CREMALLERA

14918  
0,20€

0,01 2.400 38.400  
Kg Utl Utl

25 x 30cm

14919  
0,50€

0,01 1.500  
Kg Utl

60 x 18 cm



## SET ORGANIZADOR DE MALETERO MULTIFUNCIONAL

52618  
52,00€

2,03 6 36  
Kg Utl Utl

- Set compuesto de 4 piezas:
- Cofre flexible 37L con tapa (300mm x 490mm).
- Bidón circular con tapa Ø 180mm (230mm altura).
- Colgador porta objetos sin tapa (90mm altura x 260mm largo).
- Bandeja rígida (175mm altura x 300mm largo).



## SET DE 3 GAMUZAS DE MICROFIBRA

53221  
4,75€

0,03 50 800  
Kg Utl Utl

360mm 360mm

3 PCS

- Set de 3 gamuzas de microfibra, material 100% poliéster de alta calidad.
- Ideales para la limpieza en general (quitar el polvo, desengrasar, repasar pulido...).
- Gran capacidad de absorción de líquidos.
- Sin dejar hilos residuales.



IDEALES PARA LA LIMPIEZA GENERAL DE CUALQUIER VEHÍCULO



MÚLTIPLES APLICACIONES

GRAN CAPACIDAD DE ABSORCIÓN DE LÍQUIDOS





## BOTIQUÍN DE PRIMEROS AUXILIOS DIN13164

54042

0,41

10

13,00€



Botiquín pequeño y manejable, ideal para coche y transportarlo con facilidad, presentado en bolsa con cierre cremallera y velcro en la parte posterior.



Contiene:

- 1 Esparadrupo en bobina DIN 13019-A 5x2,5
- 1 Set de 14 unidades que incluye:
  - 4 Vendas adhesivas DIN 13019-E 10x6
  - 2 Tiritas para dedos elásticas 4cmx7cm
  - 2 Tiritas para dedos elásticas 12cmx2cm
  - 2 Tiritas resistentes al agua 1,9x7,2cm
  - 4 Tiritas resistentes al agua 2,5x7,2cm
- 1 Venda esterilizada DIN 13151-K 6x8cm
- 2 Vendas esterilizadas DIN 13151-M 8x10cm
- 1 Venda esterilizada DIN 13151-G 10x12cm
- 1 Paño para heridas DIN 13152-BR 60x40cm
- 1 Paño para heridas DIN 13152-A 60x80cm
- 2 Vendas esterilizadas DIN 61634FB6 6cmx400cm
- 3 Vendas esterilizadas DIN 61634FB8 8cmx400cm
- 1 Manta de primeros auxilios 160x210cm
- 6 Compresas esterilizadas 10x10cm
- 2 Vendajes triangulares DIN 13168-D
- 1 Tijera DIN 58279-A145 145cm
- 4 Guantes desechables DIN EN 455-1
- 2 Toallitas limpiadoras para limpiar la piel
- 1 Listado de contenido
- 1 Guía de primeros auxilios

## BOTIQUÍN DE PRIMEROS AUXILIOS DIN13157

54072

1,6

10

38,50€



Este botiquín de pared incluye los anclajes necesarios para colgarlo en la pared.

Contiene:

- 1x Esparadrupo adhesivo 5x25 - DIN13019-A
- 1x Set de vendas de esparadrupo 10x6cm (8 piezas) - DIN13019-E
- 4x Esparadrupo para dedos 4cmx6,5cm
- 4x Esparadrupo para dedos 120x20mm
- 4x Esparadrupo para dedos 72cmx1,9cm
- 8x Esparadrupo para dedos 25x72 mm
- 1x Vendas de primeros auxilios, compresa estéril 6x8cm - DIN13151-K
- 3x Vendas de primeros auxilios, compresa estéril 8x10cm - DIN13151-M
- 1x Vendas de primeros auxilios, compresa estéril 10x12cm - DIN13151-G
- 1x Compresa estéril (apósitos para quemaduras) 60x80cm - DIN13152-A
- 3x Apósitos estériles para heridas (compresa) 100mm x100mm 2pcs/bolsa - DIN58953-2
- 2x Compresa ocular - 55mmx75mm 1,5g
- 1x Compresa fría instantánea min.200cm2
- 1x Manta de primeros auxilios 160cmx210cm 12 micras
- 2x Vendajes elásticos en cumplimiento del estándar (gasas) 6cmx400cm - DIN61634 FB6
- 2x Vendajes elásticos en cumplimiento del estándar (gasas) 8cmx400cm - DIN61634 FB8
- 2x Vendajes triangulares 96x96x136cm DIN13168-D
- 1x Tijeras de metal 190mm - DIN58279-B190
- 2x Bolsa de plástico para basura 300x400mm 45 micras
- 5x Malla no tejida 20cmX30cm min.15g/m2
- 1x Guantes desechables PVC L-AQL1.5 (juego de 4 piezas) - DIN EN 455-1
- 1x Folleto informativo
- 2x Mascarillas quirúrgicas DIN EN 14683
- 4x Toallitas de limpieza para piel sana



## CINTURÓN DE SEGURIDAD PARA AUTOCARES

CINTURÓN DE 2 PUNTOS

CUMPLE CON:  
E4-16R-0436213

50644

0,40

40

1.600

11,60€



1250mm

CINTURÓN DE 2 PUNTOS ENROLLABLE

CUMPLE CON:  
E4-16R-0436232

50717

0,75

20

500

21,00€



1330mm

CINTURÓN DE 3 PUNTOS ENROLLABLE

CUMPLE CON:  
E4-16R-0436232

51266

1,13

20

320

27,60€



2900mm



## BOTIQUÍN DE PRIMEROS AUXILIOS

51246

0,2

50

600

6,40€



- Contiene:
- 1 Folleto primeros auxilios
- 1 Tijeras
- 1 Par de guantes de látex
- 2 Toallitas de alcohol
- 2 Tiritas adhesivas
- 25g de algodón
- 1 Sobre con 5 gasas 20x20cm
- 1 Venda
- 1 Rollo de esparadrupo



## DISTINTIVO PARA VEHÍCULOS DE TRANSPORTE DE MERCANCÍAS

51935

1,04

10

280

198,00€



51936

1,04

10

140

198,00€



51937

1,03

10

280

198,00€



50mm

50mm



HOMOLOGACIÓN:  
REGLAMENTO CEPE/ONU 104R

IVA no incluido



www.jbmcamp.com

295

KIT EMERGENCIA



## PLACA CARGA SOBRESALIENTE HOMOLOGADA V-20

- Placa para cargas que sobresalen por la parte trasera de cualquier vehículo: camión / furgoneta / turismo / ...  
- Con homologación V20.

- Señalización obligatoria en toda Europa para un transporte seguro.  
- Medida: 500x500mm.

**53636**

18,00€

0,45 5 25 750



FABRICADA EN POLIPROPILENO PARA UNA MAYOR FLEXIBILIDAD



**53507**

24,00€

0,75 5 25 750



PARTE DELANTERA HECHA DE POLIMETILMETRACRILATO (PMMA) Y PARTE TRASERA DE ALUMINIO

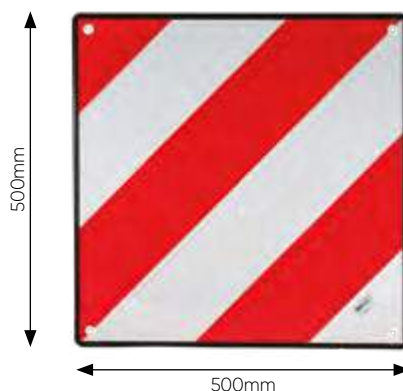

## CUÑA DE PLÁSTICO PARA BLOQUEAR RUEDAS

**53561**

28,00€

1,65 4 72



1 PCS 30T

- De color amarillo intenso para detectarlo visualmente de manera fácil y rápida cuando se está utilizando.

- **Peso ligero:** fácil de transportarlo y manejarlo.

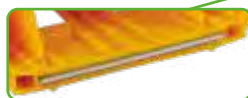
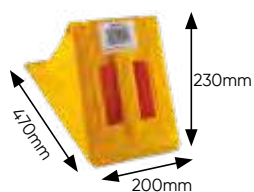

Con una **tira de hierro** en la parte inferior que **evita el deslizamiento** cuando sobre el pavimento hay hielo o arena.



SOPORTE PARA CUÑA DE PLÁSTICO

**14118**

26,00€

1,25 4 72



## SET DE 2 CALZOS PARA VEHÍCULO

**53508**

14,00€

0,35 4 24 288



2 PCS 1T



## PLACA PORTAMATRÍCULA ANÓNIMA

**51412**

2,00€

0,09 100 3.600



- Dimensiones : 53,20cm x 13,70cm.  
- Area de marcado: 52cm x 1,60cm.  
FOTOLITO Y SERIGRAFÍA NO INCLUIDO





## PALA PLEGABLE

51858

0,96 20 320

15,00€



- Fabricada con metal resistente.
- Plegada: 240mm.
- Desplegada: 600mm.



## PALA EXTENSIBLE ALUMINIO

53033

0,63 5 65

15,50€

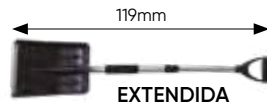

EXTRAÍBLE

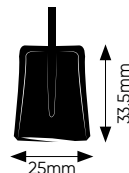

## CUERDA MULTIUSOS 30M

53964

0,70 5 20 240

10,50€



Ø 1/4"



53965

1,85 5 10 120

29,00€



Ø 1/2"



30M



## SENSOR DE APARCAMIENTO CON MEDIDOR DE APROXIMACIÓN VISUAL Y ACÚSTICO

51863

0,63 5 20 200

54,00€



- Voltaje nominal: DC 12 V.
- Potencia: 3,6 W.
- Temperatura de trabajo: -20° a 70°.
- 4 sensores de aproximación.
- Distancia de detección: 0,3-2,0 m.
- Ángulo de detección: H>60°, V>60°.
- Radiofrecuencia: 315 MHz / 433 MHz.
- Incluye indicador de 2 colores de marcado de aproximación.
- Sensores de color negro (no repintables).



## SENSOR DE APARCAMIENTO CON MEDIDOR DE APROXIMACIÓN ACÚSTICO

51973

0,54 5 20 240

44,50€



- Voltaje nominal: DC 12 V.
- Potencia: 3,6 W.
- Temperatura de trabajo: -20° a 70°.
- 4 sensores de aproximación.
- Distancia de detección: 0,3-2,0 m.
- Ángulo de detección: H>60°, V>60°.
- Radiofrecuencia: 315 MHz / 433 MHz.
- Sin indicador visual.
- Incluye zumbador de Ø 4cm.
- Sensores de color negro. No repintables.

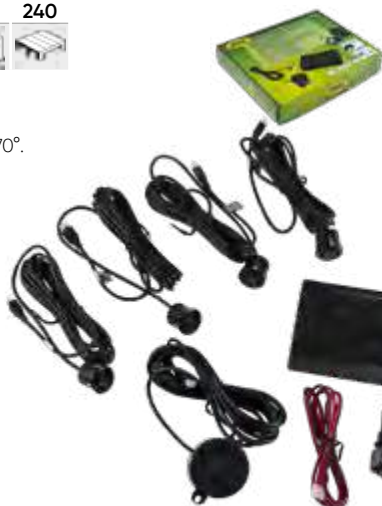

## SENSOR DE PÁRQUING DE ALARMA 8 PINS

52742

0,91 5 20 120

64,00€



x8

- Delantero + trasero.
- Señal acústica.
- 4 sensores traseros.
- Resistente a lluvias y mal tiempo.
- Piezas de repuesto disponibles.
- Pins repintables.



## ALFOMBRA DE GOMA UNIVERSAL REVERSIBLE

**50585**

2,86 8 208

14,70€



- Goma de alta calidad.
- Muy resistente.
- Adaptable a la mayoría de vehículos.



**iREVERSIBLE!**



EXPOSITOR ALFOMBRAS

**METEXP**  
57,00€



## ALFOMBRA DE GOMA UNIVERSAL

**53241**

1,65 12 288

9,00€

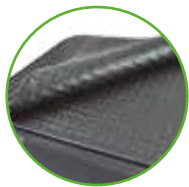

- Goma de alta calidad.
- Muy resistente.
- Adaptable a la mayoría de vehículos.



EXPOSITOR ALFOMBRAS

**METEXP**  
57,00€



## JUEGO DE ALFOMBRAS DE MOQUETA

**52530**

2 8 160

16,00€



- 2 Delanteras (390mm).
- 2 Traseras (365x480mm).
- Ligera, confortable, con talonera plástica.
- Reverso con tacos de goma antideslizante.



EXPOSITOR ALFOMBRAS

**METEXP**  
57,00€



REVERSO



## JUEGO DE ALFOMBRAS DE MOQUETA

### TALONERA COLOR ALUMINIO

**52534**

1,55 8 160

16,00€



- 2 Delanteras (425x660mm).
- 2 Traseras (295x425mm).
- Ligera, confortable, con talonera plástica.
- Reverso con tacos de goma antideslizante.



52534



52535



### TALONERA MOQUETA

**52535**

1,55 8 160

16,50€



EXPOSITOR ALFOMBRAS

**METEXP**  
57,00€





# ESCOBILLA DE LIMPIAPARABRISAS



**FÁCIL  
INSTALACIÓN**

**GRAN PODER LIMPIADOR  
A GRAN VELOCIDAD**

**99%**

Fácil instalación de los adaptadores en más del 99% de los vehículos y gran poder limpiador a alta velocidad.

**38dB**

La ergonomía y la eliminación de partes de peso reduce el ruido en 38db.

**30%**

Presión uniforme a largo de la escobilla gracias al muelle de acero para una mayor visibilidad que las escobillas originales y un rendimiento superior del 30%.

**100%**

Caucho 100% natural resistente a todas las condiciones climáticas extremas.

**160km/h**

Diseño aerodinámico que permite un uso hasta 160km/h.

**45°**

45° de ángulo de corte y precisión de limpieza transversal que elimina las gotas más pequeñas.



**11 ADAPTADORES  
DIFERENTES:  
PARA APLICACIONES MÚLTIPLES**



REF.	DESCRIPCIÓN	1	2	3	4	5	€
53745	11" 280mm	0,20	10	50	800		6,00€
53746	12" 310mm	0,20	10	50	800		6,50€
53747	13" 330mm	0,20	10	50	600		6,50€
53748	14" 350mm	0,20	10	50	800		6,50€
53749	15" 380mm	0,20	10	50	800		6,50€
53750	16" 410mm	0,20	10	50	800		6,50€
53751	17" 430mm	0,20	10	50	550		7,00€
53752	18" 460mm	0,25	10	50	800		7,00€
53753	19" 480mm	0,25	10	50	600		7,00€
53754	20" 510mm	0,25	10	50	600		7,50€
53755	21" 530mm	0,25	10	50	600		7,50€
53756	22" 560mm	0,25	10	50	700		8,00€
53757	24" 610mm	0,25	10	50	550		8,50€
53758	26" 650mm	0,30	10	50	550		8,50€
53759	28" 700mm	0,30	10	50	550		8,50€
53760	30" 750mm	0,30	10	50	500		9,50€



**12  
PCS**

## EXPOSITOR

JBMWBEXP

1,07 10 100

24,50€



ESCOBILLAS  
LIMPIAPARABRISAS

JBM

## CONTRAPESAS AUTOADHESIVAS EN PASTILLAS DE 45 g. (TIRAS DE 5g - 10g - 5g - 10g - 5g - 10g)

**50600** 0,05 100 400 16.000  
0,70€      
ZINC

**50600**

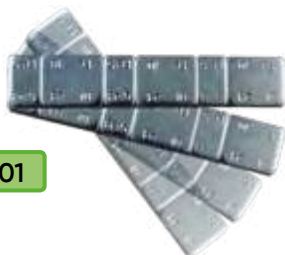

**50601**

**50601** 0,05 100 400 38.400  
0,35€      
HIERRO

## ALICATE ESPECIAL PARA CONTRAPESAS

**51355** 0,05 5 50 500     

- Extrae fácilmente y sustituye la contrapesa.
- Corta y dobla con facilidad
- Hecho de acero reforzado al calor.
- Incluye mango ergonómico.
- Con muelle automático en abierto en el asa para facilitar su operación.



## CONTRAPESAS ADHESIVAS 60 g.

**52665** 0,35€ **52666** 0,35€

5gr x 12 u.

5gr x 4 u.

10gr x 4 u.

- Hierro
- Adhesivo de gran agarre y larga duración.



**52665**

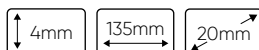

 0,06  
 100  
 400  
 33.200







**52666**







 0,06  
 100  
 400  
 30.000

## CONTRAPESA DE GRAPA EN ZINC ESPECIAL LLANTA UNIVERSAL

REF.	g.						€
50760	5g.	0,01	100	1.600	20.000	20.000	0,09€
50761	10g.	0,01	100	1.600	29.600	29.600	0,18€
50762	15g.	0,02	100	800	29.200	29.200	0,26€
50763	20g.	0,02	100	800	30.000	30.000	0,35€
50764	25g.	0,03	100	800	30.000	30.000	0,44€
50765	30g.	0,03	100	600	20.000	20.000	0,51€
50766	35g.	0,04	100	400	10.000	10.000	0,61€
50767	40g.	0,04	100	400	12.400	12.400	0,70€
50768	45g.	0,05	100	400	2.250	2.250	0,79€
51055	50g.	0,05	100	400	2.000	2.000	0,85€



## CONTRAPESA DE GRAPA EN ZINC ESPECIAL LLANTA ALEACION

REF.	g.						€
50778	5g.	0,01	100	1.600	20.000	20.000	0,09€
50779	10g.	0,01	100	1.600	10.000	10.000	0,18€
50780	15g.	0,02	100	1.200	6.600	6.600	0,26€
50781	20g.	0,02	100	800	5.000	5.000	0,35€
50782	25g.	0,03	100	800	4.000	4.000	0,44€
50783	30g.	0,03	100	600	3.300	3.300	0,53€
50784	35g.	0,04	100	400	2.850	2.850	0,61€
50785	40g.	0,04	100	400	2.500	2.500	0,70€
50786	45g.	0,05	100	400	2.250	2.250	0,77€
51604	50g.	0,05	100	400	2.000	2.000	0,75€







## CONTRAPESA UNIVERSAL CAMIÓN

### SEGMENTACIÓN DE 50G

**52667** 0,05 50 400 25.600  
0,64€    



### SEGMENTACIÓN DE 100G

**52668** 0,1 25 200 12.800  
1,21€    







### SEGMENTACIÓN DE 150G

**52669** 0,15 20 160 10.240  
1,80€    







### SEGMENTACIÓN DE 200G

**52670** 0,2 10 80 5.120  
2,50€    







### SEGMENTACIÓN DE 250G

**52671** 0,25 10 80 5.120  
2,97€    



### SEGMENTACIÓN DE 300G

**52672** 0,3 10 80 5.120  
3,56€    





## DISPENSADORES DE CONTRAPESAS AUTOADHESIVAS - PASTILLA DE HIERRO DE 5g

- 1.000 pastillas de 5g de contrapesa de hierro. / Autoadhesiva con 4 mm de espesor. / Medidas del dispensador: 29,5 cm x 29,5 cm.

**51908**

5,82 4 204

44,00€



**53256**

34,00€

5,3  
4  
216

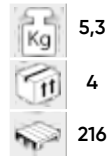

Con imán de retención de sobrantes

## ESTUCHE DE CONTRAPESAS SURTIDO

**53864**

10,50 1 71

138,00€



CONTRAPESAS ADHESIVAS

60gr: 4x10gr 4x5gr - 70u. (ref. 52666)

CONTRAPESAS DE ZINC CON GRAPA

LLANTA UNIVERSAL

LLANTA ALEACIÓN

5g - 20 uds (ref. 50760)

5g - 20 uds (ref. 50778)

10g - 20 uds (ref. 50761)

10g - 20 uds (ref. 50779)

15g - 20 uds (ref. 50762)

15g - 20 uds (ref. 50780)

20g - 20 uds (ref. 50763)

20g - 20 uds (ref. 50781)

25g - 20 uds (ref. 50764)

25g - 20 uds (ref. 50782)

30g - 10 uds (ref. 50765)

30g - 10 uds (ref. 50783)

35g - 10 uds (ref. 50766)

35g - 10 uds (ref. 50784)

40g - 10 uds (ref. 50767)

40g - 10 uds (ref. 50785)



80mm

540mm

280mm

## VÁLVULAS TPMS

**12902**

0,01 4 100

5,70€



4.25 Nm

OE 72-20-223



**12908**

0,01 4 100

5,70€



OE 72-20-205,  
TPK65654

4.25 Nm



**12910**

0,01 4 100

5,70€



OE 72-20-206,  
TPK65655

7.5 Nm



**12915**

0,04 4 100

15,50€



1.4 Nm (screw)

8 Nm (nut) OE 72-20-116



**12920**

0,02 4 100

9,80€



4 Nm (screw)

4 Nm (nut)



**12923**

0,01 4 100

9,80€



OE TPK43211

8 Nm



**12924**

0,01 4 100

5,70€



1.4 Nm (screw)

4.0 Nm (nut) OE 72-20-116



**12925**

0,02 4 100

9,80€



## KIT DE HERRAMIENTAS PARA MONTAJE Y DESMONTAJE DE VÁLVULAS TPMS

**52818** 1,38 10  
168,00€  

- Set de herramientas múltiples especialmente diseñadas para facilitar el montaje y desmontaje de los sensores TPMS.  
- Dispone de todas las herramientas que el operario necesita para efectuar el cambio de una forma rápida.

- ① 2-14 NM
- ② 0,5-3,5 NM
- ③ 2xØ 11, 12mm
- ④ 3x T10, T15, T20
- ⑤ 150mm
- ⑥ 2mm
- ⑦ 0,25 Nm
- ⑧ 0,45 Nm



## ÚTIL PARA OBUSES

**52653** 0,04 10 250 6.000  
3,00€   



- Para instalar y desinstalar obuses.





## LLAVE MULTIFUNCIONAL OBUSES

**52652** 0,03 25 100 7.200   
2,80€   



## SENSOR TPMS VÁLVULA DE GOMA



**53723** 0,04 4   EU-PRO HYBRID 3.5  
68,00€

- De fácil programación.  
- Útil para el 98% de la flota de vehículos en el mercado.

- Sistema de fijación de tuerca: rosca.  
- Par de apriete: 1,4Nm.



## SET DE TAPONES Y OBUSES PARA NEUMÁTICOS

**52673** 0,23 25 875  
18,00€   



### TAMBIÉN DISPONIBLE

**11900**   
3,50€  
Tapón de aluminio para válvula neumático en blister de 4 unidades

**11902**   
3,50€  
Tapón de plástico negro para válvula neumático en blister de 4 unidades

**11901**   
2,50€  
Tapón de plástico verde para válvula neumático en blister de 4 unidades

### CONTIENE

**11903** Bolsa 16 unidades tapón aluminio para válvula neumático  
5,00€

**11905** Bolsa 50 unidades tapón plástico negro para válvula neumático  
1,50€

**11907** Bolsa 50 unidades obuses alta presión  
11,00€

**11904** Bolsa 50 unidades tapón plástico verde para válvula neumático  
2,00€

**11906** Bolsa 50 unidades obuses estandar  
8,50€



**11960** Extracción obuses  
1,50€

## SET DE REPARACIÓN DE NEUMÁTICOS

**52662** 0,66 10 440  
36,50€   



- 1x Barrena de perforación
- 1x Barrena de inserción de mechas
- 1x Util para inflar neumáticos
- 4x Botellas de aire comprimido 16gr
- 1x Cuter
- 10x Mechas
- 1x Llave multifuncional obuses

**52663** 1,23 10 320  
33,00€   



- 1x Barrena de inserción de mechas
- 1x Punta para barrena de inserción de mechas
- 1x Barrena de perforación
- 1x Cuter
- 20x Mechas
- 1x Lubricante

### MECHAS DE RECAMBIO PARA REF. 52662/52663

**12973** 0,34 10 500  
1,00€   

x5



### BARRENA DE PERFORACIÓN PARA REF. 52663

**13806** 0,35 5 50  
10,50€   



### BARRENA DE INSERCIÓN DE MECHAS PARA REF. 52663

**13805** 0,5 50  
10,50€  





## VÁLVULAS PARA LLANTAS

TR413

**51741**

0,50€

0,01 100 1.000 48.000

45mm



x100

51mm

TR414

**51742**

0,50€

0,01 100 1.000 48.000



64mm



TR418

**51743**

0,55€

0,01 100 1.000 48.000

## ÚTIL INSTALACIÓN VÁLVULAS NEUMÁTICO

- Para montar válvulas en llantas de vehículos.

METAL

**52649**

5,00€

0,32  
10  
50  
2.250



PLÁSTICO

**52650**

5,00€

0,12  
10  
100  
2.400



## HERRAMIENTA REPARACIÓN MULTIUSOS

**52654**

6,50€

0,24 25 100 800



- Llave allen: 4 - 3 - 2,5 - 2mm.
- Llave 12 cantos: 9, 10, 12, 13, 15mm.
- Destornillador PH1.
- Destornillador plano SL1.
- Punta allen 5 - 6mm.
- Vaso de Ø6mm.



## RODILLO PARA REPARACIÓN DE NEUMÁTICOS

**52842**

11,00€

0,15 10 100 1.500

38mm



## SET DE 3 PROTECTORES DE LLANTAS

**53419**

9,00€

0,1 10 100 600

3 PCS



## LLAVE EN CRUZ UNIÓN SOLDADA

**51661**

11,50€

1,17 5 20 480

355mm

1/2"

17, 19, 21mm

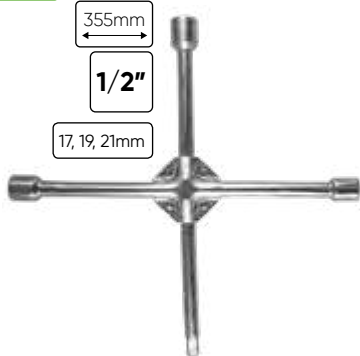

**52881**

17,00€

1,4 10 420

400mm

1/2"

17, 19, 21, 22mm

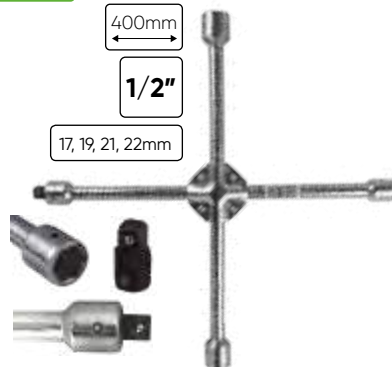

**52880**

38,50€

3,75 5 100

700mm

3/4"

24, 27, 32mm

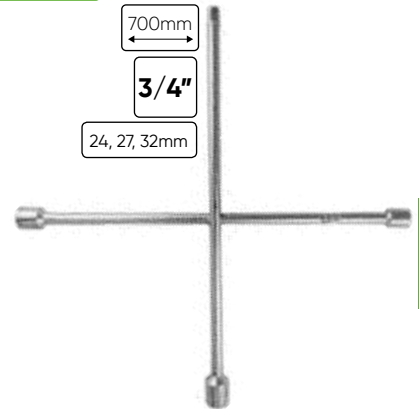

## LLAVE EXTENSIBLE DE RUEDA CON VASOS REVERSIBLES

**51416**

12,00€

1,09 10 20 600

330-490mm

1/2"



VASOS CROMADOS

21mm /23mm

17mm /19mm



# UÑA DE PLÁSTICO RECAMBIO PARA DESMONTADORA DE NEUMÁTICOS

**52657**

0,18 20 800

37,90€



**52658**

0,16 20 800

37,90€



**52659**

0,26 20

37,90€



## PALANCA PLÁSTICA PARA DESCALZAR NEUMÁTICOS

**52655**

37,00€

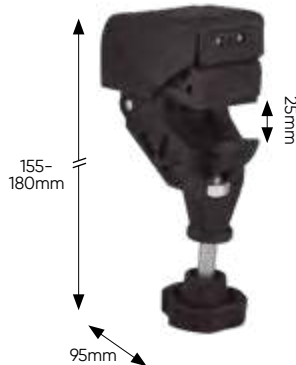

**52656**

29,50€



## PALANCA PARA EXTRAER NEUMÁTICOS

**51362**

3,00€



12"

304,8mm

**51358**

7,50€



16"

406,4mm

**51359**

9,00€



24"

609,6mm

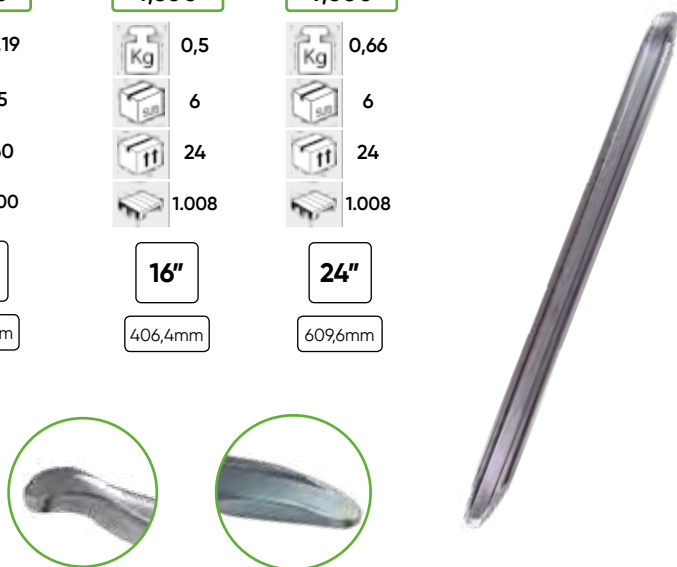

## DESMONTADORA DE NEUMÁTICOS MANUAL

**53605**

16 1 21

141,00€



950mm

- Incluye:  
1 Manija para interruptor de reborde 37 IN.  
Herramienta larga de montaje y desmontaje.

- Capacidad de los neumáticos:  
Todas las llantas desde 8" hasta las llantas de camiones ligeros (7- 1/2" x 16").

- Neumáticos de flotación:  
Hasta 12,5L 16.



## PALANCAS PARA CAMBIO DE RUEDAS INDUSTRIALES

**52664**

12,3 2 18

168,00€





## CARRO PORTA NEUMÁTICOS

**52660**  
128,00€

7,88  
 1  
 18



**52661**  
290,00€

19,4  
 1  
 10

ALTA CAPACIDAD



## CALZADORA DE NEUMÁTICOS PORTÁTIL

**52552**  
128,00€

12 1 14

-20°C  
40°C 6-8 BAR  
87-116 PSI MAX.  
10 BAR  
145 PSI



BOQUILLA DE RECAMBIO  
PARA REF. 52552

**13741**  
21,00€

0,7 32 15

## HERRAMIENTA PARA MONTAJE FUELLES DE PALIER

**52829**  
19,00€

0,43 10 20 200

EXTERIOR Ø 10cm  
INTERIOR Ø 9,5cm



## HERRAMIENTA NEUMÁTICA PARA MONTAJE DE FUELLES DE PALIER

**51861**  
199,00€

4,08 1 2 32

- Material: Aluminio.  
- Apertura de 20 a 100mm.

9 bar  
(125 PSI)



## SERIE PROMOCIONAL ESPECIAL FUELLES

**SERIE124**  
559,00€

20,94 20

BOLSA GRASA FUELLE  
TRANSMISION

**13879**  
1,20€

0,09 150 4.800



**51861** x1



**52633** x100



**13738** x100



**13879** x100

## CAJA DE 100 KITS DE FUELLE

**53693**  
520,00€

19,80 1



x100  
**13738**

x100  
**52633**

x100  
**13879**

## CAJA DE 100 KITS DE FUELLE DE PALIER PARA FURGONETA

**53698**  
550,00€

19,80 1



x100  
**13739**

x100  
**52633**

x100  
**13880**

## CAJA DE 80 KITS DE FUELLE DE DIRECCIÓN

**53695**  
576,00€

11,25 1



x80  
**13740**

x80  
**52633**

x80  
**13880**

## KIT DE FUELLE DE PALIER UNIVERSAL NEOPRENO

PARA TURISMO

**51705**

0,23 1 20 320

7,00€



PARA FURGONETA

**51703**

0,28 20 280

8,50€



RECAMBIO PARA  
REF. 51703

**13739**

0,08 150

5,00€



RECAMBIO PARA  
REF. 51705

**13738**

0,08 150

3,00€



## KIT FUELLE DIRECCIÓN UNIVERSAL

**52644**

0,19 20 240

7,50€



NEOPRENO



BOLSA GRASA FUELLE  
DIRECCIÓN

**13880**

1,20€



RECAMBIO PARA  
REF. 52644

**13740**

5,00€

0,01 100



## ABRAZADERAS

**11891**

0,01

0,50€



100

5.000

x100

15-45mm



**11890**

0,02

0,55€



100

1.000

x100

50-125mm



## PACK DE 2 ABRAZADERAS

**52633**

0,02 100 800 16.000

1,00€



UTILIZAR CON ALICATES  
REF. 52619

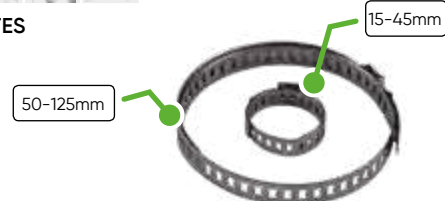

## CASQUILLO CENTRADOR

REF.					€
52645	0,02	50	1.000	38.000	0,55€
52646	0,01	50	1.000	80.000	0,50€
53037	0,01	50	1.000	-	0,50€
53038	0,01	50	1.000	-	0,50€
53039	0,02	50	1.000	-	0,50€
53040	0,01	50	1.000	-	0,50€

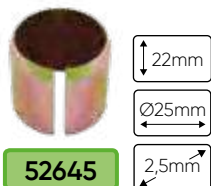

x50

## TUBOS FLEXIBLES INNERBRAID



DISPONIBLE  
EN CAJA  
INDIVIDUAL

REF.	DESCRIPCIÓN				€
51706	Ø 25mmL x 300mmL	0,27	25	1.500	19,50€
51707	Ø 45mmL x 100mmL	0,27	25	1.200	9,00€
51708	Ø 45mmL x 150mmL	0,41	25	900	13,00€
51709	Ø 45mmL x 200mmL	0,49	25	750	14,00€
51710	Ø 45mmL x 250mmL	0,65	25	600	16,50€
51711	Ø 45mmL x 300mmL	0,81	25	450	19,50€
51712	Ø 50mmL x 100mmL	0,26	25	700	9,60€
51713	Ø 50mmL x 150mmL	0,46	25	700	12,00€
51714	Ø 50mmL x 200mmL	0,59	25	600	15,80€
51715	Ø 50mmL x 250mmL	0,73	25	600	19,00€
51716	Ø 50mmL x 300mmL	0,83	25	450	22,30€
51717	Ø 55mmL x 100mmL	0,35	25	700	11,20€
51718	Ø 55mmL x 150mmL	0,47	25	450	13,60€
51719	Ø 55mmL x 200mmL	0,63	25	350	20,50€
51720	Ø 55mmL x 250mmL	0,82	25	350	22,00€
51721	Ø 55mmL x 300mmL	0,88	25	375	23,30€
51722	Ø 60mmL x 100mmL	0,37	25	700	13,05€
51723	Ø 60mmL x 150mmL	0,5	25	500	17,00€
51724	Ø 60mmL x 200mmL	0,64	25	400	22,50€
51725	Ø 60mmL x 250mmL	0,79	25	300	25,60€
51726	Ø 60mmL x 300mmL	0,96	25	250	33,00€
51727	Ø 60mmL x 400mmL	1,62	25	200	44,00€



EPIS



308

CÁMARAS TÉRMICAS / TERMÓMETROS



310

DISPENSADORES



312

DETERGENTE DE SUPERFÍCIES



313

LIMPIADORES / FÓRMULAS  
HIDROALCOHÓLICAS



313

DISTANCIA DE SEGURIDAD



314

 Por favor, mantengan la distancia de seguridad 

DESINFECCIÓN DE ESPACIOS



315

MEDIDOR DE OZONO



316



# SEGURIDAD Y EPIS



## GAFAS DE PROTECCIÓN SPORT - ANTIVAHO

0,01 12 144 2.016



**CUMPLE CON:**  
EN166:2002-04 / EN166:2003-01



53597 53596, 53597, 53598



53596

3,50€

53598

4,00€

53597

3,50€



**ANTIVAHO**



EN EXPOSITOR DE 12 UNIDADES

## GAFAS DE PROTECCIÓN SOLAR

52445

3,85€

0,06 12 300 1.800



PC



**CUMPLE CON:** EN166:2001

## GAFAS DE PROTECCIÓN ANTIVAHO

53785

4,80€

0,05 14 112 896



**CUMPLE CON:** Conforme a EN166:2002-04

- Protección directa frente a líquidos y bacteria.
- Cinta elástica ajustable.
- Tratamiento antivaho en lente.



**ANTIVAHO**



Válvulas incorporadas para evitar el vacío en el interior

## AURICULAR PASIVO PARA PROTECCIÓN AUDITIVA

52430

12,50€

0,34 6 24 240



PVC



ABS

**CUMPLE CON:** EN352 - 1:2003

## GUANTES DE HILO DE ALGODÓN CON LA PALMA REFORZADA DE PUNTITOS

51785

0,75€

0,04

UDS PACK 12

300

4.200

CE

PALMA REFORZADA

CE

CE

CE

CE

CE

CE

CE

CE

CE

CE

CE

CE

CE

CE

CE

CE

CE

CE

CE

CE

CE

CE

CE

CE

CE

CE

CE

CE

CE

CE

CE

CE

CE

CE

CE

CE

CE

CE

CE

CE



## GUANTES DE ALGODÓN

51745

0,70€

0,05

UDS PACK 12

144

3.744

CE

CE

CE

CE

CE

CE

CE

CE

CE

CE

CE

CE

CE

CE

CE

CE

CE

CE

CE

CE

CE

CE

CE

CE

CE

CE

CE

CE

CE

CE

CE



## GUANTES DESECHABLES DE NITRILO

REF. DESCRIPCIÓN UDS €

3.5 MIL

53984 M 0,50 100 10 400 Consultar

53985 L 0,50 100 10 400 Consultar

53986 XL 0,55 100 10 400 Consultar

**NUEVOS**



REF. DESCRIPCIÓN UDS €

4.0 MIL

53989 M 0,70 100 10 500 Consultar

53990 L 0,70 100 10 500 Consultar

53991 XL 0,70 100 10 500 Consultar

**NUEVOS**

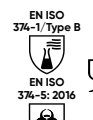

REF. DESCRIPCIÓN UDS €

5.5 MIL

53994 M 0,50 50 20 560 Consultar

53995 L 0,50 50 20 560 Consultar

53996 XL 0,55 50 20 560 Consultar

**NUEVOS**





## GUANTES CON PALMA REFORZADA DE POLIURETANO

<b>REF.</b>	0,03	12	144	3.456
2,00€				



51640N	T. 8
51642N	T. 9
51636N	T. 10
51638N	T. 11



## GUANTES CON PALMA REFORZADA DE NITRIL

<b>REF.</b>	0,04	12	144	3.456
2,00€				



51633	T. 8
51634	T. 9
51632N	T. 10
51398N	T. 11



## GUANTES DE PIEL Y TELA

<b>52310</b>	0,19	12	120	1.200
4,00€				



## GUANTES DE PIEL

<b>52738</b>	0,1	12	144	2.880	T. 9
5,00€					



<b>52739</b>	0,1	12	144	2.880	T. 10
5,00€					



## GUANTE ANTI-CORTE PANTALLA TÁCTIL

<b>52570</b>	T. 8							
4,00€								
0,03	12	144	3.456					

<b>52571</b>	T. 9							
4,00€								
0,03	12	144	2.592					

### PARA PANTALLA TÁCTIL



<b>52572</b>	T. 10							
4,00€								
0,03	12	144	2.592					

<b>52573</b>	T. 11							
4,00€								
0,04	12	144	2.592					

## CHALECO REFLECTANTE HOMOLOGADO

<b>53788ES</b>	0,12	100	2.600
3,95€			

DISPONIBLE EN CUALQUIER IDIOMA

Incluye mensaje de advertencia de mantener la distancia de seguridad de 2m entre personas.



<b>51817</b>	0,13	100	2.600
4,50€			

Banda marcada

<b>50966</b>	0,13	100	2.600
4,00€			

<b>50654</b>	0,13	100	2.600
4,00€			



CUMPLE CON: EN ISO20471:2013

## PROTECTORES DE METACRILATO

**53835** 2,30 8 108

38,00€

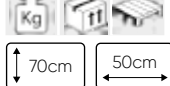

Grosor: 5mm  
Agujero:  
300x160mm  
Base: 150x200mm



**53836** 4,05 5 60

58,00€

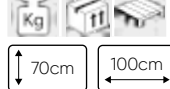

**53899** 2,30 8 108

12,00€



## MÁSCARA DE PROTECCIÓN ANTIVAHIO

**53798** 0,04 25 200 1.800

1,95€



Conforme a EN166

Protección directa frente a líquidos y bacteria.

- Espuma en la parte interior para mejorar la comodidad.
- Tratamiento antivaho en pantalla.
- Ajustable.



## TERMÓMETRO INFRARROJO

**53794** 0,15 80 1.200

36,20€



CON ALARMA DE SONIDO



PANTALLA DE FÁCIL VISUALIZACIÓN

distancia de medición:  
15 - 50mm



CON MEMORIA DE HASTA 32 REGISTROS

CE 0123

- Mide la temperatura corporal en **1 segundo** y **sin contacto**.
- Apagado automático después de 1 minuto.

**Rango de medición** 32,0°C - 42,2°C (89,6°F - 108°F)

**Precisión** ±0,2°C (35°C - 42°C)

2 pilas AAA INCLUIDAS



## CÁMARA CON SISTEMA DE MEDICIÓN DE TEMPERATURA

**53830** 3,15 1

2.996,00€



**Potencia:**

12VDC

**Internet:**

RJ45

**Relay :**

+ :NO - :COM



Audio  
Relé  
Toma de potencia  
Conexión de red

Funciona mediante conexión IP

## CÁMARA DE VISIÓN TÉRMICA

**53795** 0,80 5

1.450,00€



**Rango de temperatura:**

30° - 45° C

**Precisión:**

± 0,5°C

**Distancia de medición óptima:**

1 metro

**Resolución:**

0,1°C

**Resolución térmica:**

160x120

Luz LED

imagen térmica infrarroja

gatillo para captura imágenes



CON SISTEMA DE ALARMA

cumple con:  
EN61326-1-2013,  
EN61326-2-2:2013,  
EN61326-2-3 ROHS

¿quieres ver cómo funciona?

VIDEOTUTORIAL DISPONIBLE EN

YouTube



**14786** TRÍPODE PARA (REF. 53795)

48,00€

1,10 10



Ideal para medir y controlar la temperatura en las entradas de escuelas, edificio, tiendas, estaciones, etc.



Dispone de sensor térmico y algoritmo de captura de rostros



Puede capturar el rostro humano y medir la temperatura al mismo tiempo



Software de monitorización incluido

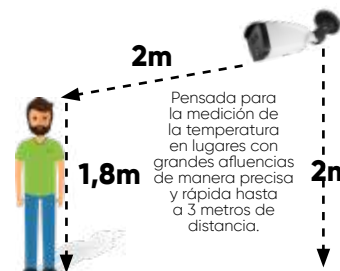

Pensada para la medición de la temperatura en lugares con grandes afluencias de manera precisa y rápida hasta a 3 metros de distancia.

VIDEOTUTORIAL DISPONIBLE EN

YouTube





# MASCARILLAS DE PROTECCIÓN AUTOFILTRANTE

## FFP2

- Un material de filtración de varias capas: polipropileno.
- Forro interno que mejora la estanqueidad y la comodidad de uso.

- Arco de aluminio para fácil adaptación a la nariz.
- Goma elástica de fácil sujeción.
- Diseño en arco para una respiración más suave.

**53787**

0,01 10 800 9600



0,58€

**ANTIVAHO**

CON VÁLVULA

**53844**

0,02 3 360 1.440



2,80€

Servidos en cajas de 3 unidades



- Almohadilla de puente nasal antivaho
- 2 Bandas de goma elástica que se ajustan por detrás de la cabeza

Penetración del material filtrante	≤ 6%
Fuga total	≤ 11%
Resistencia respiratoria máx.	30l/min (inhalación): ≤ 0.70 mbar 95l/min (inhalación): ≤ 2.4 mbar 160l/min (exhalación): ≤ 3 mbar



- Material filtrante de varias capas.
- Sello nasal de espuma de poliuretano.
- Forro interno que mejora la estanqueidad y la comodidad.



**95% EFB: EFICACIA A LA FILTRACIÓN BACTERIANA**



Presentación en bolsas de 10 unidades.



Homologada según reglamento UE 2016/425  
Cumple con la normativa EN149:2001



Homologada según reglamento UE 2016/425  
Cumple con normativa EN149:2001+A1:2009

**53946**

0,78€

**537870**

0,78€

**53959**

0,78€

**53960**

0,78€

**53961**

0,78€

**53963**

0,78€

0,01 10 1000 9000



Presentación en bolsas de 10 unidades.

Penetración del material filtrante	≤ 6%
Fuga total	≤ 11%
Resistencia respiratoria máx.	30l/min (inhalación): ≤ 0.70 mbar 95l/min (inhalación): ≤ 2.4 mbar 160l/min (exhalación): ≤ 3 mbar



Homologada según reglamento UE 2016/425  
Cumple con normativa EN149:2001+A1:2009

## FFP3

**53916**

3,80€

0,03 10 200 1.600



- Material de filtración de 3 capas: polipropileno.
- Una pinza nasal para dar forma a la media máscara de la nariz.
- Válvula de exhalación
- Las bandas para la cabeza hechas de hilo de goma trenzado sin látex.
- Cierres de plástico de las bandas de la cabeza.
- Forro interno que mejora la estanqueidad y la comodidad.



Homologada según reglamento UE 2016/425  
Cumple con normativa EN149:2001

Penetración en el material filtrante por aerosol de cloruro de sodio o neblina de aceite	≤ 1%
Tiempo máximo de uso	8 horas

CON VÁLVULA INCORPORADA

## DE UN SOLO USO

### QUIRÚRGICA IIR

**53907**

0,16€

0,01 50 2.000 24.000



EFB eficacia a la filtración bacteriana	≥ 98%
Limpieza microbiana	≤ 30 CFU/g



USO MÉDICO



EN 14683: 2019+AC:2019  
EN ISO 13485:2016  
EN ISO 11737-1:2018  
ISO 22609:2004

### HIGIÉNICA

**53797**

0,10€

0,01 50 2.000 24.000



EFB eficacia a la filtración bacteriana	>90%
Resistencia a la respiración	35-50 Pa

USO NO MÉDICO.

UNE 0064-1:2020



En bolsas de 10 unidades.  
Entregadas en cajas de 50 unidades.

## ALFOMBRAS PARA LA LIMPIEZA DE LOS ZAPATOS

### ALFOMBRA DESINFECTANTE

CON DEPÓSITO PARA LÍQUIDO

**53862**

51,00€

1,45 5 100



- Medidas: 85x55x10cm
- Material: TPE
- Capacidad máxima recomendada: 3L
- Capacidad máxima: 8L



## DISPENSADOR DE FUNDAS DE CALZADO

**53781**

28,00€

2,20 8 32



- Permite cubrir los pies con fundas de plástico únicamente colocándolos en el interior del dispensador.
- Incluye 8 piezas de PVC en la base para una mayor sujeción y un juego de 100 fundas.

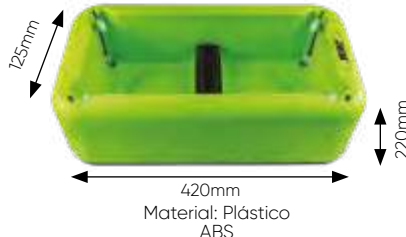

100 FUNDAS DE CALZADO

**14781**

9,90€

0,25 84 336



### MOQUETA PARA SECADO

**53863**

15,50€

0,70 5 240



- Medidas: 76x48cm
- Material: Poliéster

GARRAFA 5L LIQUIDO DETERGENTE P/ALFOMBRA 53862

**53893**

21,00€

4,50 4 128



## DISPENSADOR AUTOMÁTICO 1200ml

**53902**

49,00€

1,15 18 144



- Dosificación: ajustable de 0,7ml a 1,4ml.
- Compatibles con jabón líquido, alcohol, gel y desinfectante de manos.
- Voltaje: 6V 1.5A
- Medidas: 160x120x295mm.
- Material: ABS.



DISTANCIA DE ACTIVACIÓN DEL SENSOR: 8-12CM

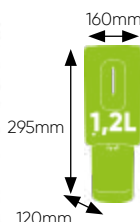

Incluye soporte y tornillos para fijar en pared.

ADAPTADOR AC/DC 6V 1.5A

**15059**

10,00€

0,10 200



PILA R14 C1.5V

**15062**

1,00€

0,01 24 480



## DISPENSADOR AUTOMÁTICO 400ML

**53826**

26,00€

0,35 40 400



- Compatible con jabón líquido, alcohol, gel y desinfectante de manos.
- Sensor infrarrojo de movimiento con luz led.
- Dosificación: 1ml.
- Voltaje : 6V (4 pilas de 1,5V).
- Pilas no incluidas.



DISTANCIA DE ACTIVACIÓN DEL SENSOR: 5CM



BASE IMPERMEABLE: CON UN ANILLO DE SILICONA FLEXIBLE EN LA TAPA INTERIOR

## PIE PARA DISPENSADOR DE GEL AUTOMÁTICO

**53827**

67,00€

4,80 1 42



- Peso: 4.3kg
- Material: Acero
- Color: Negro
- Medidas de la bandeja: 417x67mm
- Medidas del soporte para el dispensador: 480x133mm
- Diámetro de la base: 395mm



## DOSIFICADOR PARA GARRAFA

**14793**

18,60€

0,05 100 1.200

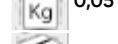

## BOLSAS DE PVC CON CREMALLERA

**14918**

0,20€

0,01 100 2.400 38.400



25 x 30cm



**14919**

0,50€

0,01 1.500



60 x 18 cm





# DETERGENTE LIMPIADOR DE SUPERFICIES DURAS

## FORMATO LÍQUIDO



**53829** 4,45 4 128  
24,00€

**53828** 0,90 12 324  
7,30€

## FORMATO SPRAY

Limpia todo tipo de superficies:  
hogar - coche - oficina - AACC

- Spray ideal para limpiar todo tipo de superficies.
- Aspecto físico: Líquido transparente.
- Contiene: Isopropanol / Etanol.



**53824** 0,40 24 1.152  
9,00€



**53804**  
1,80€

válidos para  
AACC

0,10 35 2.940  
Kg tfl

## PISTOLA PLÁSTICA PARA BOTE DE SPRAY

Útil accesorio para utilizar con la mayoría de sprays del mercado.



**52493** 0,06 10 150 600  
4,50€

# CUIDADO E HIGIENE DE MANOS: LIMPIADORES Y FÓRMULAS HIDROALCOHÓLICAS

## FORMATO GEL

- Higiene y limpieza profunda.
- Máxima efectividad.



- Contiene: propan-2-ol, alcohol isopropílico / propan-1-ol, n-propanol

**Modo empleo:**  
Aplicar sobre la piel sana y seca una cantidad suficiente de producto y frotar durante al menos 30 segundos. No necesita aclarado.



**53832** 0,65 24 48 3.360  
1,90€



**53791** 0,47 6 576  
5,80€



**53790** 4,30 4 128  
19,80€

## FORMATO LOCIÓN

### válidos para superficies

- Solución hidroalcohólica con glicerina y aloe vera para la higiene y el cuidado de las manos.



**53822** 0,45 19 760  
4,80€



## FORMATO ESPUMA

**53803**  
1,80€



0,15  
35  
3.780  
Kg tfl

Producto cosmético ideal para limpiar y sanear las manos.

Gracias a su formulación limpia las manos rápidamente y da una sensación inmediata de bienestar y suavidad en la piel.

El producto aplicado no requiere enjuague, no engrasa, no se pega y garantiza una profunda higiene para uno mismo y para los demás.



## POSTE DE SEPARACIÓN CON CINTA RETRÁCTIL

53914

75,60€

8,5



5



- Material: Acero
- Diámetro del tubo: 63mm
- Diámetro de la base: 320mm
- Altura: 910mm

- Salida de cinta en 4 direcciones
- Largo de la cinta: 3m
- Ancho de cinta: 48mm

910mm



SALIDA DE CINTA EN 4 DIRECCIONES

## CINTAS DE BALIZAMIENTO 200M

53811

15,90€

0,45



53987

8,30€

0,59



200M X 10cm

200M X 10cm

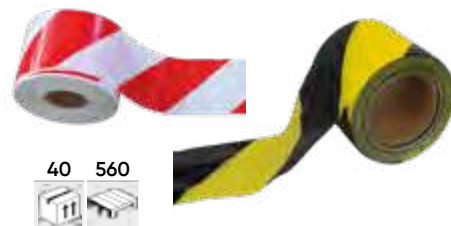

## POSTE DE PLÁSTICO PARA CADENA ESPECIAL ALTA TENSION

53940

13,20€

0,55



6



96



- De PVC.
- Franjas amarillas y negras.

CADENA NO INCLUIDA

- ✓ Para un vallado sencillo, rápido y móvil de zonas interiores y exteriores con limitaciones.

- ✓ Sus colores contrastantes hacen la cadena altamente visible para restringir áreas de alta tensión.



ESPECIAL SEÑALIZACIÓN ALTA TENSION

850mm



BASE RELLENABLE DE AGUA O ARENA PARA UNA MEJOR FIJACIÓN



## ESLABÓN DE ENCAJE NEGRO

53942

0,50€

0,01



50



5.000



75.000



## CADENA DE PLÁSTICO

53941

5,75€

0,30



40



600



- Longitud: 5m
- Eslabón: 6mm
- Color: Amarillo / Negro

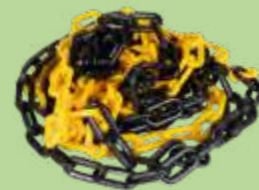

## POSTE DE PLÁSTICO PARA CADENA

53808

16,50€

0,55



6



120



- De PVC.
- Franjas blancas y rojas de 130mm de largo.

CADENA NO INCLUIDA

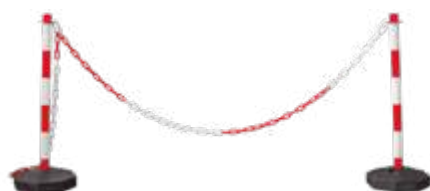

BASE RELLENABLE DE AGUA O ARENA PARA UNA MEJOR FIJACIÓN

850mm



## ESLABÓN DE ENCAJE

53839

0,25€

0,01



10



2.000



## CADENA DE PLÁSTICO

53809

8,00€

1,30



40



560



- Longitud: 5m
- Eslabón: 6mm
- Color: Rojo / Blanco



## CINTA ADHESIVA DE SEÑALIZACIÓN DISTANCIA DE SEGURIDAD

53840ES

9,80€

0,05



10



360



1.000x1.000 mm

DISPONIBLE EN CUALQUIER IDIOMA

- Texto: "¡POR FAVOR! MANTENGA LA DISTANCIA DE SEGURIDAD"

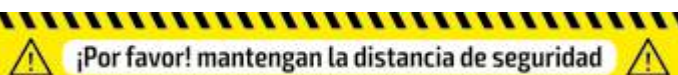

## ADHESIVO REDONDO DISTANCIA DE SEGURIDAD

53843ES

8,35€

0,05



60



Ø 400mm

DISPONIBLE EN CUALQUIER IDIOMA

- Texto: "¡POR FAVOR, MANTENGA LA DISTANCIA DE SEGURIDAD. ESPERE AQUÍ"

Antideslizante





# GENERADORES DE OZONO PORTÁTILES

Desinfecta el aire en habitaciones usando ozono o<sub>3</sub> para oxidar prácticamente cualquier partícula: virus, bacterias, componentes orgánicos e inorgánicos. Utilizarse en áreas desocupadas



AMPLIAS APLICACIONES



HOGAR



OFICINA



FURGONETAS



CAMIONES

5.000mg/h

**53786**

128,00€



Tiempo de operación recomendado según tamaño de la habitación:

50m <sup>3</sup>	100m <sup>3</sup>	150m <sup>3</sup>	200m <sup>3</sup>	300m <sup>3</sup>
20min	40min	60min	80min	100min

PLACA PARA REF. 53786

**14775**

30,50€

600mg/h

**53796**

99,15€



IDEAL PARA VEHÍCULOS

LIGERO, RÁPIDO Y POTENTE

BAJO NIVEL DE RUIDO

TAMAÑO PORTÁTIL



Conexión a electricidad y conexión a toma de mechero.

10.000mg/h

**53805**

220,00€



- Ligero, rápido y potente.
- Bajo nivel de ruido.
- 3 tipos de desinfección: ozono, ion, ozono + ion.
- Temporizador y modelo de retención.
- Tamaño portátil con asa.



Volumen habitación	Tiempo de trabajo requerido
50m <sup>3</sup>	8 min
100m <sup>3</sup>	16 min
150m <sup>3</sup>	24 min
200m <sup>3</sup>	32 min
300m <sup>3</sup>	48 min

PLACA PARA REF. 53805

**14802**

44,00€

# GENERADORES DE OZONO PORTÁTILES

10.000mg/h - 20.000mg/h

**53806**

290,00€

3,90 4 32

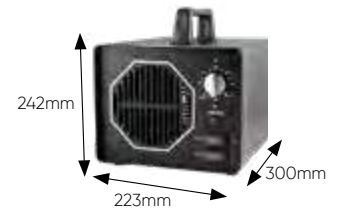

- Ligero, rápido y potente.
- Bajo nivel de ruido.
- Filtro de aire y placa de ozono fácilmente reemplazables.
- Tamaño portátil con asa.
- Disipador de calor para evitar un sobrecalentamiento en la placa de ozono.



PLACA PARA REF. 53806

**14803**

42,50€



**INCORPORA LUZ UV PARA ESTERILIZAR**

## 2 MODOS DE TRABAJO

LOW 10.000mg/h		HIGH 20.000mg/h	
Volumen habitación	Tiempo de trabajo requerido	Volumen habitación	Tiempo de trabajo requerido
50m <sup>3</sup>	8 min	500m <sup>3</sup>	30 min
100m <sup>3</sup>	16 min	600m <sup>3</sup>	40 min
150m <sup>3</sup>	24 min	700m <sup>3</sup>	50 min
200m <sup>3</sup>	32 min	800m <sup>3</sup>	60 min
300m <sup>3</sup>	48 min	900m <sup>3</sup>	70 min
500m <sup>3</sup>	65 min	1.000m <sup>3</sup>	80 min

# CAJA DE TRATAMIENTO DE OZONO

**53838**

48,00€

1,10 8 96

- ✓ HIGIENIZA
- ✓ POTENTE

- ✓ SEGURO Y EFICAZ
- ✓ ELIMINA MALOS OLORES

- ✓ RÁPIDO
- ✓ TRANSPORTABLE



TIEMPO DE DESINFECCIÓN



BOLSILLO POSTERIOR



DESMTABLE

La caja se monta y desmonta fácilmente, facilitando así su transporte.

- Longitud de onda ultravioleta: 254nm
- Toma de potencia: Conector micro-USB

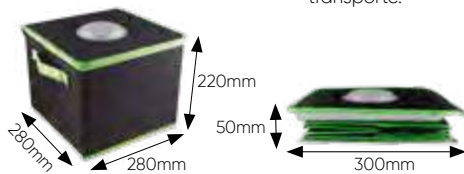
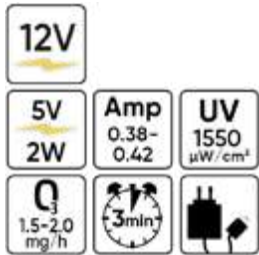

# MEDIDOR DE OZONO

**53802**

290,00€

0,65 20 240



- Precisión: ≤±5% F.S.
- Rango de medida: 0-50ppm (0-98mg/m<sup>3</sup>)
- Alarma baja: 5ppm (98mg/m<sup>3</sup>)
- Alarma alta: 10ppm (196 mg/m<sup>3</sup>)
- Tiempo de respuesta: <30 segundos
- Temperatura de trabajo: -10°C - 55°C
- Protección IP65.

**DOS NIVELES DE ALARMA CONFIGURABLES PARA DIFERENTES NIVELES DE CONCENTRACIÓN**



TIEMPO DE TRABAJO: >8H

TIEMPO DE CARGA: 4H-6H



109x60x30mm



cumple con: EN61326-1, EN61000-4-2, EN61000-4-3



PASACABLES / PASADORES



318

CHAVETAS / TORNILLOS Y TUERCAS

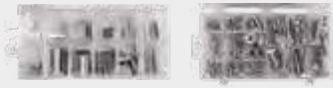

319

REMACHES



321

ARANDELAS



322

JUNTAS TÓRICAS / OBUSES



326

TUBOS TERMORETRÁCTILES / CONECTORES DE MANGUERA / ENGRASADORES



326

ABRAZADERAS / MUELLES / FUSIBLES



328

TERMINALES



329

CLIPS PLÁSTICOS



330



# CONSUMIBLES



**SERIE346**

## ESTUCHE DE CIRCLIPS TIPO "E"

53348

0,3 6 24

14,00€

Kg



150  
PCS



M1.5	M3	M5	M6	M9	M12	M15	M19	M22
15 PCS	15 PCS	20 PCS	25 PCS	25 PCS	20 PCS	10 PCS	10 PCS	10 PCS

## ESTUCHE DE PASACABLES DE GOMA

53349

0,25 6 24

14,00€

Kg



125  
PCS



19,5x23 2 PCS	16x24 3 PCS	13x15 3 PCS	11,5x19 4 PCS	10x20 3 PCS	10x12 5 PCS	25 2 PCS	22 3 PCS	19 4 PCS	15 5 PCS
9,8x11,5 6 PCS	8x14 3 PCS	7,5x13 7 PCS	6x7,5 10 PCS	3,5x6 15 PCS	12 10 PCS	9 20 PCS	7 20 PCS		

## ESTUCHE DE PASACABLES DE GOMA

53370

0,3 6 12

26,00€

Kg



190  
PCS



M2	M3	M4	M5	M6	M8	M10
25 PCS	25 PCS	30 PCS	30 PCS	30 PCS	20 PCS	20 PCS

## ESTUCHE DE PASADORES ELÁSTICOS

53350

0,4 6 24

14,00€

Kg



120  
PCS



1/16x3/16 4u.	3/32x1-1/4 4u.	3/16x1 5u.	1/4x1-3/4 4u.
1/16x5/16 4u.	1/8x5/8 5u.	3/16x1-1/4 5u.	5/16x3/4 4u.
1/16x3/4 4u.	1/8x1 5u.	7/32x5/8 4u.	5/16x1-1/2 4u.
5/64x1/4 4u.	1/8x1-1/4 5u.	7/32x1-1/4 4u.	5/16x2 4u.
5/64x1/2 4u.	5/32x5/8 4u.	7/32x1-3/4 4u.	3/8x3/4 2u.
5/64x1 4u.	5/32x1 4u.	1/4x5/8 4u.	3/8x1-1/2 2u.
3/32x5/8 4u.	5/32x1-1/2 4u.	1/4x1-1/4 4u.	3/8x2 2u.
3/32x1 4u.	3/16x5/8 5u.		

## ESTUCHE PASADORES

52027

1,02 6 12 690

14,00€

Kg

365  
PCS



1,2x25mm 50 PCS	1,6x32mm 50 PCS	2x40mm 50 PCS	2,5x40mm 50 PCS	3,2x40mm 50 PCS
3,2x50mm 50 PCS	4x50mm 40 PCS	5x63mm 10 PCS	6,3x63mm 15 PCS	

## ESTUCHE PASADORES

53372

1,2 6 12

26,00€

Kg



144  
PCS



3x50mm 50 PCS	4x60mm 30 PCS	5x75mm 20 PCS	6x50mm 20 PCS	6x75mm 16 PCS	8x60mm 8 PCS
------------------	------------------	------------------	------------------	------------------	-----------------



## ESTUCHE DE PASADORES CON ANILLA

53371

1,45 6 12

26,00€



50  
PCS



	5x36	6x45	8x45	11x45
	16 PCS	18 PCS	6 PCS	10 PCS

## ESTUCHE DE PASADORES CLEVIS Y CLIPS EN "R"

53363

1,15 6 24

28,00€



71  
PCS



	8x50	9,5x50	11x63	12,5x50
	5 PCS	18 PCS	5 PCS	3 PCS

	3,5x44	2,5x42	2,5x58	2x3
	6 PCS	20 PCS	7 PCS	7 PCS

## ESTUCHE CLIPS "R"

52044

19,00€



150  
PCS

## ESTUCHE DE CHAVETAS

53364

0,8 6 24

14,00€



106  
PCS



	3x3x25	3x3x20	5x5x30	5x5x25	5x5x20	6x6x40	6x6x30
	4 PCS	4 PCS	5 PCS	5 PCS	5 PCS	5 PCS	5 PCS
			6x6x20	8x8x40	8x8x30	10x10x40	10x10x30
			5 PCS	5 PCS	5 PCS	5 PCS	2 PCS

**X** DESPIECE DISPONIBLE EN BOLSAS



REF.	MEDIDA	UDS.	€/u.
10882	2,00x32mm	45	0,25€
10883	1,60x36mm	30	0,25€
10884	1,60x42mm	25	0,25€
10793	2,30x43mm	25	0,25€
10794	3,20x52mm	20	0,40€
10795	3,80x75mm	8	0,60€

## ESTUCHE DE TORNILLOS DE GANCHO

53352

0,6 6 24

12,00€



151  
PCS



	2,4x25	4x45	4x50
	60 PCS	12 PCS	12 PCS

	2,4x41	4x64	4,2x85
	50 PCS	12 PCS	5 PCS

## ESTUCHE DE TORNILLOS Y TUERCAS

53351

0,9 6 12

12,50€



240  
PCS



	4x12	4x20	5x16	5x25
	10 PCS	10 PCS	10 PCS	10 PCS
	6x20	6x30	8x25	8x40
	10 PCS	10 PCS	5 PCS	5 PCS
	10x16	10x40		
	5 PCS	5 PCS		

	4	5	6	8	10
	20 PCS	20 PCS	20 PCS	10 PCS	10 PCS

	4	5	6	8	10
	20 PCS	20 PCS	20 PCS	10 PCS	10 PCS

## ESTUCHE DE TORNILLOS AUTOROSCANTES

53354

0,55 6 24

12,50€



200 PCS



#8x12.5 #8x16 #8x19 #8x25 #10x12.5 #10x16 #10x19 #10x25

30 PCS

30 PCS

30 PCS

30 PCS

20 PCS

20 PCS

20 PCS

20 PCS

## ESTUCHE DE TORNILLOS ALLEN

53362

0,65 6 24

12,00€



106 PCS



4x12

5x12

5x25

10x40

6x25

8x40

10x25

6x12

8x25

25 PCS

25 PCS

20 PCS

3 PCS

10 PCS

5 PCS

3 PCS

10 PCS

5 PCS

## ESTUCHE DE TORNILLOS Y TUERCAS TIPO U

53366

0,35 6 24

12,50€



170 PCS



#6x5/16

40 PCS

#8x5/8

20 PCS

#6

20 PCS

#6

20 PCS

#8

20 PCS

#10x1/2

15 PCS

1/4x3/4

10 PCS

1/4

10 PCS

#10

15 PCS

## ESTUCHE DE TORNILLOS

53369

0,65 6 24

13,00€



550 PCS



4x1/2"

65 PCS

4x5/8"

55 PCS

6x3/8"

60 PCS

6x1/2"

65 PCS

6x5/8"

60 PCS

6x3/4"

45 PCS

8x1/2"

50 PCS

8x5/8"

40 PCS

8x1"

30 PCS

8x1-1/4"

20 PCS

10x3/4"

25 PCS

10x1"

20 PCS

10x1-1/4"

15 PCS

## ESTUCHE TUERCAS AUTOBLOCANTES

52029

1,02 6 12 360

14,00€



228 PCS



M3

50 PCS

M4

50 PCS

M5

40 PCS

M6

30 PCS

M8

20 PCS

M10

15 PCS

M12

10 PCS

M14

8 PCS

M16

5 PCS

## ESTUCHE DE TUERCAS

52028

1,05 5 360

11,50€



243 PCS



DESPIECE DISPONIBLE EN BOLSAS

REF.	MEDIDA	UDS.	€/u.
10805	M3	50	0,10€
10779	M4	50	0,05€
10780	M5	50	0,05€
10781	M6	30	0,05€
10784	M7	20	0,05€
10785	M10	20	0,10€
10786	M12	10	0,15€

REF.	MEDIDA	UDS.	€/u.
10812	M14	8	0,30€
10813	M16	5	0,30€





## ESTUCHE DE TUERCAS MARIPOSA

53365

0,75 6 24

14,00€



150  
PCS



	M4 40 PCS	M5 40 PCS	M6 25 PCS	M8 25 PCS	M10 20 PCS
--	-----------------	-----------------	-----------------	-----------------	------------------

## ESTUCHE DE REMACHES TUERCA DE ALUMINIO

53361

0,2 6 24

20,00€



150  
PCS



3x9 40 PCS	4x11 35 PCS	5x13 25 PCS	6x15 25 PCS	8x18 15 PCS	10x21 10 PCS
------------------	-------------------	-------------------	-------------------	-------------------	--------------------

## ESTUCHE REMACHES TUERCA

52703

0,79 6 24 800

19,00€



235  
PCS



M3 50 PCS	M4 50 PCS	M5 50 PCS	M6 40 PCS	M8 20 PCS	M10 15 PCS	M12 10 PCS
-----------------	-----------------	-----------------	-----------------	-----------------	------------------	------------------

## ESTUCHE DE REMACHES TUERCA

53360

0,45 6 24

16,00€



150  
PCS



3x9 40 PCS	4x11 35 PCS	5x13 25 PCS	6x15 25 PCS	8x18 15 PCS	10x21 10 PCS
------------------	-------------------	-------------------	-------------------	-------------------	--------------------

## ESTUCHE DE REMACHES

52043

0,98 6 12 480

16,50€



300  
PCS



4.8x16.9mm 40 PCS	4.8x24.8mm 35 PCS	
3.2x9.7mm 25 PCS	4.8x12.7mm 25 PCS	4.8x20mm 15 PCS

**DESPIECE DISPONIBLE EN BOLSAS**

REF.	MEDIDA	UDS.	€/u.
13235	M3	200	0,15€
13236	M4	200	0,15€
13237	M5	200	0,15€
13238	M6	100	0,20€
13239	M8	50	0,20€
13240	M10	40	0,40€
13241	M12	20	0,55€



## ESTUCHE REMACHES PLÁSTICOS

52711

0,44 48 384

27,50€



150  
PCS

REMACHADORA DISPONIBLE EN PÁG. 48 Y 127 (REF. 52575)



**DESPIECE DISPONIBLE EN BOLSAS**



REF.	MEDIDA	UDS.	€/u.
13674	6x19,3mm	25	0,50€
13675	6x17,8mm	25	0,50€
13676	6x25,5mm	25	0,50€
13677	6x24,5mm	25	0,50€
13678	6x24mm	25	0,50€



6x19.3mm 25 PCS	6x17.9mm 25 PCS	6x25.5mm 25 PCS
6x24.5mm 25 PCS	6x24mm 25 PCS	6x24mm 25 PCS

**DESPIECE DISPONIBLE EN BOLSAS**



REF.	MEDIDA	UDS.	€/u.
10877	4,8x16,90mm	0,04 5	500 2.000 0,25€
10878	4,8x24,80mm	0,01 10	500 1.800 0,30€
10879	3,2x9,70mm	0,02 10	500 4.000 0,20€
10880	4,8x12,70mm	0,03 10	500 2.000 0,20€
10881	4,8x20,00mm	0,04 10	500 1.480 0,25€



## ESTUCHE SURTIDO DE TORNILLOS, TUERCAS Y ARANDELAS

51804

5,68 5 120

57,50€



DESPIECE DISPONIBLE EN BOLSAS

828  
PCS

REF.	MEDIDA	UDS.	€/u.
10772	Tornillo Zincado DIN 933 8.8 M4x25	0,01 25	0,05€
10773	Tornillo Zincado DIN 933 8.8 M5x50	0,01 25	0,10€
10774	Tornillo Zincado DIN 933 8.8 M6x50	0,01 25	0,10€
10775	Tornillo Zincado DIN 933 8.8 M7x50	0,01 15	0,15€
10776	Tornillo Zincado DIN 933 8.8 M8x50	0,01 15	0,20€
10777	Tornillo Zincado DIN 933 8.8 M10x50	0,04 12	0,20€
10778	Tornillo Zincado DIN 933 8.8 M12x60	0,05 20	0,35€
10779	Tuerca Zincada DIN 934 M4	0,02 50	0,05€
10780	Tuerca Zincada DIN 934 M5	0,01 50	0,05€
10781	Tuerca Zincada DIN 934 M6	0,01 50	0,05€
10782	Tuerca Zincada DIN 934 M7	0,01 50	0,05€
10784	Tuerca Zincada DIN 934 M8	0,01 50	0,05€
10785	Tuerca Zincada DIN 934 M10	0,01 50	0,10€
10786	Tuerca Zincada DIN 934 M12	0,01 40	0,15€
10787	Arandela Zincada DIN 125 M4	0,01 50	0,05€

REF.	MEDIDA	UDS.	€/u.
10788	Arandela Zincada DIN 125 M5	0,01 50	0,05€
10789	Arandela Zincada DIN 125 M6	0,01 50	0,05€
10790	Arandela Zincada DIN 125 M7	0,01 50	0,05€
10791	Arandela Zincada DIN 125 M8	0,01 50	0,05€
10792	Arandela Zincada DIN 125 M10	0,01 50	0,05€
10783	Arandela Zincada DIN 125 M12	0,01 50	0,05€
50959	Caja 19 compartimentos	0,7 1	12,00€



## ESTUCHE DE ARANDELAS DE HIERRO GALVANIZADO 475 PIEZAS

52158

3,45 5 90

38,50€



475  
PCS

5x20x1,5mm 50 PCS	6x20x1,5mm 50 PCS	7x20x1,5mm 50 PCS	8x20x1,5mm 50 PCS
8x20x1,75mm 50 PCS	10x30x2,5mm 25 PCS	6x30x2mm 25 PCS	7x30x2mm 25 PCS
8x30x2mm 25 PCS	4x11x0,98mm 50 PCS	14x40x3mm 25 PCS	4x20x1,5mm 50 PCS



## ESTUCHE DE ARANDELAS DE HIERRO SOBREMEDIDA

53377

1,6 6 12

20,00€



20x6x1.5 20 PCS	20x8x1.5 20 PCS	20x10x1.5 20 PCS	25x6x1.5 20 PCS	25x8x1.5 20 PCS	25x10x1.5 20 PCS
32x2x1.5 20 PCS	32x4x1.5 20 PCS	32x6x1.5 20 PCS	32x8x1.5 20 PCS	32x10x1.5 20 PCS	32x10x1.5 20 PCS



240  
PCS



## ESTUCHE DE DE ARANDELAS 18 ALUMINIO

52031

0,576 24 384

40,00€



3x7x1,5mm 50 PCS	4x8x1,5mm 50 PCS	5x6x1,5mm 50 PCS	16x22x1,5mm 50 PCS	14x22x1,5mm 50 PCS	14x20x1,5mm 50 PCS
6x10x1,5mm 50 PCS	6x11x1,5mm 50 PCS	7x11x1,5mm 50 PCS	7x12x1,5mm 50 PCS	8x12x1,5mm 50 PCS	8x14x1,5mm 50 PCS
9x12x1,5mm 50 PCS	10x14x1,5mm 50 PCS	11x16x1,5mm 50 PCS	11x17x1,5mm 50 PCS	12x16x1,5mm 50 PCS	12x16x1,5mm 50 PCS



900  
PCS



## ESTUCHE DE ARANDELAS GROWNER NEGRAS

52032  
28,00€

1,68 5 870  
Kg fl



1.735  
PCS

3mm 600 PCS	4mm 400 PCS	5mm 220 PCS	6mm 220 PCS	8mm 110 PCS
10mm 65 PCS	12mm 50 PCS	14mm 40 PCS	16mm 30 PCS	

## ESTUCHE DE ARANDELAS DE COBRE PARA INYECTORES

53229  
35,00€

0,4 5 20  
Kg fl

150  
PCS



13.8x7.3x1.4mm 10 PCS	15.0x7.0x2.0mm 10 PCS	15.0x7.5x2.0mm 10 PCS	15.5x7.5x2.0mm 10 PCS	16.0x7.5x2.0mm 10 PCS
14.6x7.5x1.3mm 10 PCS	15.0x7.5x1.0mm 10 PCS	15.0x7.5x2.5mm 10 PCS	16.0x7.5x1.5mm 10 PCS	16.4x7.5x2.0mm 10 PCS
14.6x7.5x3.0mm 10 PCS	15.0x7.5x1.5mm 10 PCS	15.0x7.5x3.0mm 10 PCS	16.0x7.5x1.7mm 10 PCS	20.0x9.4x0.9mm 10 PCS

53229



DESPIECE  
DISPONIBLE

53340  
74,00€

0,9 10 1.050  
Kg fl

375  
PCS



13.8x7.3x1.4mm 25 PCS	15.0x7.0x2.0mm 25 PCS	15.0x7.5x2.0mm 25 PCS	15.5x7.5x2.0mm 25 PCS	16.0x7.5x2.0mm 25 PCS
14.6x7.5x1.3mm 25 PCS	15.0x7.5x1.0mm 25 PCS	15.0x7.5x2.5mm 25 PCS	16.0x7.5x1.5mm 25 PCS	16.4x7.5x2.0mm 25 PCS
14.6x7.5x3.0mm 25 PCS	15.0x7.5x1.5mm 25 PCS	15.0x7.5x3.0mm 25 PCS	16.0x7.5x1.7mm 25 PCS	20.0x9.4x0.9mm 25 PCS

53340



DESPIECE  
DISPONIBLE

X  
DESPIECE  
DISPONIBLE  
EN BOLSAS

13819 50 6,50€ 13.8 x 7.3 x 1.4 mm	13822 50 11,00€ 15.0 x 7.0 x 2.0 mm	13825 50 11,50€ 15.0 x 7.5 x 2.0 mm	13828 50 11,50€ 15.5 x 7.5 x 2.0 mm	13831 50 12,55€ 16.0 x 7.5 x 2.0 mm
13820 50 7,00€ 14.6 x 7.5 x 1.3 mm	13823 50 6,00€ 15.0 x 7.5 x 1.0 mm	13826 50 13,00€ 15.0 x 7.5 x 2.5 mm	13829 50 10,50€ 16.0 x 7.5 x 1.5 mm	13832 50 13,00€ 16.4 x 7.5 x 2.0 mm
13821 50 14,00€ 14.6 x 7.5 x 3.0 mm	13824 50 8,00€ 15.0 x 7.5 x 1.5 mm	13827 50 15,00€ 15.0 x 7.5 x 3.0 mm	13830 50 10,50€ 16.0 x 7.5 x 1.7 mm	13833 50 9,00€ 20.0 x 9.4 x 0.9 mm

## ESTUCHE DE ARANDELAS 18 COBRE

52030  
84,50€

1,21 6 12 384  
Kg fl

900  
PCS



50 DESPIECE DISPONIBLE

REF.	MEDIDA	€/u.
10823	3x7x1,5mm 0,01 50	0,20€
10824	4x8x1,5mm 0,01 50	0,20€
10825	5x6x1,5mm 0,01 50	0,20€
10826	16x22x1,5mm 0,01 50	0,40€
10827	14x22x1,5mm 0,01 50	0,60€
10828	14x20x1,5mm 0,01 50	0,45€
10829	6x10x1,5mm 0,01 50	0,20€
10830	6x11x1,5mm 0,01 50	0,20€
10831	7x11x1,5mm 0,01 50	0,20€
10832	7x12x1,5mm 0,01 50	0,20€
10833	8x12x1,5mm 0,01 50	0,20€
10834	8x14x1,5mm 0,01 50	0,25€
10835	9x12x1,5mm 0,01 50	0,25€
10836	10x14x1,5mm 0,01 50	0,30€
10837	11x16x1,5mm 0,01 50	0,30€
10838	11x17x1,5mm 0,01 50	0,30€
10839	12x16x1,5mm 0,01 50	0,40€
10840	12x18x1,5mm 0,01 50	0,35€



# ESTUCHE ARANDELAS DE COBRE PARA INYECTORES 551 PCS

53464

1,7 5 90

139,00€



Ø15.0X8.0X1.5 30 PCS	Ø15.0X7.0X1.5 12 PCS	Ø13.0X7.5X2.5 30 PCS	Ø15.0X7.5X1.5 30 PCS	Ø15.45X8.0X2.0 30 PCS
Ø15.45X8.0X2.0 30 PCS	Ø13.5X10X2.0 12 PCS	Ø15.5X7.5X2.5 30 PCS	Ø15.5X7.5X1.5 12 PCS	Ø15.0X7.5X3.0 30 PCS
Ø13.0X7.0X1.5 12 PCS	Ø13.5X7.5X1.5 30 PCS	Ø15.0X7.5X1.5 12 PCS	Ø15.5X7.5X1 12 PCS	Ø16.5X7.5X2 30 PCS
Ø13.7X7.3X3 12 PCS	Ø13.7X7.3X2 12 PCS	Ø10X6.0X1.0 50 PCS	Ø15.8X7.5X3.0 30 PCS	Ø8X5.8X1 30 PCS
"T" 20 PCS	"L" 30 PCS	resortes de retención 25 PCS		



30

DESPIECE DISPONIBLE

UNIVERSAL Ø15.0X8.0X1.5 13945 4,70€	MERCEDES Ø15.0X7.0X1.5 13946 6,05€	RENAULT Ø13.0X7.5X2.5 13947 5,50€
IVECO, FORD, BMW, MAN Ø15.0X7.5X1.5 13948 4,70€	UNIVERSAL Ø15.45X8.0X2.0 13949 6,50€	UNIVERSAL Ø15.45X8.0X2.0 13950 7,30€
MAZDA Ø13.5X10X2.0 13951 5,15€	FORD Ø15.5X7.5X2.5 13952 9,50€	LAND ROVER Ø15.5X7.5X1.5 13953 7,00€
RENAULT Ø15.0X7.5X3.0 13954 11,00€	DEUTZ Ø13.0X7.0X1.5 13955 4,70€	FORD Ø13.5X7.5X1.5 13956 4,10€
FIAT Ø15.0X7.5X1.5 13957 6,40€	MAN ROVER Ø15.5X7.5X1 13958 5,15€	MERCEDES Ø16.5X7.5X2 13959 8,65€
KIA Ø13.7X7.3X3 13960 9,00€	KIA Ø13.7X7.3X2 13961 8,60€	ACERO Ø10X6.0X1.0 13962 1,80€
LATÓN Ø15.8X7.5X3.0 13963 11,50€	CONECTOR DE MANGUERA "T" 13964 13,00€	ALUMINIO Ø8X5.8X1 13965 1,50€
CONECTOR DE MANGUERA "L" 13966 12,90€	RESORTES DE RETENCIÓN 13967 4,65€	

551 PCS



# ARANDELAS DE TAPÓN DE CÁRTER METALOPLÁSTICA

Ø 10MM / 0,02KG 52719 0,19€/u.	0,04 100 5.000
Ø 12MM / 0,03KG 51843 0,19€/u.	0,01 100 5.000

GOMA (Ford) Ø 13MM / 0,01KG 51554 0,28€/u.	0,01 100 5.000
Ø 14MM / 0,01KG 51546 0,19€/u.	0,01 100 5.000

Ø 16MM / 0,01KG 51799 0,20€/u.	0,01 100 2.500
--------------------------------------	----------------

# ESTUCHE DE ARANDELAS DE COBRE PARA TAPÓN DE CÁRTER

52163

86,00€

0,65  
6  
12  
400



DESPIECE DISPONIBLE



ARANDELAS DE TAPÓN DE CÁRTER

REF.	MEDIDA	€ / u.
51538	Ø10mm / 0,01kg	0,15€
51539	Ø12mm / 0,01kg	0,15€
51540	Ø14mm / 0,01kg	0,15€
51541	Ø16mm / 0,01kg	0,25€
51542	Ø18mm / 0,01kg	0,20€
51543	Ø20mm / 0,01kg	0,25€
51544	Ø22mm / 0,02kg	0,25€
51545	Ø26mm / 0,02kg	0,30€

Ø10MM 100 PCS	Ø12MM 100 PCS	Ø14MM 100 PCS
Ø16MM 100 PCS	Ø18MM 100 PCS	Ø20MM 25 PCS

COMPRESIBLE





## ESTUCHE DE ARANDELAS DE COBRE

53353

18,00€

0,2 Kg 6 24

110 PCS



	M6	M8	M10	M12	M14	M16
	30 PCS	25 PCS	20 PCS	15 PCS	10 PCS	10 PCS

## ESTUCHE DE ARANDELAS DENTADAS INTERIOR

53373

14,50€

0,25 Kg 6 24

260 PCS



	M3x10	M4x12	M5x14	M6x14	M8x18	M10x20	M12x25
	30 PCS	30 PCS	40 PCS	50 PCS	50 PCS	40 PCS	20 PCS

## ESTUCHE DE ARANDELAS SEGER EXTERIORES

53383

11,50€

0,2 Kg 6 24

300 PCS



	M4	M6	M8	M10	M12
	50 PCS	40 PCS	45 PCS	30 PCS	30 PCS
	M14	M16	M18	M20	M22
	25 PCS	25 PCS	25 PCS	15 PCS	15 PCS

## ESTUCHE DE ARANDELAS SEGER INTERIORES

53382

11,00€

0,15 Kg 6 24

300 PCS

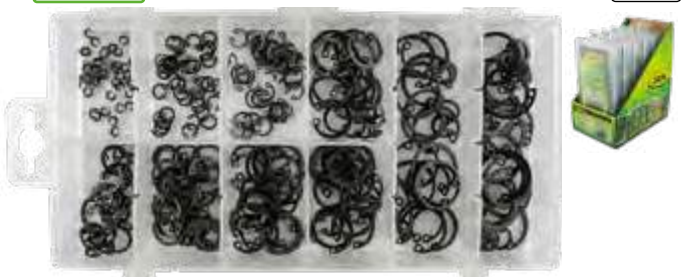

	M4	M6	M8	M10	M12
	50 PCS	40 PCS	45 PCS	30 PCS	30 PCS
	M14	M16	M18	M20	M22
	25 PCS	25 PCS	25 PCS	15 PCS	15 PCS

## SURTIDO DE ARANDELAS DE FIBRA

53381

14,50€

0,25 Kg 6 12

600 PCS



	10x5.5x1	16x10x1	19x12x1	22x16x1	22.5x14x1	32x22x1
	160 PCS	80 PCS	40 PCS	30 PCS	20 PCS	20 PCS
	12x6.5x1	16x8x1	20x12.5x1	27x20x1	25.4x17.5x1	32x24x1
	100 PCS	60 PCS	40 PCS	20 PCS	15 PCS	15 PCS

## ESTUCHE DE OBUSES PARA AA/CC

53599

29,00€

0,15 Kg 10 100

134 PCS





### DESPIECE DISPONIBLE

REF.	MEDIDA	0,01	10	€./u.
14594	5x19mm R12 (verde)	0,01	10	2,00€
14595	5x19mm	0,01	10	1,50€
14596	5x19mm R12	0,01	10	2,00€
14597	6x19mm	0,01	10	7,60€
14598	6x26.5mm	0,01	10	17,80€
14599	7x20mm R134A	0,01	10	4,50€
14600	6x22mm	0,01	10	9,50€
14601	8x22mm	0,01	10	11,00€
14602	9x22mm	0,01	10	11,00€

# ESTUCHE DE JUNTAS TÓRICAS

MÉTRICAS - 386 UNIDADES

TAPA DEL ESTUCHE	Posición del estuche	006	007	008	009	010	011
	Ancho de goma (mm)	2	2	2	2	2	2
	Ø Interior (mm)	3	4	5	6	7	8
	Cantidad	16	16	16	16	16	16

TAPA DEL ESTUCHE	Posición del estuche	113	112	111	110	012
	Ancho de goma (mm)	2.5	2.5	2.5	2.5	2
	Ø interior (mm)	14	12	11	10	10
	Cantidad	13	13	13	13	17

BASE DEL ESTUCHE	Posición del estuche	222	325	326	327
	Ancho de goma (mm)	3	4	4	4
	Ø Interior (mm)	38	38	41	44
	Cantidad	12	10	9	9

BASE DEL ESTUCHE	Posición del estuche	221	220	219	218	217
	Ancho de goma (mm)	3	3	3	3	3
	Ø interior (mm)	36	35	33	32	30
	Cantidad	12	12	12	12	12

BASE DEL ESTUCHE	Posición del estuche	211	212	213	214	215	216
	Ancho de goma (mm)	3	3	3	3	3	3
	Ø interior (mm)	20	22	24	25	27	28
	Cantidad	12	12	12	12	12	12

**50651**

16,50€



**386**  
PCS



CALIDAD  
HNBR

PULGADAS - 386 UNIDADES

TAPA DEL ESTUCHE	Posición del estuche	006	007	008	009	010	011
	Ancho de goma	1/16	1/16	1/16	1/16	1/16	1/16
	Ø interior	1/8	5/32	3/16	7/32	1/4	5/16
	Cantidad	20	20	20	20	20	20

TAPA DEL ESTUCHE	Posición del estuche	113	112	111	110	012
	Ancho de goma	3/32	3/32	3/32	3/32	1/16
	Ø interior	9/16	1/2	7/16	3/8	3/8
	Cantidad	13	13	13	13	13

BASE DEL ESTUCHE	Posición del estuche	222	325	326	327
	Ancho de goma	1/8	3/16	3/16	3/16
	Ø interior	11/2	11/2	15/8	13/4
	Cantidad	10	7	7	7

BASE DEL ESTUCHE	Posición del estuche	221	220	219	218	217
	Ancho de goma	1/8	1/8	1/8	1/8	1/8
	Ø interior	17/16	13/8	15/16	11/4	13/16
	Cantidad	10	10	10	10	10

BASE DEL ESTUCHE	Posición del estuche	211	212	213	214	215	216
	Ancho de goma	1/8	1/8	1/8	1/8	1/8	1/8
	Ø interior	13/16	7/8	15/16	1	11/16	11/8
	Cantidad	10	10	10	10	10	10

**50652**  
16,50€



CALIDAD  
HNBR



# ESTUCHE DE JUNTAS TÓRICAS PARA AACC

**50807**

35,00€



5.29X1.78MM 20 PCS	6.07x1.78mm 20 PCS	6.8x1.9mm 20 PCS	<b>270</b> PCS	
7.65x1.78mm 20 PCS	7.80x1.90mm 20 PCS	8.0X2.0MM 20 PCS	8.80X1.90MM 20 PCS	10.82X1.78MM 15 PCS
10.77X2.62MM 15 PCS	11.0X2.0MM 15 PCS	12.0X2.0MM 15 PCS	13.9x1.80mm 10 PCS	13.95x2.62mm 10 PCS
14.0X2.0MM 10 PCS	15.0X2.0MM 10 PCS	17.0X2.00MM 10 PCS	17.17x1.778mm 10 PCS	17.04x3.53mm 10 PCS

# ESTUCHE DE TUBOS TERMORETRÁCTILES

**53374**

10,00€



**53376**

10,50€



**53376**



**127**  
PCS

**53374**

SOPLETE DE GAS

**51920**

18,00€



VER PÁG. 261



M2x40 30 PCS	M2.5x40 25 PCS	M3.5x40 20 PCS	M5x40 20 PCS	M7x80 16 PCS	M10x80 8 PCS	M13x85 8 PCS
-----------------	-------------------	-------------------	-----------------	-----------------	-----------------	-----------------



## SET DE MANGUITOS DE SOLDADURA TERMORETRACTILES 100 PCS

**53992**  
16,00€

0,10 6 84 1.512

- Permite una conexión fácil y rápida de cables, soldado y sellado mediante la colocación de los cables en el manguito de soldadura para una posterior aplicación de calor.  
- Material anillo de soldado: estaño  
- Material: PE

**100**  
PCS



Ø1.7mm 0.25-0.34mm <sup>2</sup> 26-24 AWG <b>25</b> PCS	Ø2.7mm 0.5-1.0mm <sup>2</sup> 22-18 AWG <b>35</b> PCS	Ø4.7mm 1.5-2.5mm <sup>2</sup> 16-14 AWG <b>30</b> PCS	Ø6.0mm 4.0-6.0mm <sup>2</sup> 12-10 AWG <b>10</b> PCS
---	---	---	---

## ESTUCHE DE CONECTORES DE MANGUERA

**53910**  
17,50€

Kg 0,23  
6  
24

RECTO			REDUCTOR	
4.8x4.8 <b>10</b> PCS	6.3x6.3 <b>8</b> PCS	3.17x3.17 <b>30</b> PCS	9.5x6.3 <b>6</b> PCS	6.3x4.8 <b>10</b> PCS
7.9x7.9 <b>6</b> PCS	9.5x9.5 <b>6</b> PCS			
en T				
3.9x3.9x3.9 <b>8</b> PCS	4.8x4.8x4.8 <b>8</b> PCS	3.17x3.17x3.17 <b>12</b> PCS		
6.3x6.3x6.3 <b>6</b> PCS	9.5x9.5x9.5 <b>3</b> PCS			



**113**  
PCS



**53434**  
18,00€

Kg 0,15  
6  
24  
720

4x28.7 <b>10</b> PCS	3.9x30.8 <b>5</b> PCS	10.4x44.4 <b>10</b> PCS	5.6x47.1 <b>5</b> PCS
7.9x38 <b>10</b> PCS	4.7x38.9 <b>5</b> PCS	5.2x33.9 <b>10</b> PCS	7x30 <b>10</b> PCS



**65**  
PCS



## ESTUCHE DE ENGRASADOR

**52033**  
37,50€

0,89 6 24 720

DESPIECE DISPONIBLE



ÁNGULO RECTO

REF.	MEDIDA	€/u.
10868	6x1 0,01 10	0,30€
10869	8x1 0,01 15	0,30€
10870	10x1 0,01 10	0,45€

**135**  
PCS

ÁNGULO 90°

REF.	MEDIDA	€/u.
10874	6x1 0,01 20	0,30€
10875	8x1 0,01 15	0,40€
10876	10x1 0,01 10	0,45€

ÁNGULO 45°

REF.	MEDIDA	€/u.
10871	6x1 0,01 20	0,30€
10872	8x1 0,01 15	0,40€
10873	10x1 0,01 10	0,45€



## SURTIDO DE ENGRASADORES

**53359**  
14,50€

0,5 6 24

6x1 <b>5</b> PCS	6x1 <b>60</b> PCS	6x1 <b>5</b> PCS
8x1.25 <b>5</b> PCS	8x1.25 <b>10</b> PCS	8x1.25 <b>5</b> PCS
10x1.5 <b>5</b> PCS	10x1.5 <b>10</b> PCS	10x1.5 <b>5</b> PCS



**110**  
PCS



## SURTIDO DE ABRAZADERAS DE TUBO

**53378**  
13,00€

0,45 6 24  
Kg

1"	1-1/4"	1-3/4"	2"
4 PCS	2 PCS	2 PCS	4 PCS
2-1/2"	3"	3-1/2"	4"
2 PCS	2 PCS	2 PCS	2 PCS



**20**  
PCS



## ESTUCHE DE MUELLES

**53358**  
11,50€

0,25 6 24  
Kg



5/16x1-3/4	9/32x1/2	1/4x13/32	7/32x11/16	7/32x1-1/2
5 PCS	5 PCS	5 PCS	5 PCS	5 PCS
	3/8x5/8	3/8x3/4	23/64x1-3/8	9/32x3/4
	5 PCS	5 PCS	5 PCS	5 PCS
	13/64x13/16	7/32x1	1/4x7/8	5/16x1-1/8
	10 PCS	10 PCS	10 PCS	8 PCS
	3/16x1-3/4	9/32x1-1/2	11/32x1-7/16	11/32x1-27/32
	8 PCS	10 PCS	10 PCS	12 PCS
				9/32x2
				12 PCS
				5/32x3-1/8
				12 PCS

**200**  
PCS



## SET DE 2 PINZAS DE COCODRILO

**53357**  
7,00€

0,01 6 24  
Kg



**2**  
PCS  
30 AMP



## ESTUCHE DE FUSIBLES MINI

**53355**  
11,50€

0,15 6 24 672  
Kg



5A	10A	15A	20A	25A	30A
20 PCS	20 PCS	20 PCS	20 PCS	20 PCS	20 PCS

**120**  
PCS



## ESTUCHE DE FUSIBLES

**53356**  
11,50€

0,25 6 24  
Kg



15A
20 PCS

5A	10A
20 PCS	20 PCS

20A	25A	30A
20 PCS	20 PCS	20 PCS

### DESPIECE DISPONIBLE

REF.	MEDIDA	€./u.
10915	5A 0,01 20	0,25€
10917	10A 0,01 20	0,30€
10918	15A 0,01 20	0,30€
10919	20A 0,01 20	0,30€
10920	25A 0,01 20	0,25€
10921	30A 0,01 20	0,30€



**120**  
PCS



## ESTUCHE DE FUSIBLES

**53367**  
9,50€

0,10 6 24 1.608  
Kg



**48**  
PCS

5A	10A	15A	20A	25A	30A
8 PCS	8 PCS	8 PCS	8 PCS	8 PCS	8 PCS

## ESTUCHE DE FUSIBLES

**53368**  
9,00€

0,10 6 24  
Kg



**50**  
PCS

Mini fusibles

5A	10A	15A	20A	25A	30A
8 PCS	8 PCS	8 PCS	8 PCS	8 PCS	10 PCS



## ESTUCHE DE MINI FUSIBLES

53380

0,17 6 24

11,50€

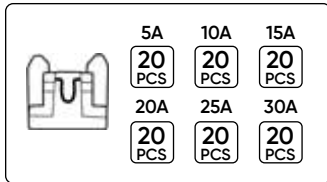

120 PCS



## ESTUCHE DE FUSIBLES

52054

0,35 6 24 750

15,50€



DESPIECE DISPONIBLE

252 PCS



MINI XXA

REF.	COLOR	POTENCIA	€/u.
10905	Blue	3A, 0,01 20	0,25€
10906	Red	4A, 0,01 20	0,25€
10907	Brown	5A, 0,01 20	0,25€

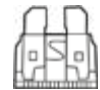

STANDARD XXA

REF.	COLOR	POTENCIA	€/u.
10914	Pink	4A, 0,01 20	0,25€
10915	Yellow	5A, 0,01 20	0,25€
12954	Purple	3A, 0,01 20	0,25€

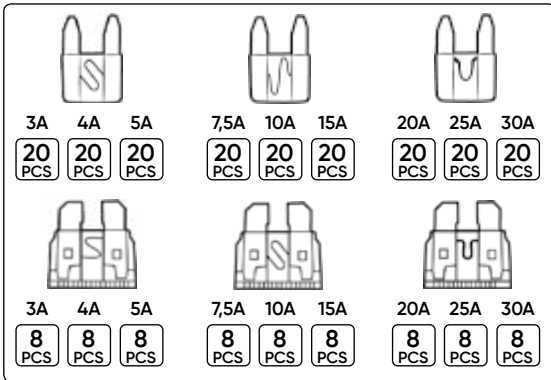

MINI XXA

REF.	COLOR	POTENCIA	€/u.
10908	Yellow	7,5A, 0,01 20	0,30€
10909	Pink	10A, 0,01 20 1000	0,30€
10910	Purple	15A, 0,01 20	0,30€



STANDARD XXA

REF.	COLOR	POTENCIA	€/u.
10916	Brown	7,5A, 0,01 20	0,30€
10917	Red	10A, 0,01 20 4000	0,30€
10918	Blue	15A, 0,01 20 3500	0,30€



MINI XXA

REF.	COLOR	POTENCIA	€/u.
10911	Yellow	20A, 0,01 20 1000	0,30€
10912	Grey	25A, 0,01 20	0,25€
10913	Green	30A, 0,01 20	0,30€



STANDARD XXA

REF.	COLOR	POTENCIA	€/u.
10919	Yellow	20A, 0,01 20 2000	0,30€
10920	Grey	25A, 0,01 20 2000	0,25€
10921	Green	30A, 0,01 20 2000	0,30€

## ESTUCHE DE TERMINALES 635 PIEZAS

52053

0,6 6 24 800

38,50€



REF.	COLOR	POTENCIA	€/u.
10885	Red	RV1.25-4S, 0,01 20	0,20€
10886	Blue	RV2-4S, 0,01 20	0,20€
10887	Blue	RV2-6S, 0,01 20	0,25€
10888	Yellow	RV5.5-6S, 0,01 20	0,30€
10889	Yellow	RV5.5-5S, 0,01 20	0,30€
10893	Blue	RV2-5S, 0,01 20	0,25€

DESPIECE DISPONIBLE



635 PCS

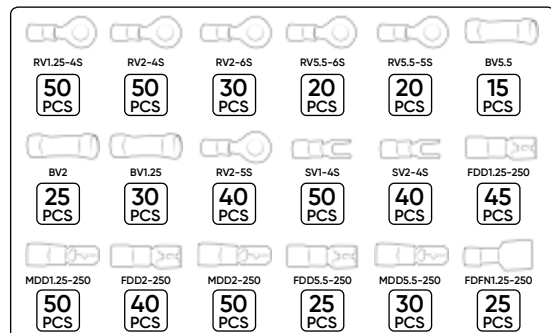

REF.	COLOR	POTENCIA	€/u.
10890	Yellow	BV5.5, 0,01 20	0,35€
10891	Blue	BV2, 0,01 20	0,25€
10892	Red	BV1.25, 0,01 20	0,30€



REF.	COLOR	POTENCIA	€/u.
10894	Red	SV1-4S, 0,01 20	0,20€
10895	Blue	SV2-4S, 0,01 20	0,20€



REF.	COLOR	POTENCIA	€/u.
10896	Red	FDD1.25-250, 0,01 20 2000	0,30€
10898	Blue	FDD2-250, 0,01 20 1500	0,30€
10900	Yellow	FDD5.5-250, 0,01 20 2000	0,30€



REF.	COLOR	POTENCIA	€/u.
10902	Purple	FDFN 1.25-250, 0,01 20 2000	0,30€



REF.	COLOR	POTENCIA	€/u.
10897	Red	MDD1.25-250, 0,01 20	0,30€
10899	Blue	MDD2-250, 0,01 20 3000	0,30€
10901	Yellow	MDD5.5-250, 0,01 20	0,25€

ALICATES PARA TERMINALES



VER PÁG. 59

# ESTUCHES DE CLIPS PLÁSTICOS

UNIDADES EN EL ESTUCHE



UNIDADES POR BOLSA RECAMBIO

BOLSAS POR SUBCAJA / CAJA



DESPIECE DISPONIBLE

## PARA MAZDA

**52896**  
24,00€

**190**  
PCS

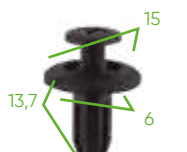

**13104** 8 8  
1,90€  
OE 2042301

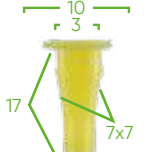

**13105** 15 15  
2,50€  
OE 999100402

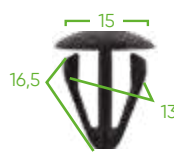

**13106** 8 8  
2,00€  
OE B0016830200

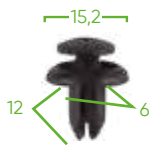

**13107** 8 10  
2,15€  
OE N30413356A



**13108** 20 20  
1,90€  
OE 992640543A



**13109** 30 30  
2,90€  
OE 99249051B

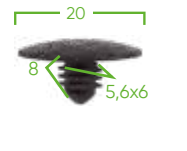

**13110** 15 15  
1,85€  
OE 6508197AA

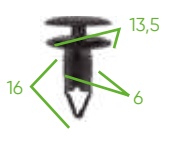

**13111** 10 10  
1,20€  
OE B1016825200

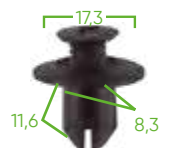

**13112** 6 6  
1,65€  
OE B09251833



**13113** 20 20  
2,20€  
OE 992640543A

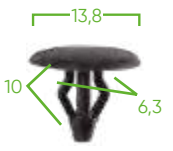

**13114** 20 20  
2,20€  
OE B45556741

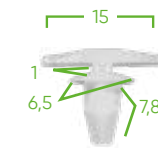

**13115** 30 30  
2,50€  
OE G03158762

## PARA TOYOTA / LEXUS

**52886**  
18,00€

**89**  
PCS

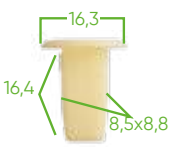

**13002** 8 8  
1,45€  
OE 9018906001



**13003** 5 4  
1,70€  
OE 9046707138

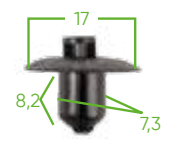

**13004** 10 10  
1,85€  
OE 9046707117

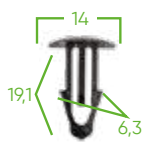

**13005** 10 10  
1,25€  
OE 9046709138

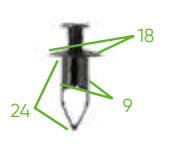

**13006** 5 5  
1,40€  
OE 9046709101



**13007** 10 10  
1,30€  
OE 75521611000

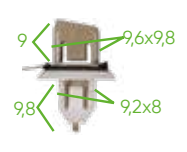

**13008** 8 8  
2,25€  
OE 7503933060

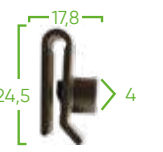

**13009** 4 4  
1,65€  
OE 9017905060

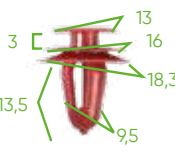

**13010** 8 8  
1,75€  
OE 677711250

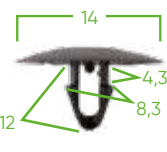

**13011** 5 5  
1,15€  
OE 9046708124



**13012** 8 8  
1,80€  
OE 7539533030



**13013** 8 8  
1,75€  
OE 9046711063

## PARA HONDA

**52887**  
22,00€

**150**  
PCS

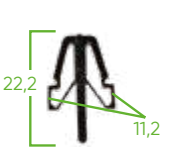

**13014** 12 12  
1,45€  
OE 75103S.J4003

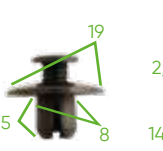

**13015** 5 5  
1,20€  
OE 90675SB003

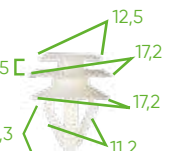

**13016** 6 6  
1,15€  
OE 91566SP0003



**13017** 25 25  
2,60€  
OE 91513SE003



**13018** 25 25  
1,45€  
OE 91530ST5003

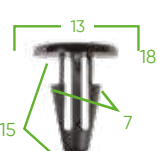

**13019** 15 15  
1,75€  
OE 90687SA50030



**13020** 8 8  
1,70€  
OE 91620SR2003

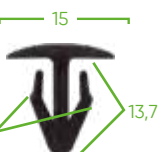

**13021** 8 8  
1,30€  
OE 38529689A6300

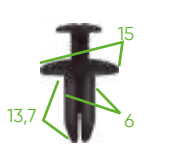

**13022** 10 10  
2,10€  
OE 90683SA5003

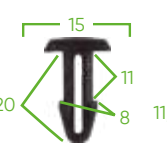

**13023** 10 10  
1,50€  
OE 90672671003

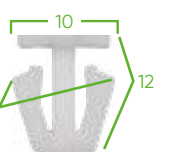

**13024** 18 18  
2,45€  
OE 91534SE0000

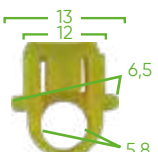

**13025** 8 8  
1,50€  
OE 34355SD2003



## PARA PEUGEOT / CITROËN

52899  
34,00€

345  
PCS



0,5 6 24 360  
Kg

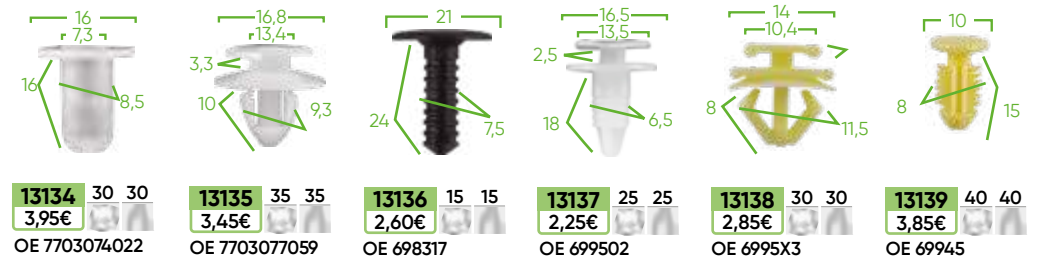
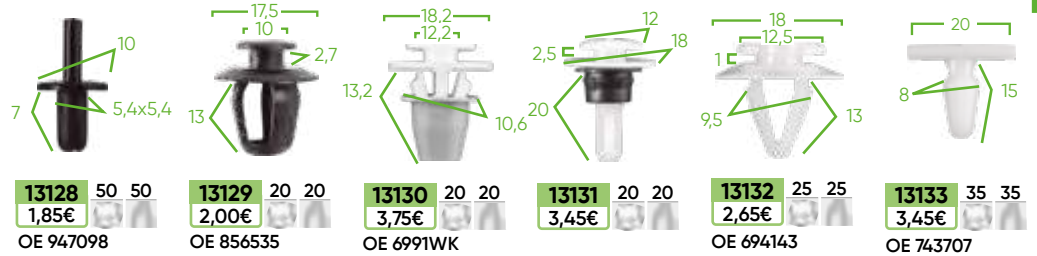

## PARA FIAT

52900  
34,00€

308  
PCS



0,5 6 24 360  
Kg

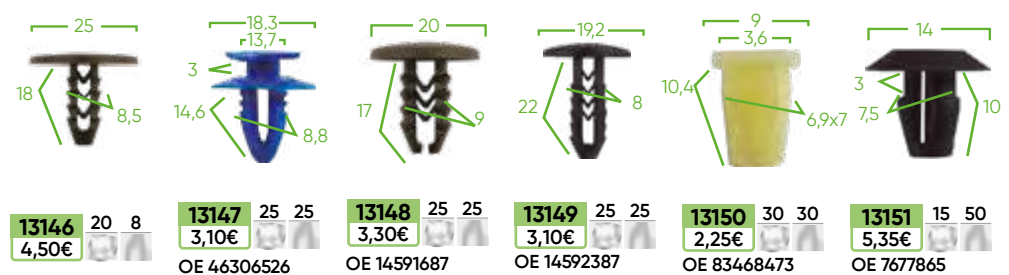
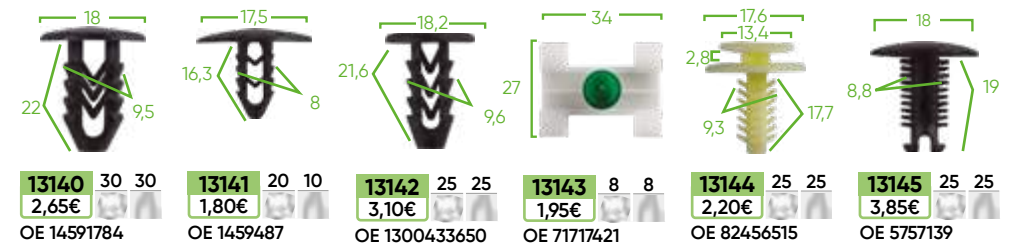

## PARA VOLVO

52901  
34,00€

350  
PCS



0,48 6 24 1.500  
Kg

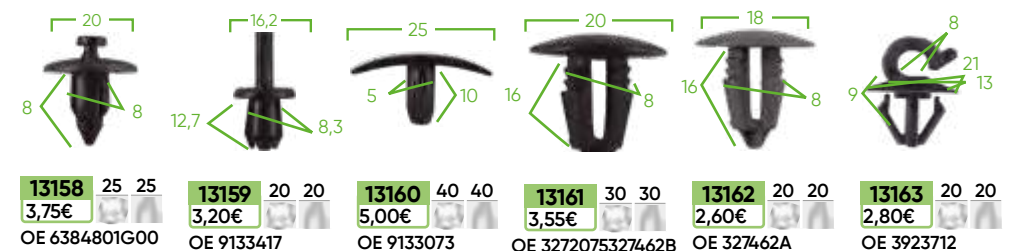
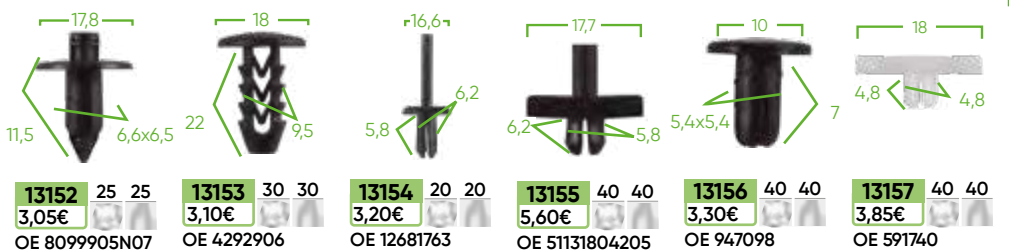

# ESTUCHES DE CLIPS PLÁSTICOS

## PARA VOLSKWAGEN

**52889**  
19,00€

**85**  
PCS



0,18 6 24 504  
Kg

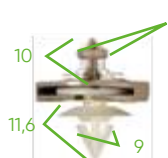

**13038** 2 2  
1,40€  
OE 1H0868243B

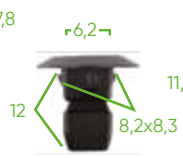

**13039** 10 10  
1,65€  
OE N90833801



**13040** 8 8  
1,80€  
OE 3A0853575



**13041** 5 5  
1,55€  
OE 4A0853825



**13042** 15 15  
1,95€  
OE 6U085733

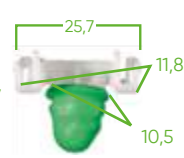

**13043** 3 3  
1,20€  
OE 3B0853576



**13044** 6 6  
1,55€  
OE 1H0819055B01C

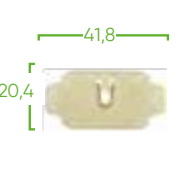

**13045** 5 5  
1,20€  
OE 443853909A

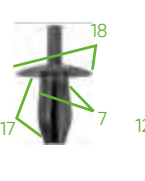

**13046** 6 6  
1,55€  
OE 171885767

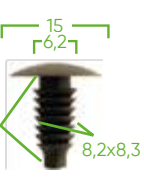

**13047** 5 5  
1,45€  
OE N9020160H



**13048** 10 10  
2,20€  
OE N0385501



**13049** 10 10  
2,05€  
OE 191941142

## PARA BMW

**52892**  
22,00€

**95**  
PCS



0,17 6 24 672  
Kg

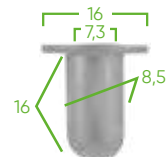

**13068** 25 25  
2,85€  
OE 51311802258

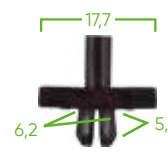

**13069** 30 30  
4,55€  
OE 51131804205

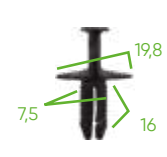

**13070** 10 10  
2,15€  
OE 51118174185

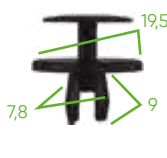

**13071** 10 10  
2,05€  
OE 51481938725

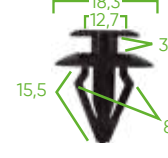

**13072** 15 15  
2,75€  
OE 703867299



**13073** 5 5  
2,10€  
OE 51131960054

## PARA NISSAN

**52894**  
22,00€

**139**  
PCS



0,19 6 24 216  
Kg

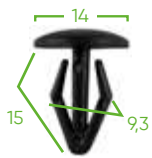

**13080** 15 15  
1,75€  
OE 76906T300



**13081** 20 20  
2,30€  
OE 0155300172

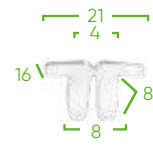

**13082** 10 10  
1,35€  
OE 68425H5000

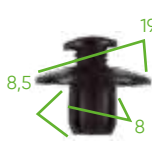

**13083** 6 6  
1,50€  
OE 75521611000

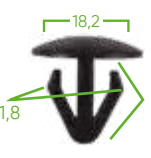

**13084** 20 20  
2,10€  
OE 62869N4700



**13085** 5 5  
1,60€  
OE 6384401A00

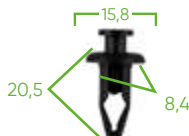

**13086** 12 5  
1,25€  
OE 7688257A00



**13087** 25 25  
3,30€  
OE 6684101G00

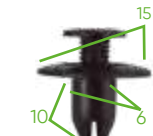

**13088** 10 10  
2,40€  
OE 1099830880



**13089** 10 10  
1,70€  
OE 8942798070



**13090** 8 8  
1,70€  
OE 6384801G00



**13091** 5 5  
1,25€  
OE 6385401A00



# ESTUCHES DE CLIPS PLÁSTICOS

UNIDADES EN EL ESTUCHE

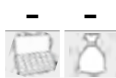

UNIDADES POR BOLSA RECAMBIO



10 100



DESPIECE DISPONIBLE

## PARA AUDI

**52890**  
22,00€

**31**  
PCS



0,16 6 24 504



**13053** 10 10  
2,80€  
OE 357853575

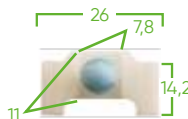

**13054** 5 5  
2,35€  
OE 1H0853585A

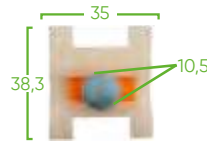

**13055** 3 3  
3,00€  
OE 3A0853575

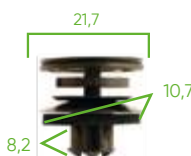

**13050** 5 5  
1,55€  
OE 3B0868243

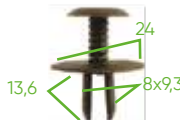

**13051** 5 5  
1,50€  
OE 1H0867199A



**13052** 3 3  
1,25€  
OE 1H0868243B

## PARA FORD

**52891**  
28,00€

**169**  
PCS



0,16 6 24 672



**13056** 8 8  
1,55€  
OE 388577S

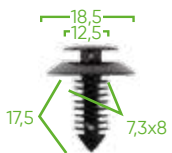

**13057** 5 5  
1,50€  
OE N801925S

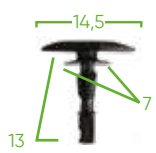

**13058** 20 20  
2,20€  
OE N806289S

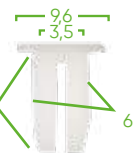

**13059** 20 20  
2,35€  
OE N379830S



**13060** 5 5  
1,60€  
OE 1007932



**13061** 20 20  
2,65€  
OE 16500308

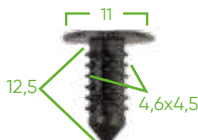

**13062** 20 20  
2,35€  
OE N803170S

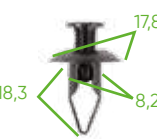

**13063** 6 6  
1,15€  
OE W706713S300

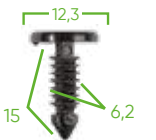

**13064** 20 20  
2,60€  
OE N388246S



**13065** 15 15  
2,00€  
OE F22Z16774A



**13066** 5 5  
2,25€  
OE 1673046



**13067** 25 25  
2,55€  
OE FICZ16674A

## PARA BENZ

**52893**  
26,00€

**95**  
PCS



0,2 6 24 504

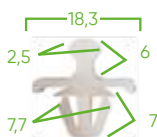

**13074** 30 30  
4,65€  
OE A0019884481



**13075** 20 20  
5,35€  
OE A0019882981

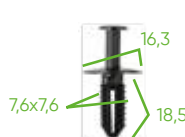

**13076** 15 15  
3,90€  
OE A1249900492



**13077** 4 4  
2,55€  
OE A0019888081



**13078** 6 6  
2,55€  
OE A1249880492



**13079** 20 20  
3,35€  
OE A0019880325

# ESTUCHES DE CLIPS PLÁSTICOS

## PARA RENAULT

**52897**  
38,00€ **300**  
PCS



0,43 6 24 360  
Kg



**13116** 50 50  
5,45€  
OE 7703077421

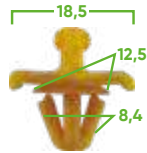

**13117** 50 50  
3,65€



**13118** 60 60  
15,85€  
OE 7703081184

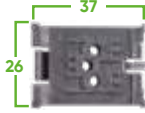

**13119** 15 15  
5,60€



**13120** 60 60  
5,50€  
OE 7703074022



**13121** 65 65  
8,75€  
OE 7703077059

## PARA MITSUBISHI

**52895**  
22,00€ **132**  
PCS



0,19 6 24 1.500  
Kg



**13092** 15 15  
1,65€  
OE 8942180270

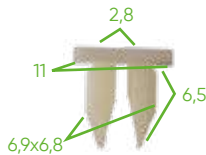

**13093** 30 30  
2,95€  
OE 9018905013



**13094** 10 10  
1,50€  
OE MU480033

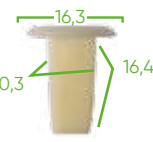

**13095** 6 6  
1,20€  
OE 128100231



**13096** 8 8  
1,70€  
OE MU480034

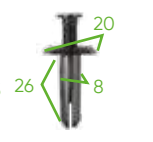

**13097** 3 3  
1,20€  
OE MR138807



**13098** 4 4  
1,65€  
OE MB253964



**13099** 30 30  
2,75€  
OE HB121467



**13100** 3 3  
1,20€  
OE MB271999



**13101** 8 8  
1,50€  
OE MB696120



**13102** 5 5  
1,60€  
OE MR200300



**13103** 10 10  
1,80€  
OE MB846992

## PARA VAUXHALL / OPEL

**52898**  
36,00€ **300**  
PCS



0,45 6 24 360  
Kg



**13122** 20 20  
1,95€  
OE 90218614

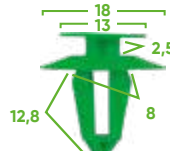

**13123** 40 40  
5,35€  
OE 174864

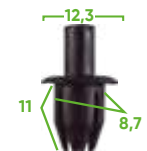

**13124** 100 100  
8,20€  
OE N0385501

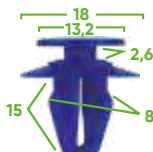

**13125** 50 50  
5,95€  
OE 2345959

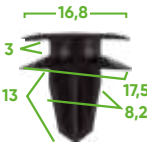

**13126** 50 50  
1,55€  
OE 2240582



**13127** 40 40  
5,60€  
OE 180942



# ESTUCHES DE CLIPS PLÁSTICOS

## UNIVERSAL

**52888**  
24,00€

**128**  
PCS



0,14 6 24 672

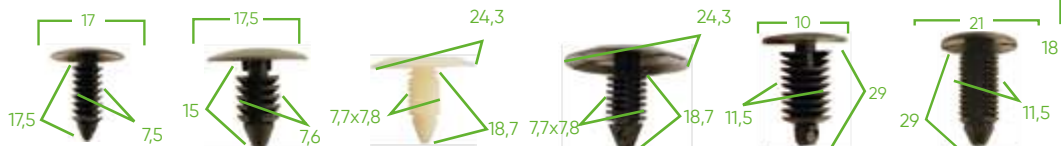

**13026** 8 8  
1,55€  
OE 3885775

**13027** 10 10  
1,85€  
GENERAL USE

**13028** 6 6  
1,45€  
OE 6003423

**13029** 6 6  
1,65€  
VW: N989022  
CHRYSLER: 6003349  
FORD: 385661

**13030** 25 25  
2,80€  
GM: 20699808  
CHRYSLER: 6502328

**13031** 4 4  
1,85€  
FORD: N8043795

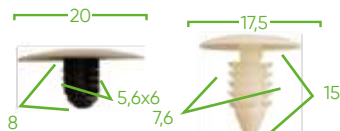

**13032** 15 15  
2,00€  
MAZDA: 6508197AA  
FORD: F22Z16774A

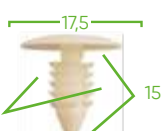

**13033** 10 10  
1,60€  
GM: 16674629  
FORD: N8061135



**13034** 20 20  
2,65€  
NISSAN: 0153301781



**13035** 6 6  
1,65€  
GM: 10124502  
CHRYSLER: 52201964201  
LAND ROVER:  
DZM100080

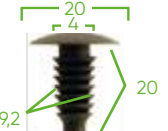

**13036** 6 6  
1,40€  
VW: N9020160H  
FORD: 6998849  
BMW: 51471904317  
OPEL: 2207713

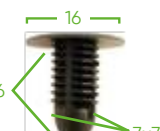

**13037** 12 12  
2,10€  
GENERAL USE

## PARA BMW MINI PARA TAPICERÍA

**53720**  
19,00€

**112**  
PCS



0,18 6 24 216



**14447** 7 6  
1,45€  
OE 51471911992

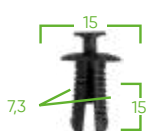

**14449** 13 10  
2,20€  
OE A0009905492

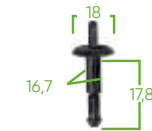

**14471** 5 5  
1,90€  
OE 51717002953

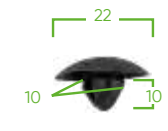

**14472** 5 5  
1,35€  
OE 51489119216

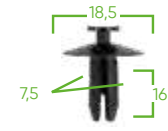

**14474** 8 8  
1,50€  
OE 51118174185



**14475** 6 6  
1,65€  
OE 2019900050

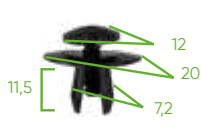

**14476** 9 9  
2,05€  
OE 51481915964



**14477** 15 15  
2,45€  
OE 0009881625



**14478** 15 15  
4,05€  
OE 7146976114

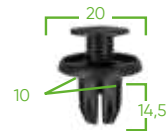

**14479** 6 6  
1,65€  
OE 91503SP0003

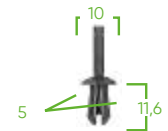

**14480** 15 15  
2,05€



**14481** 8 8  
1,70€  
OE 51161943122

## PARA BMW MINI PARA PANEL DE PUERTA / MOLDURA

**53719**  
19,00€

**92**  
PCS



0,16 6 24 216

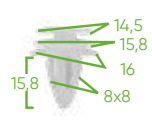

**14359** 8 4  
1,05€  
OE 51418224768

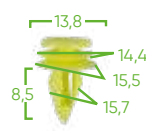

**14458** 8 8  
1,70€



**14459** 6 6  
1,45€

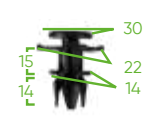

**14460** 2 2  
1,15€  
OE 7147122912

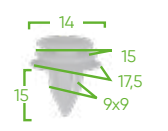

**14461** 8 8  
1,35€  
OE 51411973500

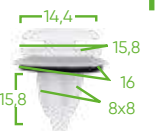

**14462** 8 8  
1,65€

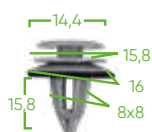

**14463** 8 8  
1,65€



**14464** 10 10  
1,50€  
OE 611769

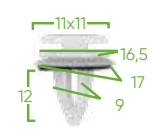

**14465** 10 10  
2,00€  
OE 7147145753

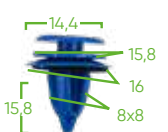

**14466** 8 8  
1,65€

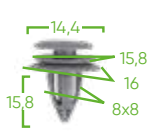

**14468** 8 8  
1,30€

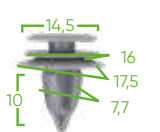

**14469** 8 8  
1,45€  
OE 7147133419

# ESTUCHES DE CLIPS PLÁSTICOS

UNIDADES EN EL ESTUCHE



UNIDADES POR BOLSA RECAMBIO



DESPIECE DISPONIBLE

## PARA MERCEDES-BENZ PARA TAPICERÍA

**53718**  
19,00€

**151**  
PCS

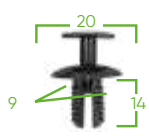

**14422** 6 6  
1,50€  
OE A0009913940

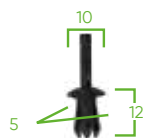

**14446** 20 20  
2,80€  
OE 9903492

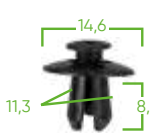

**14447** 6 6  
1,45€  
OE 51471911992

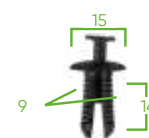

**14448** 12 12  
2,05€  
OE N105835019B9

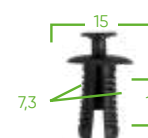

**14449** 10 10  
2,20€  
OE A0009905492



**14450** 12 12  
2,15€  
OE NO385012

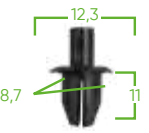

**14451** 12 12  
2,15€  
OE A1239900092



**14452** 25 25  
2,55€

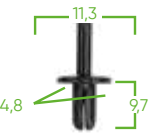

**14453** 20 20  
3,05€

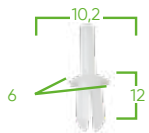

**14455** 12 12  
2,10€



**14456** 6 6  
1,35€



**14457** 10 10  
1,70€  
OE A1249900492

0,18 6 24 216  
Kg

## PARA MERCEDES-BENZ PARA PANEL DE PUERTA / MOLDURA

**53717**  
19,00€

**96**  
PCS

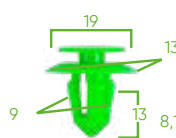

**14434** 8 8  
1,60€

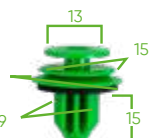

**14435** 6 6  
1,45€

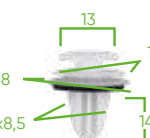

**14436** 8 8  
1,70€  
OE A0009910198



**14437** 6 6  
1,45€  
OE A0019912698

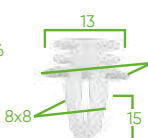

**14438** 8 8  
1,35€  
OE A0089880978

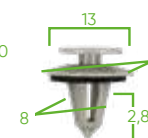

**14439** 8 8  
1,75€  
OE 0069884378

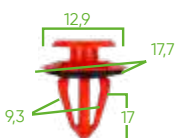

**14440** 8 8  
1,75€

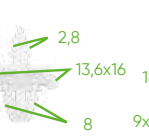

**14441** 10 10  
1,65€  
OE 0019884981

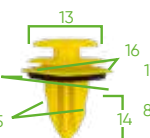

**14442** 6 6  
1,45€

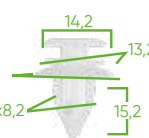

**14443** 8 8  
1,45€

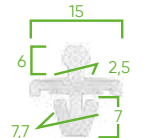

**14444** 10 10  
1,90€  
OE 0019886081

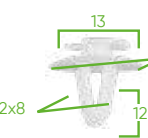

**14445** 10 10  
1,45€

0,17 6 24 216  
Kg

## PARA VAG / SEAT / SKODA PARA PUERTA / MOLDURA / TAPICERÍA

**53716**  
19,00€

**79**  
PCS

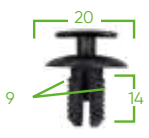

**14422** 6 6  
1,50€  
OE A0009913940

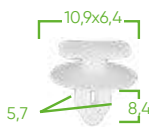

**14423** 15 15  
3,55€  
OE 6E0837732



**14424** 7 7  
1,85€



**14425** 2 2  
2,05€  
OE 6Q0868243



**14426** 8 8  
1,90€  
OE 171201969

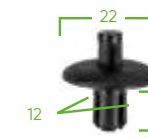

**14427** 8 4  
1,20€  
OE 4D0807300

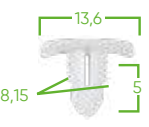

**14428** 12 12  
1,40€  
OE 251823717



**14429** 6 6  
1,80€



**14430** 3 3  
2,25€  
OE 8E0821989A



**14431** 2 2  
1,45€  
OE 3B0868243



**14432** 10 10  
1,45€  
OE 1H0823717

0,15 6 24 216  
Kg



# ESTUCHES DE CLIPS PLÁSTICOS

## PARA PEUGEOT / CITROËN PARA TAPICERÍA

53715

19,00€

110  
PCS



0,15 6 24 216



14410 10 10  
1,85€

14411 10 5  
1,70€

14412 10 10  
1,70€

14413 10 10  
3,25€

14414 10 10  
1,70€

OE 2346824



14415 10 10  
1,70€

14416 10 5  
1,25€

14419 15 15  
1,95€

14420 15 15  
1,50€

14421 10 10  
2,45€

OE A1249900492

OE 6992C6

OE 14093311

## PARA PEUGEOT / CITROËN PARA PANEL DE PUERTA

53713

16,00€

93  
PCS



0,16 6 24 216



14350 6 6  
1,80€

14358 10 10  
1,70€

14387 8 8  
1,45€

14388 8 8  
2,05€

14389 6 6  
1,25€

14390 6 6  
1,35€

OE 6991Y8

PEUGEOT: 6991Y8  
CITROËN: 6991Y8  
FIAT: 9654280780  
RENAULT: 7703077469

OE 7703077250

OE 6995A3

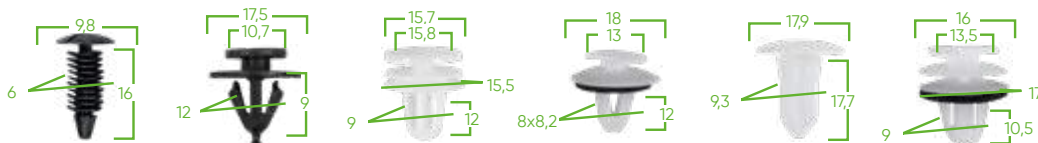

14391 15 15  
2,15€

14392 6 6  
1,35€

14393 8 8  
1,50€

14395 8 8  
1,65€

14396 6 6  
1,20€

14397 6 6  
1,45€

## PARA PEUGEOT / CITROËN PARA MOLDURA

53714

16,00€

80  
PCS



0,14 6 24 216



14398 8 8  
1,30€

14399 6 6  
1,90€

14402 8 8  
1,50€

OE 6995X3

OE 129943

OE 856548



14404 8 8  
2,10€

14405 16 8  
1,45€

14406 10 10  
1,55€

OE 71728806

OE 968865987703

OE 856540



14408 10 10  
1,45€

14409 8 8  
1,35€

OE 856534

OE 357853586

## ALICATE PARA EXTRACCIÓN DE GRAPAS DE CARROCERÍA

53385

18,00€

0,15 6 54 499



CORTAR

EXTRAER

BRIDAR



- Punta en ángulo:  
Diseñado para extraer/cortar grapas/  
clips fácilmente y sin daño.  
Permite un fácil acceso a áreas con-  
finadas.

## PARA RENAULT / DACIA PARA TAPICERÍA

**53712**  
16,00€

**109**  
PCS



0,17 6 24 216  
Kg

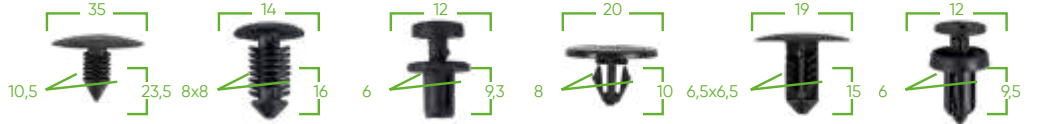

**14374** 3 3  
1,70€  
OE 7703077435

**14375** 15 15  
1,85€

**14376** 20 20  
2,60€  
OE 7L6868307

**14377** 10 10  
1,90€

**14378** 12 12  
1,90€

**14379** 6 6  
1,45€  
OE 7703077117



**14381** 10 10  
1,70€



**14383** 6 6  
1,35€  
OE 7703072360

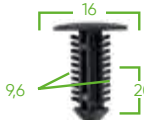

**14382** 10 10  
1,85€  
OE 7703077153

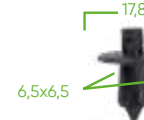

**14384** 12 12  
2,10€  
OE W705956S300



**14416** 5 5  
1,25€  
OE 6992C6

## PARA RENAULT / DACIA PARA MÓLDURA

**53711**  
16,00€

**90**  
PCS



0,19 6 24 216  
Kg



**14358** 10 10  
1,70€



**14364** 10 10  
1,90€



**14365** 10 10  
1,90€



**14356** 12 10  
1,90€



**14367** 3 3  
1,30€

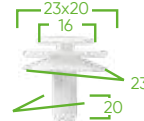

**14368** 8 8  
1,45€  
OE 7L5853994



**14370** 3 3  
3,00€



**14371** 3 3  
3,00€

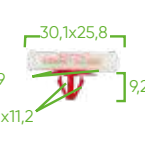

**14366** 8 8  
1,45€

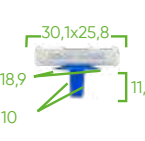

**14372** 4 4  
1,20€



**14369** 15 15  
4,95€  
OE 7701061797

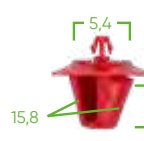

**14373** 4 4  
1,35€

PEUGEOT: 6991Y8  
CITROËN: 6991Y8  
FIAT: 9654280780  
RENAULT: 703077469  
OPEL: 7701470779  
NISSAN: 7703077421  
RENAULT: 7703077421  
IVECO: 500326896  
OPEL: 7701470779  
NISSAN: 7703077421  
RENAULT: 7703077421  
IVECO: 500326896  
RENAULT: 7703077368  
OPEL: 4430858

## PARA RENAULT / DACIA PARA PANEL DE PUERTA

**53710**  
16,00€

**85**  
PCS



0,18 6 24 216  
Kg



**14350** 12 6  
1,80€  
OE 6991Y8

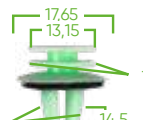

**14351** 8 8  
1,65€



**14352** 7 7  
1,30€  
OE 51447780135



**14353** 4 4  
2,10€  
OE 7703077476



**14355** 8 8  
1,70€  
OE 7703077354



**14356** 10 10  
1,90€  
OPEL: 4430858  
RENAULT: 7703077368



**14357** 10 10  
1,90€  
OE 7703077430



**14359** 4 4  
1,05€  
OE 51418224768

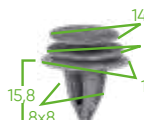

**14361** 8 8  
1,70€



**14358** 10 10  
1,70€

PEUGEOT: 6991Y8  
CITROËN: 6991Y8  
FIAT: 9654280780  
RENAULT: 7703077469

## PÓSTER CLIPS

**15001**  
3,00€

- Conjunto de 2 pósters informativos de los clips plásticos JBM. Con toda la información de cada clip (referencia, precio, medidas).



330x1000mm



CHALECOS

340



CHAQUETAS

340



# ROPA LABORAL



**SERIE182**

## CHALECOS JBM

TALLA M

**70001**  
35,00€



TALLA L

**70002**  
37,50€



TALLA XL

**70003**  
37,50€



**70007**  
35,00€



**70008**  
37,50€



**70009**  
37,50€



2 BOLSILLOS INTERIORES  
DE GRAN CAPACIDAD



2 BOLSILLOS  
LATERALES



Resistente  
al frío

Térmica

Ligera

## CHAQUETAS JBM

TALLA M

**70004**  
42,00€



TALLA L

**70005**  
42,00€



TALLA XL

**70006**  
42,00€



**70010**  
42,00€



**70011**  
42,00€



**70012**  
42,00€



CUELLO ELEVADO ALTO  
Y CON CREMALLERA  
DELANTE



3 BOLSILLOS  
EXTERIORES



Resistente  
al frío

Térmica

Ligera

PERCHA

**13929**  
3,60€

0,05 20



490mm



EXPOSITOR JBM

**METEXP**  
57,00€

6 1 16





DISPOSITIVOS ELECTRÓNICOS

342



PROMOCIONALES

342



EXPOSITORES Y ACCESORIOS

347



PACKAGING

349



# PROMOCIONALES



# CÁMARA DEPORTIVA

53865

0,30 36 432

48,00€

Kg fl



GRABACIÓN DE ALTA DEFINICIÓN

- ✓ Una carcasa resistente al agua que le permite filmar hasta 30 metros bajo el agua.
- ✓ Pantalla LTPS LCD de alta definición.
- ✓ Batería fácil de desmontar.
- ✓ Grabación de vídeo digital, fotos, visualización de vídeo y grabación de audio.
- ✓ Lente angular HD de 120°.
- ✓ Cámara web.
- ✓ Admite tarjetas de almacenamiento de hasta 64GB.
- ✓ Múltiples formatos de grabación.
- ✓ Detección de movimiento y grabación cíclica.



## DISEÑADO PARA:

- Grabar desde el vehículo
- Seguridad del hogar
- Hacer fotos
- Deportes al aire libre
- Sondeo en aguas profundas
- Etc.



PANTALLA LTPS LCD DE ALTA DEFINICIÓN



## ACCESORIOS:



# SILLA GIRATORIA

53956

18,4

353,00€

Kg fl 1

- ✓ Material: Poliuretano
- ✓ Grosor estructura de acero: 1,2cm
- ✓ Espuma del asiento: Espuma moldeada
- ✓ Espuma del respaldo: Espuma primaria
- ✓ Apoyabrazos: 2D
- ✓ Piston elevador de gas: Clase 3
- ✓ Base de nylon: 350mm

COJÍN REPOSACABEZAS

MEDIDAS 70X55X126-136CM

200Kg



COJÍN LUMBAR

ALTIMA REGULABLE

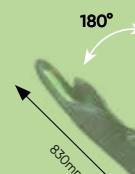

### PATAS CON RUEDAS

15256 1,90 10 36,00€

### REPOSABRAZOS DERECHO

15257 1,34 10 27,50€

### REPOSABRAZOS IZQUIERDO

15258 1,34 10 27,50€

### AMORTIGUADOR

15259 0,78 5 18,00€

### SET DE 5 RUEDAS

15260 0,59 10 22,50€



# CARPA STAND JBM 3x3m

**53973**

284,00€

18,40	1	31

INCLUYE FUNDA PARA CARPA:

**14347**

36,50€

0,60	5

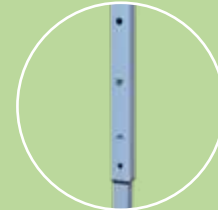
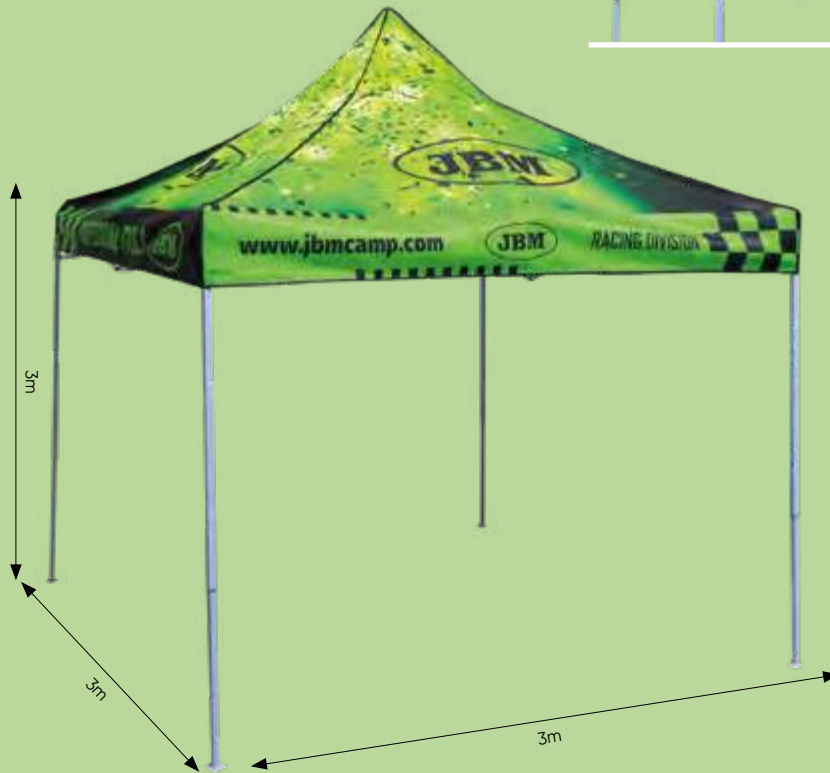

ALTURA REGULABLE



ANCLAJE EN EL SUELO



## LATERAL PARA REF. 53973

**15152**

142,50€

0,50	5

Consta de dos partes:

- Parte lateral que cubre 3/4 partes de la carpa.
- Parte delantera que cubre 1/4 parte de la carpa. Con cremallera vertical a modo de puerta.



## MOCHILA JBM

54043

42,50€

1,1	5	15

✓ **Espacio de almacenamiento:**  
Con un total de dos compartimentos tiene capacidad para ordenadores portátiles de menos de 17,3 pulgadas y tablets, entre otros.

✓ **Material:**  
Poliuretano, es una mochila impermeable, sólida y resistente

✓ **Ligera y cómoda**  
Diseño de malla de esponja cómoda y transpirable de la espalda y las correas.



## TAZA JBM

54076

8,00€

0,3	1

340ml

Ø 80mm

95mm



## FARO PORTÁTIL LED CON LINTERNA / ALTAVOZ / CARGADOR

53199

24,00€

0,4	18	306

1- LINTERNA  
2- CARGADOR  
3- ALTAVOZ



## CAMISETA POLO JBM

REF.	TALLA				€
13243	M	0,25	100	600	12,50€
13244	L	0,26	100	600	12,50€
13245	XL	0,28	100	600	12,50€



## BOLÍGRAFO DE 4 COLORES PUBLICITARIO JBM

53533

1,00€

0,01	50	1.000

- Bolígrafo de 4 colores: azul, rojo, negro, verde.



CON PUNTERO TRASERO DE GOMA PARA ESCRIBIR EN PANTALLAS TÁCTILES



## BOLSA JBM

13968

3,00€

	0,01
	50
	200
	3.200





## PATINETE ELÉCTRICO 36V 350W BRUSHLESS

53920

12 1  
Kg fl

537,00€



- Dimensiones desplegado: 109x42x109cm
- Tamaño de la cubierta: 67x14cm
- Altura del manillar: 109cm
- Alcance máximo: hasta 26 km
- Ángulo de ascenso: hasta 15°
- Límite de peso: hasta 107kg

Gestiona todas las **características técnicas** desde tu móvil:

- Indicador de nivel de batería.
- Cambia el modo límite de velocidad.
- Cambia el modo de arranque.
- Controla la velocidad a la que circulas.
- Enciende/apaga la luz LED.
- Bloquea el patinete para que no pueda ser usado o robado (bloqueo de motor).



PANTALLA LCD

15+

1.090mm

1.090mm

420mm



DIMENSIONES PLEGADO  
1.090x420x460mm

## BICICLETA ESTÁTICA

53930

25,5 1  
Kg fl

276,00€

- Tiempo: 0:00~99:59 min
- Distancia: 0.00~9999 ml (km)
- Distancia total: 0.00~9999 ml (km)
- Velocidad: 0.0~9999
- Calorías: 0.0~9999 kcal
- Pulso: 40~240 bpm
- Batería: tamaño-AAA \*2
- Temperatura de funcionamiento: 0 ~ 40°C (32-104°F)
- Temperatura de almacenaje: 10 ~ 60°C (14-168°F)

FUNCIONES DE LA COMPUTADORA:

- TIEMPO
- VELOCIDAD
- DISTANCIA
- CALORIAS
- ODÓMETRO
- PULSO
- ESCANEO



SILLÍN DE GRAN COMODIDAD



AJUSTE DE FUERZA



CON RUEDAS PARA FACILITAR SU TRANSPORTE



BUEN AGARRE

## PATINETE DE 2 RUEDAS SCOOTER

53504

3,5 6 36  
Kg fl

48,00€

77mm 100mm



REGULABLE



## CINTA DE CORRER

53934

37 1  
Kg fl

602,00€

1160mm 1450mm 675mm

110 KG

- Tensión de entrada: 220V - 240V
- Frecuencia de entrada: 50 - 60 Hz
- Potencia nominal: 550W
- Potencia máxima: 1500W (2.0HP)
- Velocidad: niveles 1.0 - 12 (velocidad máxima 9.5 km/h)
- Tamaño de plegado: 970x675x1275 mm
- Longitud de la cinta: 400x1100 mm
- Función: Corriendo, Massaje, Sit-up
- Pantalla: 3.5" LED

FUNCIONES DE LA PANTALLA:

- TIEMPO
- DISTANCIA
- VELOCIDAD
- CALORIAS
- PULSO

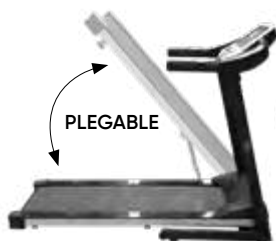

PLEGABLE



400mm

1100mm

## BARBARCOA CON PARRILLA

53931

104,00€



- Material: hierro y alambre.
- Grosor: 0.4mm.
- Acabado: tapa con recubrimiento de polvo negro y bol de porcelana en negro.
- Parrilla de cocina: 43x40cm, cromada.
- Parrilla de carbón: 36x36cm, zincada.
- Altura de cocción: 59 cm.
- Patas: de acero inoxidable 430, 19mm de diámetro.

ESCAPE DE AIRE EN LA TAPA



TAPA CON RECUBRIMIENTO DE POLVO NEGRO Y BOL DE PORCELANA EN NEGRO

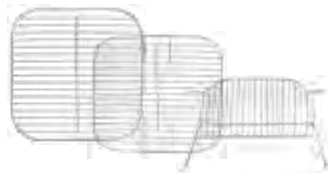

UNA PARRILLA DE COCINA, UNA PARRILLA DE CARBÓN Y UNA PARRILLA PARA CALENTAR

PATAS DE ACERO INOXIDABLE



CON UN ESTANTE LATERAL, 2 RUEDAS, UN ASA Y UN BOL

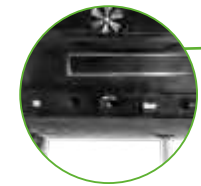

## JAMONERO

14975

64,00€



- Dimensiones: 500x330x440mm
- Peso: 2,18kg



## SET DE 3 CUCHILLOS

53511

23,00€



3 PCS

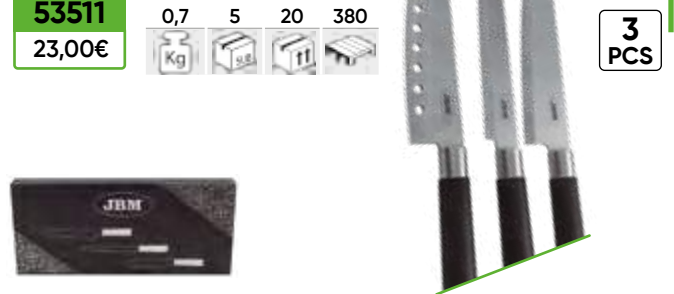

## BOLSA NEVERA JBM

53949

4,50€



53950

4,50€



350mm  
675mm  
675mm



## CUBERTERÍA

53512

41,00€



24 PCS



## PARAGUAS PROMOCIONAL JBM

52857

7,50€



84mm

## COLLAR PERLA

53513

9,00€



## SET DE 2 TOALLAS

53510

24,00€



2 PCS





## EXPOSITOR DE HERRAMIENTAS VACÍO

53877

37,7

1

430,50€

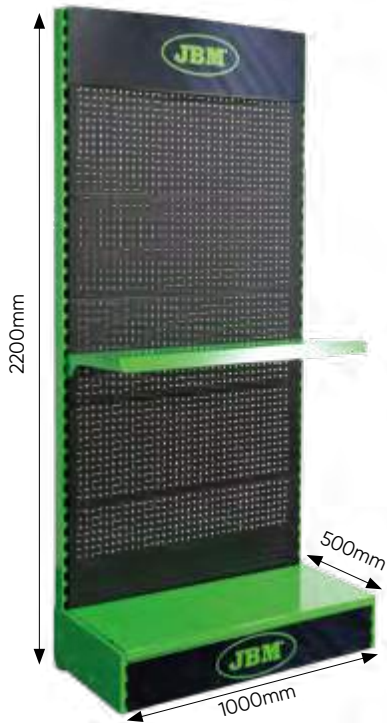

CONTIENE

14945 x1



11318 x1



14380 x20



14946 x1



## DESPIECE EXPOSITORES

14946

2,7

1

58,00€

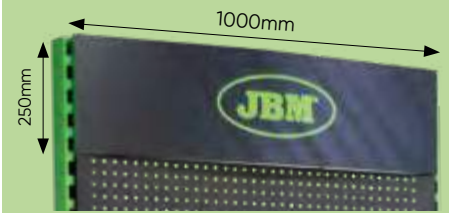

14947

6,3

1

201,50€

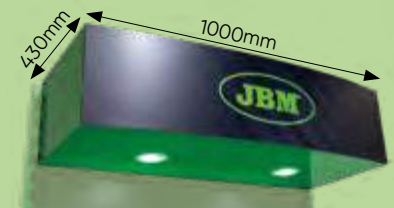

14380

5

1

27

51,00€



2 posiciones

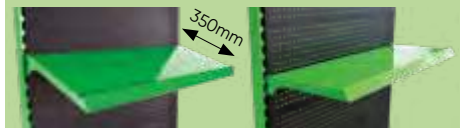

14996

5,8

1

64,50€

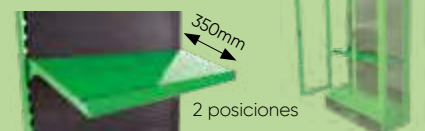

14948

251,50€

21,5

1



14945

303,50€

21,5

1

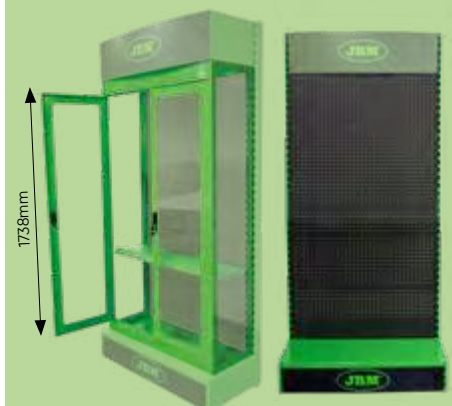

## EXPOSITOR DE HERRAMIENTAS + CABEZAL CON ILUMINACIÓN

53878

41,3

1

574,00€



## EXPOSITOR + CABEZAL CON ILUMINACIÓN Y PUERTAS

53879

62,8

1

838,50€



CONTIENE

14945 x1



14380 x1



14947 x1



11318 x20



CONTIENE

14945 x1



14948 x1



14996 x1



14947 x1



## BANDEJA SOPORTE

14622

0,9 10  
Kg ft

PARA REF. 60001, 60003, 60004, 60020

17,00€

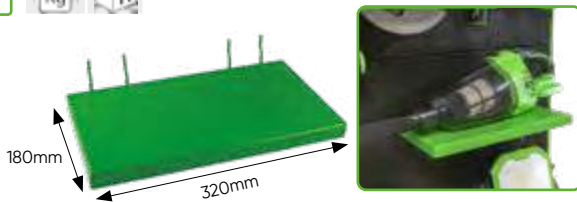

14624

0,6 10  
Kg ft

PARA REF. 60007, 60010, 60011

17,00€

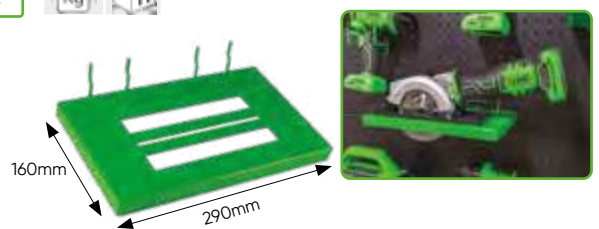

## GANCHOS

14626

0,1 10  
Kg ft

PARA REF. 60023

7,00€

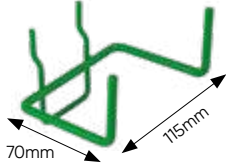

14623

0,1 10  
Kg ft

PARA REF. 60005, 60006, 60018

8,00€

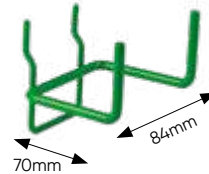

## GANCHOS

DE PUNTA

11318

0,04 20 600  
Kg us ft

2,50€



DE PUNTA CERRADA

51315

0,03 20 320  
Kg us ft

2,50€



## SOPORTE PARA REF. 60008, 60009

14625

14,00€

0,5 10  
Kg ft

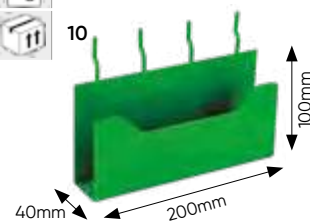

PARA HERRAMIENTA NEUMÁTICA

14034

0,2 20 80 1.920  
Kg us ft

9,00€

106mm



## EXPOSITOR DE HERRAMIENTA NEUMÁTICA

53492

379,50€

13 1 7  
Kg ft

HERRAMIENTAS NO INCLUIDAS



## EXPOSITOR DE ALFOMBRAS JBM

METEXP

57,00€

6 1 16  
Kg ft





## CAJAS PARA DESPIECE HERRAMIENTA MANUAL

REF.	cm				€
14922	14,5x9x10	0,10	100		1,65€
14923	17,5x9x7	0,10	100		1,65€
14924	24x11x7	0,10	100		1,65€
14925	31,5x13x4	0,10	100		1,65€
14926	32x8,5x7	0,10	100		1,90€



## PRECINTO DE GARANTÍA JBM

14807

11,00€

0,45	6	24	864

- 75mm ancho x 125m largo
- Fabricado en Polipropileno
- Adhesivo solvente
- Grosor: 28 micras



MULTI IDIOMA

## CAJA CARTÓN LOTE PROMOCIONAL NAVIDAD

REF.	cm				€
14976	80x31x60	2,20	1	80	27,50€
15056	40x30x61	1,60	1	70	17,00€
13717	76x14x29	0,90	1	200	11,50€
14083	80x28x49	1,80	1	90	19,50€



14976



15056



## CAJAS DE CARTÓN JBM



12950



14189

14507











15064

REF.	cm				€
11330	19x10x11	0,05	50	4.200	1,00€
12952	40x30x20	0,40	30	360	2,50€
15051	40x32x30	0,40	20	160	3,00€
14974	54x40x24	0,65	20	150	3,50€
13217	57x30x25	0,55	15	150	3,50€
12950	60x40x30	1	15	75	3,50€

REF.	DESCRIPCIÓN				€
14189	Pallet box americano triple canal 120x80x100cm	10	1	40	28,50€
14507	Pallet box europeo 120x98x80cm	8	1	40	52,50€

# LEYENDA

























## Leyenda datos referencias

	Peso del artículo en kilogramos
	Cantidad de artículos por subcaja
	Cantidad de artículos por expositor
	Cantidad de artículos por bolsa
	Cantidad de artículos por caja
	Cantidad de bolsas por caja
	Cantidad de artículos por palet
	Presentado en blister
	Producto nuevo

## Leyenda características generales

	Capacidad por volumen
	Imantado
	Peso que soporta el imán
	Peso que soporta el artículo
	Nivel de ruido (decibelios)
	Peso
	Peso ligero
	Zoom
	Conexión bluetooth
	Conexión USB
	Material de Aluminio
	Acabado cromado

## Leyenda herramientas

	Vaso cuadrado
	Vaso de 12 cantos
	Vaso de 12 cantos (2)
	Vaso hexagonal
	Vaso punta XZN
	Vaso twist
	Vaso spline
	Punta Slotted
	Punta ribe
	Punta Phillips (estrella)
	Punta Pozidriv (doble estrella)
	Cuatri punta
	Punta torx inviolable
	Punta torx inviolable - XZN
	Punta torx
	Tri punta
	Punta TS 5 caras
	Punta de 12 cantos
	Punta tensor
	Allen
	Punta mariposa
	Punta allen
	Punta allen inviolable
	Cabota normal
	Cabota redonda



## Leyenda productos neumáticos



	Revoluciones por minuto (general)
	Revoluciones por minuto (adelante)
	Revoluciones por minuto (inversa)
	Newton-metro(Nm) / Kilogramos(Kg)
	Libra por pulgada cuadrada
	Unidad de presión (Bar)
	Entrada de aire
	Salida trasera
	Salida trasera de 360°
	Salida delantera
	Salida delantera
	Salida delantera
	Medidas
	Mango ergonómico
	Órbita del disco
	Diámetro de disco
	Tamaño broca
	Medida entrada taladro
	Movimientos en 360°
	N° de velocidades
	Caballos de fuerza
	Mecanismo doble martillo
	Ángulo de 90°





# LEYENDA

## Leyenda productos electrónicos



-  Tipo de Led: SMD
-  Tipo de Led: COB
-  Tipo de Led: Cree XP-E
-  Cantidad / potencia Leds
-  Cantidad de Leds
-  Distancia de iluminación
-  3 intensidades de luz
-  Flujo luminoso (Lumen)
-  Luz dispersa
-  Luz concentrada
-  Cantidad de tipos de flash
-  Potencia Volts/Watts
-  Duración de la batería
-  Duración de carga
-  Tipo de batería
-  Cantidad de pilas AAA
-  Transformador / toma de pared
-  Cargador con USB
-  Toma de mechero
-  Base reclinable
-  Base reclinable
-  Colgador
-  Colgador giratorio
-  Largo de cable

-  Resistente a los golpes
-  Grado de protección IP
-  Imantado



## Leyenda productos utillaje

-  Compresor de muelles
-  Desmontaje de amortiguadores



## Leyenda productos lubricantes

-  Capacidad de embudo
-  Caudal

## Leyenda accesorios

-  Alcanza los 1.300°
-  Dos tipos de llamarada

## Leyenda certificados

-  Certificado CE
-  Normativa conforme a los guantes de protección
-  Cumplimiento de la Ley de Seguridad de Productos Alemán (ProdSG)



# ÍNDICE NUMÉRICO

REF.	pág.	PVP	REF.	pág.	PVP	REF.	pág.	PVP	REF.	pág.	PVP
10000	248		10566	39		10639	257		10813	320	
10054	194		10567	39		10642	60		10823	323	
10055	194		10568	39		10643	60		10824	323	
10485	195		10569	39		10644	60		10825	323	
10486	195		10570	39		10671	266		10826	323	
10494	195		10571	39		10672	207		10827	323	
10495	195		10579	40		10673	207		10828	323	
10496	195		10580	40		10674	207		10829	323	
10497	195		10581	40		10675	207		10830	323	
10498	195		10582	40		10720	275		10831	323	
10499	195		10583	40		10721	275		10832	323	
10500	195		10584	40		10722	275		10833	323	
10501	195		10585	40		10723	275		10834	323	
10502	195		10586	40		10724	275		10835	323	
10526	60		10587	40		10727	79		10836	323	
10527	38		10588	40		10731	79		10837	323	
10528	38		10589	40		10732	79		10838	323	
10529	38		10590	40		10733	79		10839	323	
10530	38		10591	42		10735	79		10840	323	
10531	39		10592	42		10750	124		10868	327	
10532	39		10593	42		10751	124		10869	327	
10533	39		10594	42		10761	275		10870	327	
10534	39		10595	42		10762	275		10871	327	
10535	39		10596	42		10766	124/130		10872	327	
10536	39		10597	42		10767	248		10873	327	
10537	39		10598	42		10768	257		10874	327	
10538	39		10599	42		10769	257		10875	327	
10539	39		10600	42		10770	257		10876	327	
10540	39		10601	42		10772	322		10877	321	
10541	39		10602	42		10773	322		10878	321	
10542	39		10603	42		10774	322		10879	321	
10543	39		10604	42		10775	322		10880	321	
10544	39		10617	38		10776	322		10881	321	
10545	39		10618	38		10777	322		10882	319	
10546	39		10619	38		10778	322		10883	319	
10547	39		10620	38		10779	320/322		10884	319	
10548	39		10621	38		10780	320/322		10885	329	
10549	39		10622	38		10781	320/322		10886	329	
10550	39		10623	38		10782	322		10887	329	
10551	39		10624	38		10783	322		10888	329	
10552	36		10625	38		10784	320/322		10889	329	
10553	36		10626	38		10785	320/322		10890	329	
10554	36		10627	40		10786	320/322		10891	329	
10555	36		10628	40		10787	322		10892	329	
10556	36		10629	40		10788	322		10893	329	
10557	36		10630	40		10789	322		10894	329	
10558	36		10631	40		10790	322		10895	329	
10559	36		10632	40		10791	322		10896	329	
10560	36		10633	40		10792	322		10897	329	
10561	36		10634	40		10793	319		10898	329	
10562	36		10635	40		10794	319		10899	329	
10563	36		10636	40		10795	319		10900	329	
10564	39		10637	40		10805	320		10901	329	
10565	39		10638	40		10812	320		10902	329	



REF.	pág.	PVP
10905	329	
10906	329	
10907	329	
10908	329	
10909	329	
10910	329	
10911	329	
10912	329	
10913	329	
10914	329	
10915	328/329	
10916	329	
10917	328/329	
10918	328/329	
10919	328/329	
10920	328/329	
10921	328/329	
10923	119	
10925	248	
10945	290	
10953	197	
10955	182	
10961	120	
10964	176/288	
10965	176/288	
10966	176/288	
10993	265	
11093	120	
11095	275	
11098	275	
11100	275	
11101	275	
11102	275	
11103	124	
11106	184	
11107	120	
11121	152/157	
11122	152/157	
11123	152/157	
11124	157	
11125	157	
11126	157	
11127	157	
11128	157	
11129	157	
11130	157	
11131	157	
11132	157	
11133	157	
11134	157	
11135	157	
11136	157	
11137	157	
11138	157	
11139	157	
11140	157	

REF.	pág.	PVP
11141	157	
11142	157	
11143	157	
11144	157	
11145	157	
11146	157	
11147	157	
11148	157	
11149	157	
11150	157	
11151	157	
11152	157	
11153	156/157	
11154	157	
11155	156/157	
11156	157	
11157	157	
11158	156/157	
11159	157	
11160	157	
11161	157	
11162	157	
11163	157	
11164	157	
11165	157	
11166	157	
11167	157	
11168	157	
11169	157	
11170	157	
11171	157	
11172	157	
11173	157	
11174	157	
11175	157	
11176	157	
11177	157	
11178	157	
11179	157	
11180	157	
11181	157	
11182	157	
11183	157	
11184	157	
11185	157	
11186	157	
11187	157	
11188	157	
11189	157	
11190	157	
11191	157	
11192	157	
11193	157	
11194	157	
11195	152/157	
11212	48	

REF.	pág.	PVP
11213	48	
11214	48	
11219	272	
11244	42	
11245	42	
11246	42	
11247	42	
11248	42	
11249	42	
11250	41	
11251	41	
11252	41	
11253	41	
11254	41	
11255	41	
11256	41	
11257	41	
11258	41	
11259	41	
11260	41	
11261	41	
11262	41	
11313	80	
11314	153	
11315	153	
11316	153	
11318	348	
11323	263	
11324	125	
11325	125	
11329	272	
11330	349	
11360	29	
11361	29	
11362	29	
11363	29	
11364	29	
11365	29	
11374	182	
11375	182	
11376	182	
11377	182	
11378	182	
11379	182	
11380	182	
11381	182	
11382	182	
11383	182	
11384	182	
11385	182	
11386	182	
11387	182	
11388	182	
11389	182	
11390	182	
11391	182	

REF.	pág.	PVP
11392	182	
11393	182	
11394	182	
11492	199	
11493	199	
11494	199	
11541	163	
11542	163	
11543	163	
11544	163	
11545	163	
11546	163	
11547	163	
11613	157	
11614	157	
11615	157	
11616	157	
11617	157	
11618	157	
11619	157	
11621	157	
11622	157	
11623	157	
11624	157	
11625	157	
11628	153	
11639	41	
11640	41	
11641	41	
11642	41	
11643	41	
11644	41	
11645	41	
11646	41	
11867	252	
11878	216	
11879	216	
11880	216	
11890	306	
11891	306	
11892	266	
11893	192	
11894	192	
11895	192	
11896	192	
11897	176/287	
11900	302	
11901	302	
11902	302	
11903	302	
11904	302	
11905	302	
11906	302	
11907	302	
11936	184	
11937	184	

REF.	pág.	PVP
11938	154	
11939	257	
11945	56	
11946	56	
11947	56	
11950	265	
11956	139	
11957	139	
11959	171	
11960	293/302	
11962	152/156	
11963	156	
11964	156	
11965	156	
11966	156	
11967	156	
11974	274	
11975	274	
11976	274	
11977	274	
11978	274	
11979	274	
11980	274	
11981	274	
11982	274	
11983	274	
11989	120	
11990	152/154	
11992	272	
11994	78	
11996	78	
11997	78	
11998	78	
12009	141	
12022	171/266	
12029	32	
12030	32	
12032	263	
12044	251	
12046	260	
12055	288	
12056	248	
12060	49	
12061	152/153/157	
12062	152/153/157	
12063	152/153/157	
12064	152/157	
12065	152/153/157	
12066	152/153/157	
12067	152/157	
12068	152/153/157	
12069	152/153/157	
12070	152/153/157	
12071	152/153/157	
12072	152/157	
12074	152/154	

REF.	pág.	PVP
12075	152/154	
12200	210	
12889	266	
12901	188	
12902	301	
12908	301	
12910	301	
12915	301	
12920	301	
12923	301	
12924	301	
12925	301	
12926	202	
12927	202	
12928	202	
12929	202	
12930	202	
12937	152/154	
12938	155	
12939	155	
12940	155	
12941	155	
12942	155	
12943	155	
12944	155	
12945	155	
12950	349	
12952	349	
12954	329	
12955	162	
12956	162	
12957	162	
12958	162	
12959	162	
12960	162	
12961	162	
12964	58	
12965	58	
12973	302	
12974	179	
12975	179	
12977	210	
12984	157	
12987	144	
12988	150	
12995	56	
12996	56	
12997	56	
12998	56	
12999	56	
13002	330	
13003	330	
13004	330	
13005	330	
13006	330	
13007	330	

REF.	pág.	PVP
13008	330	
13009	330	
13010	330	
13011	330	
13012	330	
13013	330	
13014	330	
13015	330	
13016	330	
13017	330	
13018	330	
13019	330	
13020	330	
13021	330	
13022	330	
13023	330	
13024	330	
13025	330	
13026	335	
13027	335	
13028	335	
13029	335	
13030	335	
13031	335	
13032	335	
13033	335	
13034	335	
13035	335	
13036	335	
13037	335	
13038	332	
13039	332	
13040	332	
13041	332	
13042	332	
13043	332	
13044	332	
13045	332	
13046	332	
13047	332	
13048	332	
13049	332	
13050	333	
13051	333	
13052	333	
13053	333	
13054	333	
13055	333	
13056	333	
13057	333	
13058	333	
13059	333	
13060	333	
13061	333	
13062	333	
13063	333	

REF.	pág.	PVP
13064	333	
13065	333	
13066	333	
13067	333	
13068	332	
13069	332	
13070	332	
13071	332	
13072	332	
13073	332	
13074	333	
13075	333	
13076	333	
13077	333	
13078	333	
13079	333	
13080	332	
13081	332	
13082	332	
13083	332	
13084	332	
13085	332	
13086	332	
13087	332	
13088	332	
13089	332	
13090	332	
13091	332	
13092	334	
13093	334	
13094	334	
13095	334	
13096	334	
13097	334	
13098	334	
13099	334	
13100	334	
13101	334	
13102	334	
13103	334	
13104	330	
13105	330	
13106	330	
13107	330	
13108	330	
13109	330	
13110	330	
13111	330	
13112	330	
13113	330	
13114	330	
13115	330	
13116	334	
13117	334	
13118	334	
13119	334	



REF.	pág.	PVP
13120	334	
13121	334	
13122	334	
13123	334	
13124	334	
13125	334	
13126	334	
13127	334	
13128	331	
13129	331	
13130	331	
13131	331	
13132	331	
13133	331	
13134	331	
13135	331	
13136	331	
13137	331	
13138	331	
13139	331	
13140	331	
13141	331	
13142	331	
13143	331	
13144	331	
13145	331	
13146	331	
13147	331	
13148	331	
13149	331	
13150	331	
13151	331	
13152	331	
13153	331	
13154	331	
13155	331	
13156	331	
13157	331	
13158	331	
13159	331	
13160	331	
13161	331	
13162	331	
13163	331	
13217	349	
13226	51	
13227	51	
13228	51	
13229	51	
13230	51	
13231	51	
13232	51	
13234	251	
13235	321	
13236	321	
13237	321	

REF.	pág.	PVP
13238	321	
13239	321	
13240	321	
13241	321	
13243	344	
13244	344	
13245	344	
13447	38	
13448	38	
13449	38	
13450	38	
13451	38	
13452	38	
13453	36	
13454	36	
13455	36	
13456	36	
13457	36	
13460	36	
13462	36	
13463	37	
13464	37	
13465	37	
13466	37	
13467	37	
13468	37	
13469	37	
13470	37	
13471	37	
13472	37	
13473	37	
13474	37	
13475	37	
13476	37	
13477	37	
13478	37	
13479	37	
13480	37	
13481	37	
13482	37	
13483	37	
13484	37	
13485	36	
13486	36	
13487	36	
13488	36	
13489	36	
13490	36	
13491	36	
13492	36	
13493	36	
13494	36	
13495	36	
13496	36	
13497	36	
13498	36	

REF.	pág.	PVP
13499	141	
13500	141	
13667	51/78	
13668	47/78	
13669	59/78	
13672	263	
13674	52/321	
13675	52/321	
13676	52/321	
13677	52/321	
13678	52/321	
13679	199	
13680	154	
13681	154	
13682	154	
13683	154	
13684	154	
13685	154	
13686	154	
13687	154	
13688	154	
13689	154	
13704	206	
13707	63	
13708	63	
13709	63	
13710	63	
13712	63	
13717	349	
13723	157	
13724	157	
13725	157	
13726	157	
13727	157	
13728	157	
13729	157	
13730	157	
13731	157	
13732	157	
13733	157	
13734	157	
13735	157	
13736	157	
13738	306	
13739	306	
13740	306	
13741	305	
13745	157	
13746	157	
13747	157	
13748	157	
13805	302	
13806	302	
13809	150	
13810	150	
13813	165	

REF.	pág.	PVP
13814	165	
13815	120/293	
13817	139	
13818	139	
13819	323	
13820	323	
13821	323	
13822	323	
13823	323	
13824	323	
13825	323	
13826	323	
13827	323	
13828	323	
13829	323	
13830	323	
13831	323	
13832	323	
13833	323	
13836	256	
13839	120/280	
13842	162	
13843	162	
13844	162	
13845	162	
13853	256	
13856	184	
13859	156	
13870	261	
13874	156	
13875	156	
13876	156	
13877	156	
13879	305	
13880	306	
13884	78	
13892	260	
13923	78	
13929	340	
13930	150	
13931	150	
13932	150	
13933	150	
13934	150	
13935	150	
13936	150	
13937	150	
13938	150	
13939	150	
13945	324	
13946	324	
13947	324	
13948	324	
13949	324	
13950	324	
13951	324	

REF.	pág.	PVP
13952	324	
13953	324	
13954	324	
13955	324	
13956	324	
13957	324	
13958	324	
13959	324	
13960	324	
13961	324	
13962	324	
13963	324	
13964	324	
13965	324	
13966	324	
13967	324	
13968	344	
13969	185	
13982	245/248	
14004	155	
14005	155	
14006	155	
14007	155	
14008	155	
14009	155	
14010	155	
14011	155	
14013	139	
14014	249	
14015	249	
14016	249	
14026	56	
14027	56	
14028	56	
14029	56	
14030	56	
14031	120	
14032	120	
14033	120	
14034	348	
14049	65	
14050	65	
14051	65	
14052	65	
14059	73	
14060	73	
14061	73	
14062	73	
14063	73	
14064	73	
14068	256	
14069	256	
14070	256	
14071	256	
14072	256	
14073	256	

REF.	pág.	PVP
14075	150	
14076	150	
14077	150	
14078	150	
14081	272	
14083	349	
14090	263	
14103	167	
14104	167	
14105	167	
14106	167	
14107	167	
14108	167	
14109	272	
14110	272	
14114	78	
14118	296	
14120	132	
14121	132	
14122	133	
14123	133	
14124	135	
14125	136	
14126	137	
14127	137	
14128	136	
14129	135	
14130	135	
14131	138	
14132	135	
14133	136	
14134	136	
14135	135	
14136	139	
14137	140	
14141	73	
14142	73/179	
14143	73	
14144	73	
14145	268	
14146	268	
14147	268	
14148	268	
14153	134	
14154	141	
14157	140/212	
14158	140/212	
14159	140/212	
14160	140/212	
14161	140/212	
14162	141	
14163	141	
14164	141	
14165	132	
14167	64	
14168	147	

REF.	pág.	PVP
14169	149	
14172	153	
14173	153	
14177	153	
14178	153	
14179	62	
14180	62	
14182	260	
14183	46	
14187	210	
14188	143	
14189	349	
14190	150	
14191	150	
14192	150	
14193	150	
14195	149	
14196	149	
14197	149	
14198	149	
14199	149	
14200	149	
14201	149	
14202	149	
14203	149	
14204	149	
14205	149	
14206	149	
14207	149	
14208	149	
14209	149	
14211	194	
14212	194	
14213	194	
14214	194	
14286	141	
14287	141	
14288	141	
14289	141	
14291	265	
14296	68-76	
14297	68-76	
14298	68-76	
14299	68-76	
14300	209	
14301	209	
14314	149	
14315	149	
14327	82	
14329	260	
14330	141	
14336	134	
14340	193	
14341	193	
14342	193	
14343	193	

REF.	pág.	PVP
14344	193	
14345	193	
14346	193	
14347	343	
14348	214	
14349	214	
14350	337/338	
14351	338	
14352	338	
14353	338	
14354	79	
14355	338	
14356	338	
14357	338	
14358	337/338	
14359	335/338	
14361	338	
14364	338	
14365	338	
14366	338	
14367	338	
14368	338	
14369	338	
14370	338	
14371	338	
14372	338	
14373	338	
14374	338	
14375	338	
14376	338	
14377	338	
14378	338	
14379	338	
14380	347	
14381	338	
14382	338	
14383	338	
14384	338	
14387	337	
14388	337	
14389	337	
14390	337	
14391	337	
14392	337	
14393	337	
14395	337	
14396	337	
14397	337	
14398	337	
14399	337	
14402	337	
14404	337	
14405	337	
14406	337	
14408	337	
14409	337	



REF.	pág.	PVP
14410	337	
14411	337	
14412	337	
14413	337	
14414	337	
14415	337	
14416	337/338	
14419	337	
14420	337	
14421	337	
14422	336	
14423	336	
14424	336	
14425	336	
14426	336	
14427	336	
14428	336	
14429	336	
14430	336	
14431	336	
14432	336	
14434	336	
14435	336	
14436	336	
14437	336	
14438	336	
14439	336	
14440	336	
14441	336	
14442	336	
14443	336	
14444	336	
14445	336	
14446	336	
14447	335/336	
14448	336	
14449	335/336	
14450	336	
14451	336	
14452	336	
14453	336	
14455	336	
14456	336	
14457	336	
14458	335	
14459	335	
14460	335	
14461	335	
14462	335	
14463	335	
14464	335	
14465	335	
14466	335	
14468	335	
14469	335	
14471	335	

REF.	pág.	PVP
14472	335	
14473	247	
14474	335	
14475	335	
14476	335	
14477	335	
14478	335	
14479	335	
14480	335	
14481	335	
14507	349	
14534	146	
14560	146	
14561	146	
14563	211	
14564	163	
14565	163	
14566	163	
14567	163	
14568	163	
14569	163	
14570	163	
14571	163	
14572	163	
14573	163	
14578	79	
14580	79	
14583	134	
14589	263	
14594	209/325	
14595	209/325	
14596	209/325	
14597	209/325	
14598	209/325	
14599	209/325	
14600	209/325	
14601	209/325	
14602	209/325	
14606	246	
14607	246	
14608	246	
14609	246	
14610	246	
14611	199	
14612	199	
14613	199	
14615	257	
14616	262	
14618	133	
14622	112/348	
14623	112/348	
14624	112/348	
14625	112/348	
14626	112/348	
14628	98	
14629	98	

REF.	pág.	PVP
14630	98	
14631	98	
14632	98	
14633	134	
14634	98	
14635	98	
14636	105	
14637	91	
14638	91	
14639	262	
14640	91	
14641	91	
14642	91	
14643	92	
14644	92	
14645	92	
14646	92	
14647	96	
14648	88/89/90	
14649	96	
14650	96	
14651	96	
14652	94	
14653	94	
14654	94	
14655	94	
14656	94	
14657	94	
14658	94	
14659	94	
14660	94	
14661	94	
14662	94	
14663	94	
14664	95	
14665	95	
14666	95	
14667	95	
14668	95	
14670	95	
14671	96	
14672	96	
14674	96	
14675	88/89/90	
14676	88/89/90	
14677	88/89/90	
14678	88/89/90	
14679	88/89/90	
14680	95	
14681	95	
14682	95	
14683	95	
14684	92	
14685	92	
14686	92	
14687	92	

REF.	pág.	PVP
14691	97	
14692	97	
14693	93	
14694	93	
14695	93	
14696	93	
14697	93	
14698	93	
14699	93	
14700	93	
14701	93	
14702	93	
14703	247	
14706	265	
14708	256	
14709	256	
14710	163	
14711	163	
14712	163	
14713	163	
14714	163	
14715	163	
14723	156	
14724	156	
14725	156	
14726	156	
14727	265	
14728	152/157	
14729	152/157	
14730	152/157	
14731	152/157	
14732	152/157	
14733	152/157	
14734	152/157	
14735	152	
14736	153/157	
14737	153/157	
14738	157	
14739	157	
14740	157	
14741	157	
14742	157	
14743	157	
14744	157	
14745	157	
14746	157	
14747	157	
14748	157	
14749	29/156	
14750	29/156	
14751	29/156	
14752	29/156	
14753	128	
14755	268	
14756	268	
14757	268	

REF.	pág.	PVP
14758	268	
14759	268	
14765	91	
14766	94	
14767	94	
14768	95	
14769	88/89/90	
14770	95	
14771	148/279	
14772	148	
14774	279	
14775	315	
14779	135	
14781	312	
14783	79	
14785	266	
14786	310	
14793	312	
14802	315	
14803	316	
14807	349	
14808	94	
14825	108	
14826	108	
14827	108	
14828	108	
14829	108	
14830	108	
14831	108	
14832	108	
14833	108	
14834	108	
14835	108	
14836	108	
14837	108	
14838	108	
14839	108	
14840	108	
14841	108	
14842	108	
14843	109	
14844	109	
14845	109	
14846	109	
14847	109	
14848	109	
14849	109	
14850	109	
14851	109	
14852	109	
14853	109	
14854	109	
14855	109	
14856	109	
14857	109	
14858	109	

REF.	pág.	PVP
14859	109	
14860	109	
14861	109	
14862	109	
14863	109	
14864	109	
14865	109	
14866	109	
14867	109	
14868	109	
14869	109	
14870	109	
14871	109	
14872	109	
14873	109	
14874	109	
14875	109	
14876	109	
14877	109	
14878	109	
14879	109	
14880	109	
14881	109	
14882	109	
14883	109	
14884	109	
14885	109	
14886	109	
14887	109	
14888	109	
14889	109	
14890	109	
14891	109	
14892	109	
14893	111	
14894	111	
14895	111	
14896	111	
14897	111	
14898	111	
14899	111	
14900	111	
14901	110	
14902	110	
14903	110	
14904	110	
14905	110	
14906	110	
14907	108	
14908	108	
14909	108	
14910	108	
14911	108	
14912	108	
14913	108	
14914	108	

REF.	pág.	PVP
14915	108	
14916	108	
14917	108	
14918	294/312	
14919	294/312	
14920	108	
14922	349	
14923	349	
14924	349	
14925	349	
14926	349	
14929	260	
14930	186	
14931	186	
14932	186	
14933	186	
14934	110	
14935	110	
14936	92	
14937	249	
14938	266	
14939	266	
14940	266	
14945	347	
14946	347	
14947	347	
14948	347	
14950	98	
14951	98	
14952	98	
14953	98	
14954	92	
14955	96	
14956	94	
14957	94	
14958	94	
14959	94	
14960	95	
14961	95	
14962	96	
14963	96	
14964	92	
14965	92	
14966	97	
14967	93	
14968	93	
14969	93	
14970	152	
14971	152	
14972	152	
14973	152	
14974	349	
14975	346	
14976	349	
14978	56	
14979	56	

REF.	pág.	PVP
14980	56	
14981	56	
14982	56	
14985	111	
14986	111	
14987	111	
14988	111	
14989	111	
14990	111	
14991	111	
14992	182	
14993	111	
14994	111	
14995	111	
14996	347	
15001	338	
15006	42	
15010	218	
15011	218	
15012	218	
15014	94/111	
15018	75/249	
15019	79	
15020	42	
15021	79	
15022	79	
15023	79	
15024	79	
15025	79	
15026	79	
15029	79	
15030	79	
15031	79	
15032	79	
15033	79	
15034	79	
15035	79	
15036	79	
15037	79	
15038	79	
15039	79	
15040	79	
15041	79	
15042	79	
15043	262	
15044	262	
15046	262	
15047	262	
15048	262	
15049	105	
15050	79	
15051	349	
15052	210	
15053	210	
15054	210	
15056	349	



REF.	pág.	PVP
15058	79	
15059	312	
15062	312	
15065	79	
15068	79	
15069	79	
15070	74	
15071	74	
15072	74	
15073	74	
15074	74	
15075	74	
15076	74	
15084	75/185	
15085	266	
15093	259	
15094	259	
15095	259	
15096	259	
15098	103	
15099	103	
15100	103	
15101	103	
15102	103	
15103	103	
15104	103	
15105	103	
15106	103	
15107	104	
15108	104	
15109	104	
15110	104	
15111	104	
15112	104	
15113	104	
15114	103	
15115	103	
15116	103	
15117	103	
15118	103	
15119	103	
15120	103	
15121	103	
15122	37/77	
15123	247	
15124	105	
15125	105	
15126	100	
15127	100	
15138	53	
15139	53	
15140	53	
15144	81	
15145	81	
15146	81	
15147	55	

REF.	pág.	PVP
15148	55	
15149	55	
15151	98	
15152	343	
15153	286	
15154	286	
15155	42/77	
15156	40/77	
15157	41/77	
15158	38/77	
15159	41/77	
15160	39/77	
15161	39/77	
15162	34/77	
15182	42	
15183	42	
15184	42	
15185	42	
15186	42	
15187	42	
15188	42	
15189	42	
15190	42	
15191	41	
15192	41	
15193	41	
15194	41	
15195	41	
15196	39	
15197	39	
15198	39	
15199	39	
15200	39	
15201	39	
15206	40	
15207	40	
15208	40	
15209	40	
15210	41	
15211	41	
15212	41	
15213	41	
15214	41	
15215	41	
15216	38	
15217	38	
15218	38	
15219	38	
15220	38	
15221	38	
15222	38	
15223	39	
15224	39	
15225	39	
15226	39	
15227	34	

REF.	pág.	PVP
15228	34	
15229	34	
15230	34	
15231	34	
15232	34	
15233	34	
15234	34	
15237	273	
15238	273	
15239	273	
15240	273	
15241	273	
15242	273	
15243	273	
15244	273	
15245	273	
15246	273	
15247	273	
15248	273	
15249	273	
15250	273	
15251	273	
15253	198/203	
15254	91	
15255	261	
15256	342	
15257	342	
15258	342	
15259	342	
15260	342	
15276	99	
15277	99	
15278	99	
15279	99	
15280	99	
15282	249	
15283	249	
15300	293	
15305	249	
15306	249	
15307	249	
15308	249	
15309	249	
15310	249	
15311	249	
15312	249	
15313	79	
15314	209	
15316	38/77	
15317	293	
15318	249	
15320	99	
15321	99	
15322	99	
15323	99	
15324	99	

REF.	pág.	PVP
15325	99	
15326	99	
15327	99	
15328	37	
15329	37	
15330	37	
15331	37	
15332	37	
15333	37	
15334	37	
15335	37	
15336	37	
15337	37	
15338	37	
15339	37	
15340	106/276	
15341	106/276	
15342	106/276	
15343	106/276	
15344	106/276	
15345	106/276	
15346	106/276	
15349	106/276	
15352	37	
15353	37	
15354	37	
15355	37	
15356	37	
15357	37	
15358	37	
15359	37	
15360	37	
15361	37	
15362	37	
15363	37	
15364	37	
15365	37	
15366	37	
15367	37	
15368	37	
15369	37	
15370	37	
15371	37	
15372	37	
15373	37	
15380	100	
15381	100	
15382	100	
15385	121	
15386	100	
15388	278	
15389	278	
15390	278	
15391	278	
15392	278	
15393	278	

REF.	pág.	PVP
15394	278	
15395	278	
15398	278	
15399	278	
15424	106/277	
15425	106/277	
15426	106/277	
15427	106/277	
15428	106/277	
15429	106/277	
15430	106/277	
15431	106/277	
15432	106/277	
15433	106/277	
15434	106/277	
15435	106/277	
15436	106/277	
15437	106/277	
15438	106/277	
15439	106/277	
15440	100	
15448	282	
15454	60/77	
15460	283	
15471	104	
15472	104	
15473	104	
15474	104	
15475	104	
15476	104	
15477	104	
15478	104	
15481	102	
15482	102	
15483	102	
15484	102	
15485	102	
15486	102	
15487	102	
15488	102	
15489	102	
15490	102	
15491	102	
15492	102	
15493	102	
15494	182	
15495	182	
15496	182	
15497	182	
15498	182	
15499	182	
15500	182	
15501	182	
15502	182	
15503	182	
15504	182	

REF.	pág.	PVP
15505	182	
15506	182	
15507	182	
15508	182	
15509	182	
15510	182	
15511	182	
15514	77	
15515	38	
15516	38	
15517	38	
15526	260	
15527	260	
15528	260	
15530	93	
15531	93	
15532	93	
15533	93	
15534	93	
15535	93	
15536	93	
15537	93	
15538	93	
15539	253	
15542	253	
15550	249	
15551	249	
15552	176/287	
15553	246	
50400	174	
50403	174	
50409	174	
50410	174	
50431	129	
50517	287	
50518	287	
50523	129	
50524	129	
50525	293	
50526	293	
50551	129	
50560	39	
50561	40	
50562	40	
50564	39	
50566	16	
50567	61	
50577	167	
50580	61	
50585	298	
50600	300	
50601	300	
50622	38	
50623	25	
50630	265	
50631	263	

REF.	pág.	PVP
50632	275	
50644	164/295	
50651	326	
50652	326	
50654	292/309	
50656	176/287	
50717	164/295	
50724	206	
50731	253	
50751	250	
50754	38	
50760	300	
50761	300	
50762	300	
50763	300	
50764	300	
50765	300	
50766	300	
50767	300	
50768	300	
50771	300	
50774	300	
50776	300	
50777	300	
50778	300	
50779	300	
50780	300	
50781	300	
50782	300	
50783	300	
50784	300	
50785	300	
50786	300	
50787	218	
50788	218	
50789	218	
50790	218	
50792	190	
50793	190	
50797	252/286	
50807	209/326	
50808	84	
50815	257	
50816	256	
50818	257	
50819	258	
50820	258	
50821	258	
50822	258	
50823	258	
50824	258	
50825	258	
50827	213/263	
50830	260	
50831	263	
50835	261	

REF.	pág.	PVP
50836	264	
50838	264	
50839	266	
50840	264	
50843	84	
50844	84	
50852	250	
50889	40	
50896	39	
50901	164	
50902	45	
50903	165	
50910	128	
50911	265	
50913	176/288	
50915	129	
50916	174	
50917	248	
50918	248	
50923	171/266	
50924	245/248	
50935	248	
50937	206	
50942	270/284	
50957	290	
50958	289	
50959	290/322	
50960	289	
50966	292/309	
50980	32	
50982	32	
50983	28	
50985	28	
51017	60	
51018	60	
51020	60	
51021	60	
51028	156	
51033	279	
51035	81	
51050	289	
51051	289	
51055	300	
51056	300	
51059	179	
51119	189	
51120	212	
51121	212	
51122	199	
51123	198	
51124	199	
51125	198	
51126	200	
51127	205	
51127R	205	
51131	163	



REF.	pág.	PVP
51138	203	
51140	203	
51206	132	
51207	132	
51210	133	
51211	133	
51212	133	
51213	133	
51214	135	
51215	136	
51216	137	
51218	137	
51219	136	
51220	135	
51221	135	
51222	138	
51225	135	
51226	136	
51227	136	
51231	203	
51235	269	
51238	268	
51239	268	
51245	135	
51246	295	
51253	248	
51258	119	
51259	195	
51260	26	
51261	26	
51262	205	
51262R	205	
51266	164/295	
51270	53	
51272	57	
51277	146	
51283	178	
51285	53	
51287	53	
51305	54	
51306	54	
51307	54	
51315	348	
51318	36	
51326	119	
51332	182	
51333	29	
51336	153	
51337	186	
51338	205	
51338R	205	
51339	210	
51340	241	
51341	144/218	
51347	216	
51349	202	

REF.	pág.	PVP
51352	183	
51353	183	
51354	184	
51355	64/300	
51356	254	
51358	304	
51359	304	
51360	165	
51361	165	
51362	304	
51363	268	
51364	203	
51365	268	
51368	196	
51369	196	
51378	78	
51382	53	
51383	146	
51384	26	
51385	144	
51386	144	
51387	144	
51388	137	
51389	137	
51390	137	
51391	137	
51392	137	
51393	137	
51398N	175/309	
51400	186	
51401	186	
51402	186	
51403	186	
51405	54	
51406	54	
51409	26	
51410	26	
51412	296	
51414	196	
51416	303	
51419	80	
51422	80	
51439	137	
51440	137	
51441	137	
51442	137	
51443	144	
51444	144	
51445	144	
51446	119/294	
51447	56	
51448	56	
51452	264	
51456	80	
51479	57	
51488	241	

REF.	pág.	PVP
51489	241	
51490	198	
51491	188	
51493	188	
51494	186	
51495	193	
51496	194	
51499	186	
51500	196	
51501	197	
51504	48	
51525	57	
51526	57	
51528	42	
51529	40	
51538	324	
51539	324	
51540	324	
51541	324	
51542	324	
51543	324	
51544	324	
51545	324	
51546	324	
51554	324	
51570	86	
51573	119/294	
51574	83	
51575	83	
51576	80	
51600	83	
51604	300	
51612	129	
51613	129	
51614	129	
51615	129	
51616	24	
51617	25	
51622	175	
51632N	175/309	
51633	175/309	
51634	175/309	
51636N	175/309	
51638N	175/309	
51640N	175/309	
51642N	175/309	
51653	80	
51654	80	
51655	80	
51656	80	
51657	80	
51658	80	
51659	38	
51661	55/303	
51674	48	
51680	290	

REF.	pág.	PVP
51681	290	
51691	290	
51692	290	
51693	290	
51694	290	
51696	290	
51697	293	
51703	306	
51705	306	
51706	306	
51707	306	
51708	306	
51709	306	
51710	306	
51711	306	
51712	306	
51713	306	
51714	306	
51715	306	
51716	306	
51717	306	
51718	306	
51719	306	
51720	306	
51721	306	
51722	306	
51723	306	
51724	306	
51725	306	
51726	306	
51727	306	
51737	81	
51738	81	
51741	303	
51742	303	
51743	303	
51745	308	
51746	32	
51747	41	
51750	265	
51751	266	
51785	308	
51795	65	
51796	65	
51797	65	
51798	65	
51799	324	
51801	55	
51804	322	
51805	56	
51812	61	
51814	293	
51816	269	
51817	292/309	
51818	18	
51819	15	

REF.	pág.	PVP
51824	174	
51830	206	
51831	272	
51832	165	
51837	275	
51838	275	
51839	180/271	
51842	269	
51843	324	
51853	49	
51855	24	
51858	297	
51859	272	
51861	136/305	
51863	297	
51864	42	
51878	41	
51879	41	
51886	128	
51889	115	
51890	30/43	
51893	191	
51895	257	
51896	189	
51897	189	
51898	189	
51899	189	
51901	261	
51902	197	
51905	258	
51906	258	
51907	258	
51908	301	
51909	47	
51918	48	
51919	207	
51920	208/326	
51921	53	
51923	183	
51925	293	
51927	242	
51928	252	
51929	128	
51930	25	
51934	183	
51935	295	
51936	295	
51937	295	
51943	228	
51951	49	
51952	45	
51953	45	
51955	44	
51958	207	
51960	124	
51961	124	

REF.	pág.	PVP
51962	123	
51963	123	
51964	123	
51965	123	
51966	124	
51967	125	
51968	125	
51969	125	
51972	59	
51973	297	
51975	80	
51976	80	
51978	173	
51980	145	
51981	145	
51982	287	
51983	287	
51984	287	
51985	174	
51986	208	
51989	215	
51991	197	
51995	62/63	
51996	204	
51998	192	
51999	204	
52009	34	
52010	200	
52012	207	
52013	50	
52014	50	
52016	190	
52017	190	
52018	190	
52019	190	
52021	190	
52022	190	
52023	190	
52024	190	
52025	190	
52026	165	
52027	318	
52028	320	
52029	320	
52030	323	
52031	322	
52032	323	
52033	327	
52043	321	
52044	319	
52047	129	
52048	129	
52049	50	
52050	63	
52052	61	
52053	329	

REF.	pág.	PVP
52054	329	
52055	264	
52056	207	
52057	174	
52058	174	
52059	32	
52060	32	
52065	174	
52066	217	
52068	44	
52069	268	
52070	268	
52071	268	
52072	44	
52076	192	
52077	165	
52148	84	
52149	287	
52152	59	
52153	192	
52156	142	
52157	143	
52158	322	
52159	143	
52160	143	
52162	271	
52163	324	
52165	142	
52167	142	
52169	46	
52170	46	
52171	143	
52172	74	
52180	48	
52181	48	
52182	48	
52183	48	
52184	48	
52185	48	
52186	48	
52188	49	
52190	196	
52191	180	
52195	274	
52197	54	
52198	31	
52200	289	
52201	288	
52202	288	
52207	53	
52227	214	
52230	176/288	
52231	271	
52233	269	
52235	66	
52236	66	

REF.	pág.	PVP
52237	66	
52238	66	
52241	261	
52242	254	
52243	254	
52244	173	
52254	121	
52259	293	
52262	169	
52263	169	
52264	169	
52265	169	
52269	184	
52270	201	
52271	241	
52272	61	
52273	188	
52275	180	
52293	195	
52295	169	
52296	200	
52297	200	
52298	200	
52302	126	
52303	126	
52304	258	
52305	192	
52308	86	
52309	86	
52310	309	
52311	183	
52312	183	
52313	183	
52314	183	
52315	180	
52316	194	
52317	194	
52318	214	
52319	214	
52320	32	
52321	170	
52327	170	
52328	180	
52329	245	
52330	178	
52331	142	
52337	152	
52338	153	
52339	155	
52340	155	
52341	152	
52342	153	
52343	154	
52344	155	
52345	152	
52346	152	



REF.	pág.	PVP
52347	156	
52348	156	
52349	66	
52350	66	
52351	66	
52352	66	
52353	66	
52354	66	
52355	66	
52357	66	
52358	66	
52362	130	
52363	130	
52364	130	
52365	130	
52366	130	
52367	130	
52368	130	
52369	130	
52370	130	
52371	130	
52373	80	
52375	124	
52378	144/218	
52381	147	
52382	270/284	
52384	115	
52385	167	
52386	167	
52387	167	
52388	167	
52389	64/180	
52390	167	
52391	254	
52392	254	
52393	74	
52412	61	
52414	126	
52415	126	
52416	184	
52417	184	
52418	24	
52419	80	
52420	80	
52421	80	
52422	162	
52424	65	
52425	48	
52426	48	
52427	48	
52428	248	
52430	308	
52432	201	
52433	206	
52434	180	
52436	272	

REF.	pág.	PVP
52439	270	
52445	308	
52450	271	
52451	41	
52452	245	
52453	245	
52454	203	
52455	180	
52456	123	
52458	128	
52460	49	
52461	49	
52462	51	
52463	51	
52464	51	
52466	218	
52467	218	
52468	57	
52472	57	
52473	57	
52474	168	
52475	168	
52476	168	
52477	168	
52478	168	
52479	168	
52480	168	
52481	168	
52482	168	
52483	168	
52484	168	
52485	168	
52486	168	
52487	168	
52488	190	
52489	191	
52490	146	
52491	146	
52493	293/313	
52494	202	
52495	208	
52497	217	
52498	252	
52500	44	
52502	166	
52503	166	
52504	166	
52505	166	
52506	166	
52507	166	
52508	63	
52509	63	
52510	166	
52511	166	
52512	166	
52514	266	

REF.	pág.	PVP
52515	64/215	
52516	218	
52517	218	
52518	183	
52519	34	
52521	33	
52524	56	
52525	56	
52526	56	
52527	143	
52528	139	
52530	298	
52533	169	
52534	298	
52535	298	
52536	115	
52538	29	
52539	29	
52540	137	
52541	198	
52542	84	
52543	145	
52544	156	
52545	156	
52546	155	
52547	152	
52550	28	
52551	202	
52552	305	
52555	119	
52558	119	
52565	48	
52566	126	
52567	126	
52568	126	
52569	126	
52570	309	
52571	309	
52572	309	
52573	309	
52574	139	
52575	52/139	
52583	206	
52585	54	
52586	54	
52587	54	
52588	54	
52589	169	
52591	216	
52592	216	
52593	216	
52595	51	
52596	51	
52597	51	
52598	106/277	
52599	191	

REF.	pág.	PVP
52600	283	
52601	248	
52603	27	
52604	27	
52605	27	
52606	27	
52607	185	
52608	185	
52609	52	
52613	214	
52615	183	
52616	242	
52617	185	
52618	294	
52619	63	
52620	217	
52621	214	
52622	187	
52624	196	
52625	64/180	
52626	198	
52627	198	
52628	252	
52629	187	
52633	306	
52634	80	
52635	80	
52636	178	
52637	204	
52638	64	
52639	197	
52640	197	
52641	197	
52642	198	
52643	274	
52644	306	
52645	306	
52646	306	
52648	145	
52649	303	
52650	303	
52652	302	
52653	302	
52654	303	
52655	304	
52656	304	
52657	304	
52658	304	
52659	304	
52660	305	
52661	305	
52662	302	
52663	302	
52664	304	
52665	300	
52666	300	

REF.	pág.	PVP
52667	300	
52668	300	
52669	300	
52670	300	
52671	300	
52672	300	
52673	302	
52675	141	
52676	141	
52677	184	
52678	184	
52685	190	
52687	210	
52690	195	
52691	194	
52692	264	
52693	212	
52694	152	
52696	215	
52697	215	
52699	198	
52700	194	
52703	321	
52711	321	
52713	18	
52714	31	
52715	31	
52716	31	
52717	31	
52718	143	
52719	324	
52721	17	
52722	17	
52723	17	
52724	139	
52725	139	
52727	200	
52728	200	
52729	200	
52730	200	
52731	200	
52732	200	
52733	200	
52734	212	
52735	150	
52736	150	
52737	150	
52738	309	
52739	309	
52740	122	
52742	297	
52748	45	
52749	171	
52753	28	
52754	190	
52757	215	

REF.	pág.	PVP
52758	141	
52760	64/215	
52761	59	
52762	59	
52765	169	
52767	138	
52768	292	
52769	292	
52770	292	
52771	292	
52772	292	
52773	292	
52774	292	
52775	292	
52776	292	
52777	292	
52778	292	
52779	292	
52780	292	
52781	292	
52782	292	
52783	292	
52786	58	
52787	147	
52788	164	
52789	251	
52791	62/63	
52793	206	
52794	206	
52795	292	
52796	207	
52797	251	
52798	146	
52801	188/251	
52802	193	
52804	244	
52805	244	
52806	244	
52807	244	
52809	183	
52810	155	
52811	155	
52812	63	
52813	188	
52814	134	
52815	192	
52816	192	
52817	192	
52818	302	
52819	242	
52820	189	
52821	186	
52822	189	
52823	193	
52824	140	
52827	124	

REF.	pág.	PVP
52828	124	
52829	305	
52830	49	
52831	49	
52832	195	
52833	194	
52834	201	
52835	201	
52836	122	
52838	128	
52839	128	
52842	303	
52843	124	
52845	266	
52846	61	
52847	61	
52848	128	
52849	204	
52850	187	
52851	165	
52852	64	
52857	346	
52858	187	
52861	130	
52862	130	
52863	130	
52864	130	
52865	130	
52866	130	
52867	130	
52869	86	
52870	86	
52871	86	
52873	206	
52874	197	
52875	197	
52876	162	
52877	58	
52878	58	
52879	58	
52880	55/303	
52881	55/303	
52882	162	
52883	116	
52884	269	
52885	64	
52886	330	
52887	330	
52888	335	
52889	332	
52890	333	
52891	333	
52892	332	
52893	333	
52894	332	
52895	334	

REF.	pág.	PVP
52896	330	
52897	334	
52898	334	
52899	331	
52900	331	
52901	331	
52902	283	
52903	283	
52904	206	
52905	58	
52906	179	
52908	31	
52909	31	
52910	124	
52912	42	
52913	205	
52914	158	
52915	158	
52916	158	
52917	158	
52918	158	
52919	158	
52920	158	
52921	158	
52922	158	
52923	158	
52924	159	
52925	159	
52926	159	
52927	159	
52928	159	
52929	159	
52930	159	
52931	159	
52932	159	
52933	159	
52934	160	
52935	160	
52936	160	
52937	160	
52938	160	
52939	160	
52940	160	
52941	160	
52942	160	
52943	160	
52944	160	
52945	160	
52946	124	
52948	52	
52949	52	
52950	52	
52951	52	
52952	270/284	
52953	144	
52955	66	



REF.	pág.	PVP
52956	66	
52957	66	
52958	66	
52959	66	
52960	66	
52961	195	
52962	192	
52963	253	
52964	60	
52965	60	
52966	60	
52967	60	
52969	153	
52970	39	
52971	39	
52972	30/43	
52973	40	
52974	40	
52975	40	
52976	40	
52977	164	
52980	275	
52982	60/167	
52985	263	
52987	116	
52991	254	
52992	254	
52998	169	
52999	262	
53001	208	
53007	130	
53008	183	
53009	187	
53010	44	
53017	36	
53018	38	
53019	36	
53020	37	
53021	36	
53022	36	
53025	47	
53026	47	
53027	47	
53028	271	
53029	271	
53030	271	
53031	86	
53032	86	
53033	297	
53037	306	
53038	306	
53039	306	
53040	306	
53041	189	
53042	206	
53043	154	

REF.	pág.	PVP
53044	155	
53045	127	
53046	127	
53047	127	
53048	127	
53049	127	
53051	126	
53052	126	
53053	196	
53054	215	
53055	214	
53056	202	
53057	208	
53058	202	
53059	202	
53060	153	
53061	25	
53062	199	
53063	146	
53064	146	
53065	146	
53066	146	
53067	146	
53068	146	
53069	186	
53070	66	
53071	66	
53072	66	
53073	66	
53074	14	
53075	15	
53076	30	
53077	154	
53078	245	
53079	171	
53080	171	
53081	205	
53082	205	
53083	50	
53084	32	
53085	119	
53086	215	
53087	291	
53088	291	
53089	291	
53090	291	
53091	291	
53092	291	
53093	291	
53094	291	
53095	50	
53096	215	
53098	53	
53099	53	
53100	53	
53101	16	

REF.	pág.	PVP
53102	16	
53103	26	
53104	26	
53105	26	
53106	18	
53108	17	
53110	165	
53111	273	
53112	256	
53116	73	
53118	213	
53119	162	
53120	50	
53121	50	
53122	50	
53124	171	
53125	170	
53126	172	
53127	32	
53129	204	
53134	172	
53136	141	
53137	138	
53140	139	
53141	139	
53144	253	
53145	274	
53146	200	
53147	144	
53150	280/293	
53151	128	
53152	33	
53154	33	
53156	31	
53158	23	
53159	21	
53161	260	
53162	274	
53164	34	
53165	34	
53166	279	
53167	279	
53168	279	
53177	291	
53178	291	
53179	291	
53180	291	
53181	291	
53182	291	
53183	291	
53184	291	
53185	291	
53186	291	
53187	254	
53188	254	
53189	280	

REF.	pág.	PVP
53190	280	
53191	175	
53192	175	
53196	217	
53197	154	
53198	254	
53199	117/344	
53200	259	
53201	16	
53202	147	
53203	130	
53204	147	
53205	147	
53206	184	
53207	193	
53208	193	
53209	269	
53210	66	
53211	84	
53212	20	
53214	244	
53215	253	
53216	114	
53217	114	
53218	259	
53219	15	
53220	275	
53221	294	
53222	83	
53224	162	
53225	47	
53226	175	
53227	119	
53229	323	
53230	165	
53232	165	
53235	186	
53236	186	
53237	186	
53238	186	
53240	216	
53241	298	
53246	265	
53249	216	
53250	187	
53251	215	
53253	85/112	
53256	301	
53258	85/112	
53259	220	
53260	220	
53261	220	
53262	221	
53263	221	
53264	221	
53265	221	

REF.	pág.	PVP
53266	222	
53267	222	
53268	222	
53269	222	
53270	223	
53271	223	
53272	223	
53273	223	
53274	226	
53275	228	
53276	225	
53277	225	
53278	224	
53279	226	
53280	224	
53281	225	
53282	225	
53283	227	
53284	227	
53285	227	
53286	227	
53287	227	
53288	228	
53289	229	
53290	229	
53291	229	
53292	230	
53293	230	
53294	231	
53295	231	
53296	232	
53297	232	
53298	232	
53299	233	
53300	233	
53301	233	
53302	234	
53303	234	
53304	234	
53305	234	
53306	235	
53307	235	
53308	236	
53309	236	
53310	237	
53311	237	
53312	237	
53313	236	
53314	236	
53315	240	
53316	235	
53317	242	
53318	241	
53319	235	
53320	241	
53321	242	

REF.	pág.	PVP
53323	241	
53324	231	
53325	242	
53326	226	
53327	226	
53328	193	
53330	188	
53331	52	
53332	52	
53339	49	
53340	323	
53343	138	
53344	138	
53346	54	
53347	211	
53348	318	
53349	318	
53350	318	
53351	319	
53352	319	
53353	325	
53354	320	
53355	328	
53356	328	
53357	268/328	
53358	328	
53359	327	
53360	321	
53361	321	
53362	320	
53363	319	
53364	319	
53365	321	
53366	320	
53367	328	
53368	328	
53369	320	
53370	318	
53371	319	
53372	318	
53373	325	
53374	326	
53376	326	
53377	322	
53378	328	
53380	329	
53381	325	
53382	325	
53383	325	
53384	198	
53385	59/337	
53388	200	
53389	60	
53390	62	
53391	201	
53392	208	

REF.	pág.	PVP
53393	201	
53394	213	
53395	217	
53396	62	
53399	47	
53400	47	
53401	47	
53402	47	
53403	47	
53404	47	
53405	47	
53406	47	
53407	47	
53408	47	
53409	47	
53410	208	
53411	58	
53412	58	
53414	164	
53415	164	
53416	145	
53417	145	
53418	145	
53419	303	
53420	42	
53421	256	
53422	256	
53423	265	
53426	190	
53427	119	
53428	125	
53429	125	
53430	160	
53434	327	
53441	183	
53443	293	
53444	23	
53445	59	
53449	145	
53450	145	
53452	232	
53453	250	
53456	209	
53457	209	
53459	209	
53463	203	
53464	324	
53465	114	
53466	114	
53467	114	
53468	56	
53469	73	
53470	156	
53472	185	
53473	185	
53474	216	

REF.	pág.	PVP
53477	217	
53478	56	
53479	56	
53480	56	
53481	56	
53484	272	
53485	211	
53486	162	
53487	63	
53488	214	
53489	190	
53490	191	
53492	144/348	
53499	209	
53500	209	
53501	187	
53502	194	
53503	271	
53504	345	
53505	121	
53506	121	
53507	296	
53508	296	
53509	73	
53510	346	
53511	346	
53512	346	
53513	346	
53514	73	
53516	125	
53517	58	
53518	245	
53519	115	
53520	132	
53522	187	
53523	229	
53524	65	
53525	217	
53526	279/286	
53530	116/210	
53531	152	
53532	148/286	
53533	344	
53536	128	
53537	185	
53538	185	
53539	210	
53540	291	
53541	139	
53542	140	
53543	280	
53545	182	
53547	60	
53548	60	
53549	60	
53550	60	



REF.	pág.	PVP
53554	17	
53556	73	
53557	73	
53561	296	
53565	19/83	
53566	250	
53567	140/169	
53568	118	
53569	118	
53570	120	
53572	140/212	
53573	143	
53574	29/44	
53575	46	
53576	141	
53577	73	
53579	73	
53580	73	
53581	148/286	
53582	148/286	
53583	148/286	
53584	279/286	
53585	279/286	
53586	279/286	
53587	153	
53588	132	
53589	64	
53590	262	
53591	58	
53592	252	
53593	147	
53594	149	
53595	149	
53596	308	
53597	308	
53598	308	
53599	209/325	
53600	280	
53601	280	
53602	59	
53603	59	
53604	59	
53605	304	
53606	147	
53607	147	
53608	134	
53609	246	
53610	246	
53611	146	
53612	245	
53613	46	
53614	46	
53615	46	
53616	46	
53617	46	
53618	46	

REF.	pág.	PVP
53620	78	
53621	290	
53622	290	
53623	290	
53624	290	
53625	143	
53626	142/163	
53627	250	
53629	149	
53630	149	
53631	149	
53632	149	
53633	149	
53634	149	
53635	203	
53636	296	
53637	212	
53638	203	
53639	65	
53640	65	
53641	65	
53642	65	
53643	65	
53644	247	
53645	247	
53646	141	
53647	19	
53648	224	
53649	228	
53650	214	
53651	233	
53652	193	
53653	231	
53654	65	
53655	217	
53656	274	
53657	274	
53658	274	
53659	274	
53660	274	
53661	71	
53662	211	
53663	216	
53664	196	
53665	214	
53666	214	
53667	32	
53668	32	
53669	201	
53670	184	
53671	53	
53672	82	
53673	163	
53674	81	
53675	166	
53676	166	

REF.	pág.	PVP
53677	166	
53678	166	
53681	134	
53682	264	
53683	178	
53684	262	
53685	172	
53686	71	
53687	268	
53688	268	
53689	133	
53690	123	
53691	123	
53693	305	
53694	45	
53695	305	
53696	204	
53697	246	
53698	305	
53699	247	
53701	199	
53702	85/112	
53703	85/112	
53704	85/112	
53705	174	
53706	224	
53707	120	
53708	68-76	
53710	338	
53711	338	
53712	338	
53713	337	
53714	337	
53715	337	
53716	336	
53717	336	
53718	336	
53719	335	
53720	335	
53721	122/292	
53723	302	
53724	272	
53725	256	
53726	133	
53727	24	
53728	24	
53729	45/217	
53733	134	
53734	114	
53735	185	
53736	172	
53737	43	
53738	43	
53739	43	
53740	43	
53741	185	

REF.	pág.	PVP
53742	213/263	
53743	29/156	
53744	153	
53745	299	
53746	299	
53747	299	
53748	299	
53749	299	
53750	299	
53751	299	
53752	299	
53753	299	
53754	299	
53755	299	
53756	299	
53757	299	
53758	299	
53759	299	
53760	299	
53761	71	
53762	71	
53763	70	
53764	70	
53765	70	
53766	70	
53767	71	
53768	71	
53769	72/76/230	
53770	72/76/238	
53771	72/76/238	
53772	72/76/239	
53773	72/76/239	
53774	72/76/238	
53775	72/76/240	
53776	116	
53778	292	
53779	259	
53780	117	
53781	312	
53782	86/112	
53784	135	
53785	308	
53786	315	
53787	311	
53787O	311	
53788ES	309	
53790	313	
53791	313	
53794	310	
53795	310	
53796	315	
53797	311	
53798	310	
53802	316	
53803	313	
53804	313	

REF.	pág.	PVP
53805	315	
53806	316	
53808	314	
53809	314	
53811	314	
53820	276	
53822	313	
53824	313	
53826	312	
53827	312	
53828	313	
53829	313	
53830	310	
53832	313	
53835	310	
53836	310	
53838	316	
53839	314	
53840ES	314	
53843ES	314	
53844	311	
53845	259	
53849	250	
53850	108	
53851	109	
53852	109	
53853	109	
53854	109	
53855	109	
53856	109	
53857	110	
53858	110	
53859	110	
53860	108	
53861	108	
53862	312	
53863	312	
53864	301	
53865	342	
53866	75	
53867	74	
53868	68	
53869	69	
53870	69	
53871	37	
53872	286	
53873	249	
53874	249	
53875	196/242	
53876	235	
53877	347	
53878	347	
53879	347	
53880	266	
53881	148/286	
53882	148/286	

REF.	pág.	PVP
53883	55	
53884	55	
53885	55	
53886	55	
53887	55	
53888	55	
53893	312	
53895	259	
53896	259	
53897	259	
53898	259	
53899	310	
53900	70	
53901	70	
53902	312	
53903	218	
53904	71	
53905	62	
53906	62	
53907	311	
53908	62	
53909	62	
53910	327	
53911	62	
53912	69	
53913	69	
53914	314	
53915	25/212	
53916	311	
53917	44	
53919	173	
53920	106/345	
53921	173	
53922	173	
53927	269	
53928	22	
53929	269	
53930	345	
53931	346	
53932	59	
53934	345	
53939	68	
53940	284/314	
53941	284/314	
53942	284/314	
53943	45/78	
53944	45/78	
53945	45/78	
53946	311	
53947	278	
53948	278	
53949	346	
53950	346	
53951	72/240	
53952	72/240	
53953	14	

REF.	pág.	PVP
53954	43	
53955	43	
53956	342	
53957	311	
53958	218	
53959	311	
53960	311	
53961	311	
53963	311	
53964	297	
53965	297	
53967	62	
53968	257	
53969	264	
53970	282	
53971	282	
53972	205	
53973	343	
53974	117	
53976	62	
53977	273	
53978	179	
53979	43	
53980	43	
53981	273	
53982	273	
53983	170	
53984	308	
53985	308	
53986	308	
53987	284/314	
53988	154	
53989	308	
53990	308	
53991	308	
53992	327	
53993	50	
53994	308	
53995	308	
53996	308	
53997	191	
53999	110	
54000	110	
54001	260	
54002	110	
54003	189	
54004	118	
54005	30/43	
54008	110	
54010	110	
54011	110	
54013	293	
54015	62	
54016	211	
54017	50	
54018	53	

REF.	pág.	PVP
54019	53	
54020	106/276	
54021	53	
54022	53	
54023	53	
54024	53	
54028	52	
54029	52	
54030	52	
54031	52	
54032	37	
54033	140	
54034	9	
54035	10	
54036	11	
54037	12	
54038	13	
54039	121	
54040	270	
54041	37	
54042	295	
54043	344	
54044	127	
54045	9	
54046	10	
54047	11	
54048	12	
54049	13	
54050	253	
54051	253	
54052	283	
54053	283	
54054	283	
54055	283	
54056	283	
54057	283	
54058	283	
54059	283	
54060	44	
54061	44	
54062	282	
54066	36	
54068	182	
54069	203	
54072	295	
54076	344	
54077	209	
54078	125	
60001	98	
60003	98	
60004	105	
60005	91	
60006	92	
60007	96	
60008	94	
60009	94	



# NOTAS

REF.	pág.	PVP
60010	95	
60011	96	
60012	107	
60013	107	
60015	107	
60016	107	
60017	107	
60018	88	
60019	95	
60020	92	
60022	97	
60023	93	
60024	91	
60025	91/107	
60026	91/107	
60027	102	
60028	94	
60029	103	
60030	104	
60031	103	
60032	100	
60033	93	
60034	90	
60035	105	
60036	89	
60037	99	
60038	100	
60039	102	
60040	104	
60041	99	
60042	101	
60043	101	
70001	340	
70002	340	
70003	340	
70004	340	
70005	340	
70006	340	
70007	340	
70008	340	
70009	340	
70010	340	
70011	340	
70012	340	
90003	145	
90004	145	
JBMWEXP	299	
METEXP	298/348	
SERIE124	305	
SERIE262	142	

\* Precios venta al público.  
Impuestos no incluidos.

\* Precios válidos hasta el 31  
de marzo de 2022, edición de  
nuevo catálogo, revisión de  
tarifa o agotar existencias.

# ¿TE FALTA ALGUNA PIEZA?



Encuéntrala en la **APP** de JBM



**FÁCIL**  
**RÁPIDO**  
**SENCILLO**

Sólo tienes que seguir estos pasos:



ABRE LA APP



HAZ CLIC EN EL QR



ENFOCA CON LA CÁMARA EL ICONO QR QUE QUIERAS DEL CATÁLOGO



SE ABRIRÁ EL DESPIECE



ENCUENTRA TU PIEZA



**DESCÁRGATELA**







# ELÉCTRICA CON BATERÍA

con una única batería apta para todas las herramientas

Con motor **BRUSHLESS**:  
mayor eficiencia, mayor vida útil,  
más velocidad y menos ruido.



**BRUSHLESS  
MOTOR**

Herramientas eléctricas sin cable,  
para un uso más cómodo y sin límites



consúltalas en la pág. 87



DISTRIBUIDOR



[www.jbmcamp.com](http://www.jbmcamp.com)

 /JBMprofessionaltools

 @jbmtools

 JBM Campllong S.L.U.

 JBM Campllong S.L.U.